



**STYLECREST®**

Mobile Home &  
Manufactured Housing  
Products

**800-945-4440**  
[www.stylecrest.com](http://www.stylecrest.com)

**The difference is your success.**

Steps



Skirting



HVAC

Set-Up



Doors

Windows



Plumbing



Appliances

Electrical



**\$15.00**



Choose Quality.

**Kinro**

by Lippert Components



by Lippert Components



**Windows**

When you choose Kinro, you're buying more than just a window. You're getting a timeless and elegant view that will add beauty to your home, inside and out. From the beginning, Kinro has built sophisticated windows and doors that do more than provide a pretty view — every product detail contributes to the safety, comfort and quality of your home.

[kinro.com](http://kinro.com)



**Doors**

Every Kinro door is an attractive gateway to new adventure every morning and a secure, warm welcome home. For many years Kinro has led the way in providing the most excellent aluminum windows and doors because we guarantee quality construction, dependable service and innovative features.



**Kitchen & Bath**

The Better Bath name stands for quality, and our bath products have been the quality benchmark for more than thirty years. All our durable thermoformed bath products are designed to last! With multiple shapes, styles and back splashes, we provide a shower or bath configuration that is sure to add timeless elegance to your home.

[lippertcomponents.com](http://lippertcomponents.com)



**Minute Man Products, inc.**



**SPECIALIZING IN ANCHORING EARTHBOUND OBJECTS**

**PROUDLY MADE IN THE USA**



# LaSalle Bristol



LaSalle Bristol carries a complete line of name brand faucets for the Manufactured Housing markets including Utopia, our own brand manufactured in Plymouth, Indiana.



LaSalle Bristol offers a full line of named brand brass, copper, iron and plastic pipe and fittings, including our line of Utopia ABS, PVC and Polypropylene products.



Leading the industry in lighting products for 25 years, LaSalle Bristol proudly offers a wide range of Essential and Designer products with a strong focus on quality and styling.

## FAUCETS

KITCHEN & LAVATORY

## PIPE & FITTING

PEX, ABS, PVC, PEX, RISERS & VALVES

## LIGHTING

& FANS

**“WE PROUDLY CARRY  
ELIXIR DOORS”**



# ELIXIR

DOOR COMPANY

*A Division of Elixir Door & Metals Company*

**Made In America**



# E-Z Access<sup>®</sup>

## Manufactured Housing Crawlspace Door



**Approximate Dimensions: Frame - 26" x 35" Door Opening 18" x 24"**

- Attractive
- Easy Installation
- Keyed Lock
- Paintable

Interior Access panels also Available

**E-Z Access<sup>®</sup> Crawlspace doors are designed for use with traditional or decorative rigid skirting**



(918)-245-0770 • [www.divplastics.com](http://www.divplastics.com)



## Hometown Reliability

Whether you need a reliable electric or gas water heater,  
American has the perfect model for you!

For more information on these products or other dependable water heaters  
from American, visit [www.americanwaterheater.com](http://www.americanwaterheater.com).



STYLECREST®

**Mission Statement For Our Customers:**

“To Combine Products & Service  
That Assures 100% Customer Satisfaction”

**Mission Statement For Our Associates:**

“To Entrust Our Associates with Responsibility,  
Resources, and Authority to Achieve Our Mission”

## Terms and Conditions of Sale

### Payment Options / Terms of Sale

STYLE CREST offers several payment options:

- Major credit card:  
Discover, Visa, Master Card, American Express



- C.O.D. - Company or certified check, money order
- Open account line of credit
- Sorry, personal checks are not accepted

C.O.D. (Company Check) and Open Account require that a new account credit application be completed to verify business owner, address, bank relationship, and trade references. Certain open account credit limits may require additional information such as Dunn & Bradstreet, company financials, personal guarantees and Equifax reports.

### Freight and Order Minimums

Delivery charges and freight minimums may apply depending on customer location and purchased quantities. Delivery freight charges provided when order is placed.

### Sales Tax

An executed sales tax exemption certificate must be on file in order to avoid sales tax being charged to any order. Sales tax is automatically added to an order without a valid sales tax exemption certificate on file.

### Damaged Items / Shortages

All items are carefully packed before shipment. If merchandise is damaged by the carrier, you must make note of it on the delivery receipt. In all cases, count the number of cartons received compared to the delivery receipt and sign accordingly. You must initiate damage claims at the time of delivery.

### Returns

Unless shipped in error, Style Crest® will not accept any merchandise for return without prior written authorization from Customer Service. Only products in our current offering, in good

resalable condition will be considered. All returns, (except when a direct result of a Style Crest® error) must be returned freight paid and will be charged a 15% restocking charge. Return requests beyond 30 days after invoice can not be considered.

### Pricing

Contact your Customer Service Team for pricing inquiries. Pricing is subject to change without notice.

**1-800-945-4440**

### Ordering Procedure

All orders can be placed with the Customer Service Team at:

**1-800-945-4440**

Online ordering available. Contact your Customer Service Team for details.

If you prefer, you can fax your orders. Contact your Customer Service Team for your FAX number. A personalized order form can be created.

**1-800-945-4440**

Please have part numbers and quantities ready for our Customer Service Team Members.

For first time purchasers, please have a copy of your Sales Tax Exemption Certificate available for fax transfer to our Accounting Department.

### Pick-Up Orders

Our hours of operation are 8:00 A.M. to 4:30 P.M. Monday through Friday. Please call in advance to ensure your order is pick-up ready.

### Warranty Statement:

Style Crest®, Inc. makes no warranties written, implied, or expressed, including implied warranties of merchantability and fitness for a particular purpose in this catalog. The only warranties applicable to these products are the warranties offered by the products manufacturer. Style Crest® reserves the right to change or discontinue products without notice. Actual product color may vary slightly from color representation.

### Note

Style Crest® makes every effort to stock the products needed in each unique market area. Not all products shown in the catalog are stocked at all locations, but can be made available. Some product specifications may change due to changes in manufacturing. Please contact your sales representative for information on specific product needs. The possession of this catalog does not constitute an offer to sell the products listed. No part of this book may be reproduced in any manner without the permission of Style Crest®, Inc.

# TABLE OF CONTENTS

<b>A</b>	<b>ITEMS TOO NEW TO INDEX</b> <i>Newest Items Available</i> .....	Pages A-I—A-II
<b>B</b>	<b>EXTERIOR PRODUCTS AND ACCESSORIES</b> <i>Steps, Skirting, Foundation Covers, Tools &amp; Accessories</i> .....	Pages B-1—B-49
<b>C</b>	<b>TRANSPORTATION</b> <i>Axle, Hub &amp; Spring Parts, Flags, Signs, Lights, Home Wrap</i> .....	Pages C-1—C-6
<b>D</b>	<b>SET-UP</b> <i>Anchors, Jacks &amp; Piers, Boards &amp; Wedges, Pier Pads, Pipe Strap, Poly Film</i> .....	Pages D-1—D-20
<b>E</b>	<b>HEATING &amp; AIR CONDITIONING</b> <i>Furnaces, Air Conditioners, Heat Pumps, Accessories</i> .....	Pages E-1—E-62
<b>F</b>	<b>ELECTRICAL</b> <i>Light Fixtures, Exhaust Fans, Cords, Switches, Appliance Receptacles</i> .....	Pages F1—F12
<b>G</b>	<b>APPLIANCES</b> <i>Kitchen, Laundry &amp; Accessories</i> .....	Pages G-1—G-10
<b>H</b>	<b>DOORS &amp; WINDOWS</b> <i>Exterior &amp; Interior Doors, Storm &amp; Screen Doors, Hardware, Locks, Trim &amp; Molding, Vinyl &amp; Aluminum Windows, Window Parts</i> .....	Pages H-1—H-72
<b>I</b>	<b>PLUMBING</b> <i>Winterizing Systems, Fittings, ABS, Steel &amp; Iron, Copper &amp; Brass Sch 40 PVC, PVC Sewer &amp; Drain, Fresh Water, Pipe Cement</i> .....	Pages I-1—I-10
<b>J</b>	<b>INTERIOR PLUMBING</b> <i>Pipe &amp; Fittings, Bathtubs, Surrounds, Toilets &amp; Accessories, Faucets, Kitchen &amp; Bath Accessories, Replacement Parts, Water Heaters &amp; Accessories</i> .....	Pages J-1—J-40
<b>K</b>	<b>TOOLS &amp; FASTENERS</b> <i>Bits, Utility Knives, Cutters, Drivers, Tool Kits, Hammers, Snips, Belts, Screws, Nails, Rosettes</i> .....	Pages K-1—K-4
<b>L</b>	<b>SEALANTS &amp; ADHESIVES</b> <i>Roof Coat &amp; Accessories, Caulks, Caulk Guns, Tapes, Bottom Board Repair, Fiberglass Fabric, Carpet Protector</i> .....	Pages L-1—L-6
<b>M</b>	<b>INDEX BY ALPHABET AND BY PART NUMBER</b> .....	Pages M-1—M-23





Home - Manufactured Home Products - Sliding & Soffit - About Us - Resource Library

MANUFACTURED PRODUCTS

ABOUT REVOLV®

HVAC EQUIPMENT WARRANTY

HVAC SERVICE DOCUMENTS

REVOLV HVAC REGIONAL STANDARDS

PRODUCT VIDEOS

PRODUCT CATEGORIES

HVAC

HVAC Repair Parts

Doors and Windows

Foundation Covers

Steps, Decks, and Rails

Exterior Wall Coverings

Plumbing

Electrical

Interior Doors and Trim

Sealants and Adhesives

Specialty Windows

Setup and Transportation

Tools and Fasteners

MANUFACTURED HOUSING PRODUCTS RESOURCE LIBRARY

NEWS & EVENTS

Style Crest Unveils Next Generation of Revolv HVAC Products

Shutters Offer a Quick Way to Refresh Home Design

Style Crest®, Inc. Acquires Atlantic Service & Supply

LMC – Lumbermans Merchandising Corporation

Tunica Manufactured Housing Show

Wallace Hardware

## Manufactured Housing Products

For more than 40 years, Style Crest has served the manufactured housing and mobile home industry with a variety of quality products. We are dedicated to product superiority by innovating the latest and best technology. Our products include HVAC units, entry steps, foundation covers, doors and windows – along with a wide assortment of plumbing and electrical needs. Each one designed to accommodate the unique needs of mobile homes, adding superior performance and unmistakable beauty and charm. Our line of Revolv® Indoor Comfort Products, for instance, provides integrated, precisely-charged AccuCharge® Systems engineered exclusively for a mobile home's requirement.



Click here to download our complete 2016 MH Catalog (50MB) or browse products online through the categories listed below.

Click here to download the 2016 MH Catalog (8MB).

### Please Choose a Category

<Prev 1 2 Next>



HVAC



HVAC Repair Parts



Doors and Windows



Foundation Covers



Steps, Decks, and Rails



Appliances



Exterior Wall Coverings



Plumbing



Electrical



Interior Doors and Trim



Sealants and Adhesives



Specialty Windows



Contact Us | Privacy Policy | Terms of Service | News | About Us | Events | Resources | Products | Incentive Programs

*Please visit our web site [www.stylecrestinc.com](http://www.stylecrestinc.com) for the latest updates and new products.*

# TOO NEW TO INDEX

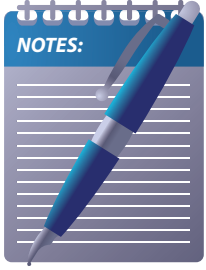

A large area of the page is filled with horizontal blue lines, providing space for writing or notes.

High Performance  
Materials, Design  
and Construction

Style Crest® entered the step  
manufacturing industry in 1970.

Our first generation of steps  
were redesigned to further  
enhance durability, safety  
and appearance. After many  
months of engineering and  
testing, Style Crest introduced  
the DuraGrip™II. The second  
generation of Style Crest  
Steps. This innovative design  
places Style Crest as a leader  
in Step Manufacturing. Today  
Style Crest Steps set the  
standard that all others are  
trying to achieve.

# ***DURA GRIP II***™ **Steps & Rails**



Style Crest®, Inc.  
2450 Enterprise St.  
Fremont, Ohio 43420



**10 Year Limited Warranty**

# DURA GRIP II™ STEPS

## High Performance Design, Materials and Construction

Most people know us as the leading manufacturer of high performance skirting. But Style Crest® actually started in 1970 by making steps. We decided it was time to rethink the whole idea of steps and what they mean to the appearance of today's more attractive manufactured homes. So we did extensive research on design, safety, colors, surfaces and styles. The result is the next generation of steps that are safer, more attractive, and easier for you to sell and install.

## High Performance Safety Surface

Our Dura-Grip II™ fiberglass step has a textured, slip resistant stone-like surface that gives better footing in all weather conditions. The receding riser gives the step 12" of surface for the foot and gives the unit a contemporary look.

## Faster Rail Mounts

Mounting rails is a snap. Just align the rail posts with the pre-drilled holes (that have steel sleeves so no drilling is required), and tighten the bolt. Takes 5 minutes, tops!

## Style Crest® Standard and Deluxe Railing Systems

Install Standard railings when you need economical choice. Choose the Deluxe extruded aluminum railing for added strength and safety. All Style Crest® rails meet or exceed most federal, state, and local code requirements. Contact Style Crest® with code requirements for your area.

## Custom Sizes Available

Style Crest® can manufacture steps to unique specifications. We can design & build a variety of sizes and styles. Contact your Style Crest® representative for details.



The Side Approach step shown with Deluxe Railing. Note: Side & back rails must be ordered separately. Use #0238 Standard Back Rail or #02938 Deluxe Back Rail.



The Economaster shown with Standard Rail.



The Economaster shown with Deluxe Railing.



**10 Year Limited Warranty**



Rail bumpers standard on all rail options.

# THE ECONOMASTER

*Our most popular straight approach fiberglass entry steps.  
Affordable, attractive, and durable.*



OPEN BACK



SHOWN WITH  
STANDARD RAIL



SHOWN WITH  
DELUXE RAIL



RAIL BUMPERS  
STANDARD ON  
ALL RAIL OPTIONS

PART NUMBER	RISER HEIGHT	OVERALL HEIGHT	LANDING DEPTH	WIDTH	STANDARD RAIL NUMBER	DELUXE RAIL NUMBER
017142436	7"	14"	24"	36"	02124	029124
018162436	8"	16"	24"	36"	02124	029124
017212436	7"	21"	24"	36"	02224	029224
018242436	8"	24"	24"	36"	02224	029224
017282436	7"	28"	24"	36"	02324	029324
018322436	8"	32"	24"	36"	02324	029324
017352436	7"	35"	24"	36"	02424	0294247
018402436	8"	40"	24"	36"	02424	029424
018482436	8"	48"	24"	36"	02524	029524

# THE ECONOMASTER DISPLAY UNIT

*This step is designed with built-in handles for easy moving between models on your retail display lot.*



SHOWN WITH  
STANDARD RAIL

ENCLOSED BACK



RAIL BUMPERS  
STANDARD ON  
ALL RAIL OPTIONS



SHOWN WITH  
DELUXE RAIL

PART NUMBER	RISER HEIGHT	OVERALL HEIGHT	LANDING DEPTH	WIDTH	STANDARD RAIL NUMBER	DELUXE RAIL NUMBER
018242436WHB	8"	24"	24"	36"	02224	029224
017282436WHB	7"	28"	24"	36"	02324	029324
018322436WHB	8"	32"	24"	36"	02324	029324
017352436WHB	7"	35"	24"	36"	02424	0294247
018402436WHB	8"	40"	24"	36"	02424	029424

# THE 48" WIDE

*A popular, mid-sized fiberglass step with full 29" platform.  
Twin railings recommended.*

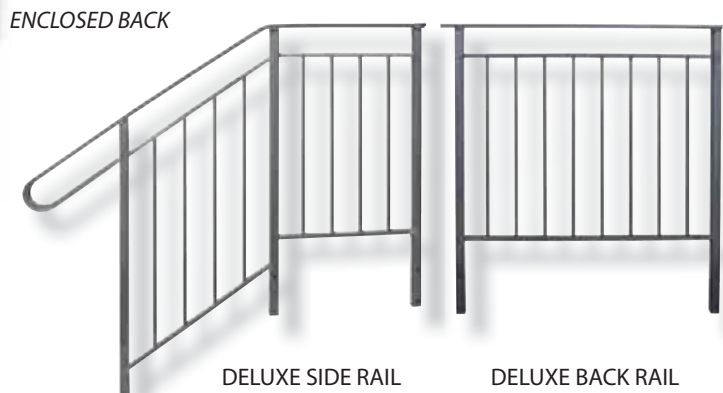
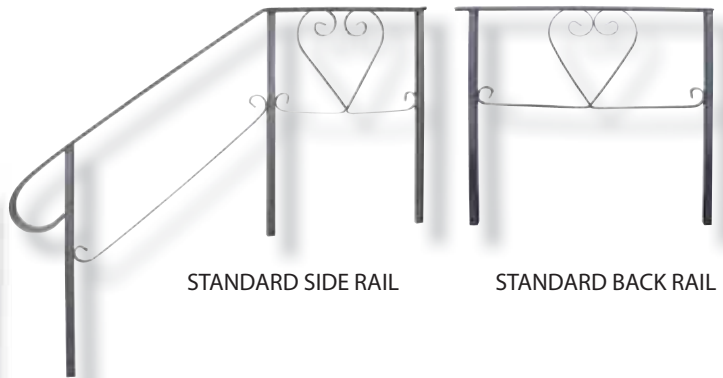

RAIL BUMPERS  
STANDARD ON  
ALL RAIL OPTIONS

PART NUMBER	RISER HEIGHT	OVERALL HEIGHT	LANDING DEPTH	WIDTH	STANDARD RAIL NUMBER	DELUXE RAIL NUMBER	STANDARD BACK RAIL	DELUXE BACK RAIL
018162948	8"	16"	29"	48"	02129	029129	0248	02948
017212948	7"	21"	29"	48"	02229	029229	0248	02948
018242948	8"	24"	29"	48"	02229	029229	0248	02948
017282948	7"	28"	29"	48"	02329	029329	0248	02948
018322948	8"	32"	29"	48"	02329	029329	0248	02948
017352948	7"	35"	29"	48"	02429	0294297	0248	02948
018402948	8"	40"	29"	48"	02429	029429	0248	02948

# THE 72" WIDE

Elegant approach with full 72" wide step and 29" deep platform for use with sliding glass and french doors. Twin railings recommended.



ENCLOSED BACK



STANDARD SIDE RAIL



DELUXE SIDE RAIL

RAIL BUMPERS  
STANDARD ON  
ALL RAIL OPTIONS



PART NUMBER	RISER HEIGHT	OVERALL HEIGHT	LANDING DEPTH	WIDTH	STANDARD RAIL NUMBER	DELUXE RAIL NUMBER
017142972	7"	14"	29"	72"	02129	029129
018162972	8"	16"	29"	72"	02129	029129
017212972	7"	21"	29"	72"	02229	029229
018242972	8"	24"	29"	72"	02229	029229
017282972	7"	28"	29"	72"	02329	029329
018322972	8"	32"	29"	72"	02329	029329
017352972	7"	35"	29"	72"	02429	0294297
018402972	8"	40"	29"	72"	02429	029429



# THE PLATFORM STEP

Use this full 38" x 38" or the 38" x 48" landing with reversible railing when you prefer a parallel approach.

Code approved in most areas

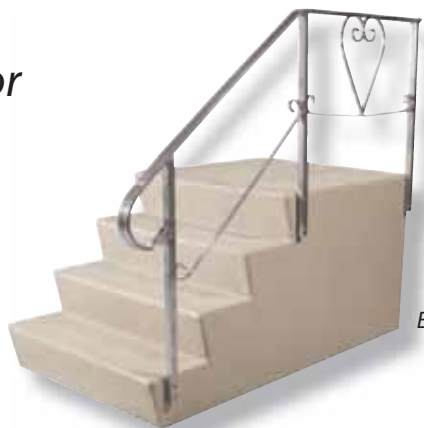

ENCLOSED BACK

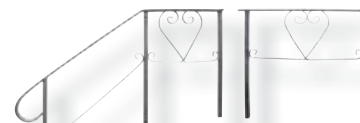

STANDARD SIDE AND BACK RAIL



DELUXE SIDE AND BACK RAIL

Shown with Standard Rails  
Note: Side & Back Rails must be Ordered Separately

RAIL BUMPERS  
STANDARD ON  
ALL RAIL OPTIONS



PART NUMBER	RISER HEIGHT	OVERALL HEIGHT	LANDING DEPTH	WIDTH	STANDARD SIDE RAIL	DELUXE SIDE RAIL	STANDARD BACK RAIL	DELUXE BACK RAIL
017143838	7"	14"	38"	38"	02138	029138	0238	02938
018163838	8"	16"	38"	38"	02138	029138	0238	02938
017213838	7"	21"	38"	38"	02238	029238	0238	02938
018243838	8"	24"	38"	38"	02238	029238	0238	02938
017283838	7"	28"	38"	38"	02338	029338	0238	02938
018323838	8"	32"	38"	38"	02338	029338	0238	02938
017353838	7"	35"	38"	38"	02538	0294387	0238	02938
018403838	8"	40"	38"	38"	02438	029438	0238	02938
017423838	7"	42"	38"	38"	N/A	0295387	N/A	02938
018483838	8"	48"	38"	38"	N/A	029538	N/A	02938
017493838	7"	49"	38"	38"	N/A	0296387	N/A	02938
018163848	8"	16"	38"	48"	02138	029138	0248	02948
018243848	8"	24"	38"	48"	02238	029238	0248	02948
017283848	7"	28"	38"	48"	02338	029338	0248	02948
018323848	8"	32"	38"	48"	02338	029338	0248	02948
017353848	7"	35"	38"	48"	02538	0294387	0248	02948
018403848	8"	40"	38"	48"	02438	029438	0248	02948

# ECONOMY STEPS

*As space conscious  
as it is cost conscious  
32" wide with a 14" landing*



RAIL BUMPERS  
STANDARD ON  
ALL RAIL OPTIONS



OPEN BACK

PART NUMBER	RISER HEIGHT	OVERALL HEIGHT	LANDING DEPTH	WIDTH	STANDARD RAIL NUMBER
018161432	8"	16"	14"	32"	02114M
018241432	8"	24"	14"	32"	02214M
018321432	8"	32"	14"	32"	02314M

**Not available in all locations**

**Special Order Sizes Available**  
Special Order call your sales representative for details!

## THE "B" SERIES

- 12" D x 36" W Treads and 18" D x 36" W Platform
- 8" Closed Cell Risers
- Optional Aluminum Rails
- Open Back

PART NUMBER	HEIGHT	RAIL MODEL
018161836	16"	02118
018241836	24"	02218
017281836	28"	02318
018321836	32"	02318

# Curb Appeal™ Collection

Foundation Covers Offering Performance and Beauty.

The Curb Appeal Collection allows you the choice of providing the best color and texture of foundation covers to complement the exterior setting of your home. Products that perform year after year while offering curb appeal that enhances the beauty of your home.



**PREMIUM Brand**  
LIFETIME  
Limited  
Manufacturer's  
WARRANTY

**PREMIUM PLUS SKIRTING**  
HIGH PERFORMANCE VINYL



**SKIRTING  
SAVER™**



**EAGLE**  
Vinyl Skirting  
**25 Year**  
Limited  
Manufacturer's  
Warranty

**EAGLE**  
Vinyl Skirting



Limited  
LIFETIME  
Manufacturer's  
**WARRANTY**



# NOVIK

SHAKES, STONE AND ACCENTS



**K-ROK**

K-ROK  
**5**  
YEAR  
ProRated  
WARRANTY

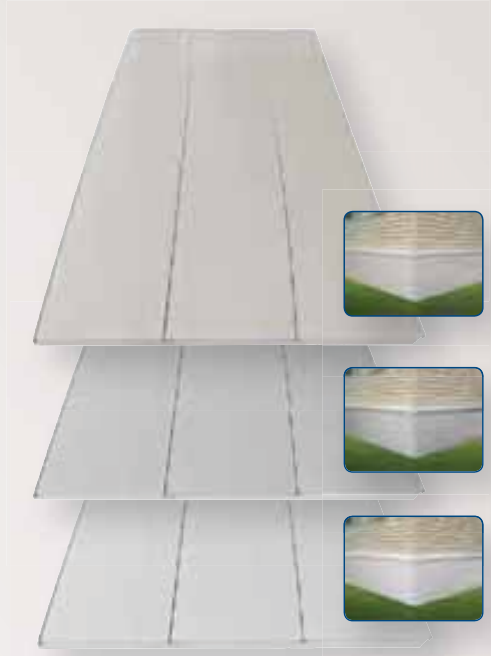

**RAPID WALL**  
FOUNDATION SYSTEMS  
BY **RUSTIQUE**

# ***PREMIUM PLUS SKIRTING***

## **HIGH PERFORMANCE VINYL**

- Available in .040 gauge White, Clay, Grey, Tan, Sand, Chocolate and Charcoal
- Solid and vented panels
- Finish that looks like freshly painted wood
- 16" wide panels for fast installation
- Durable-highest impact resistance for long life
- Rigorous QC program-consistent texture and performance
- Large trim kits-165' per kit

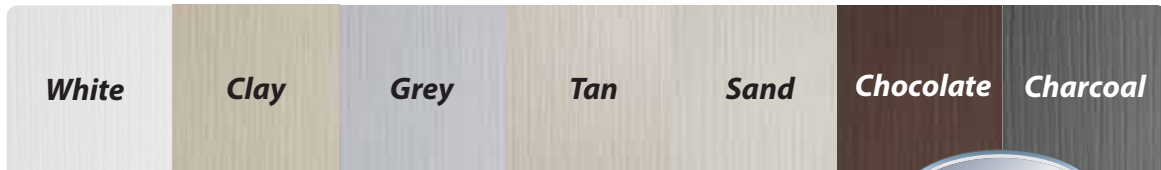

***Solid Panel***

***Center Vent Panel***

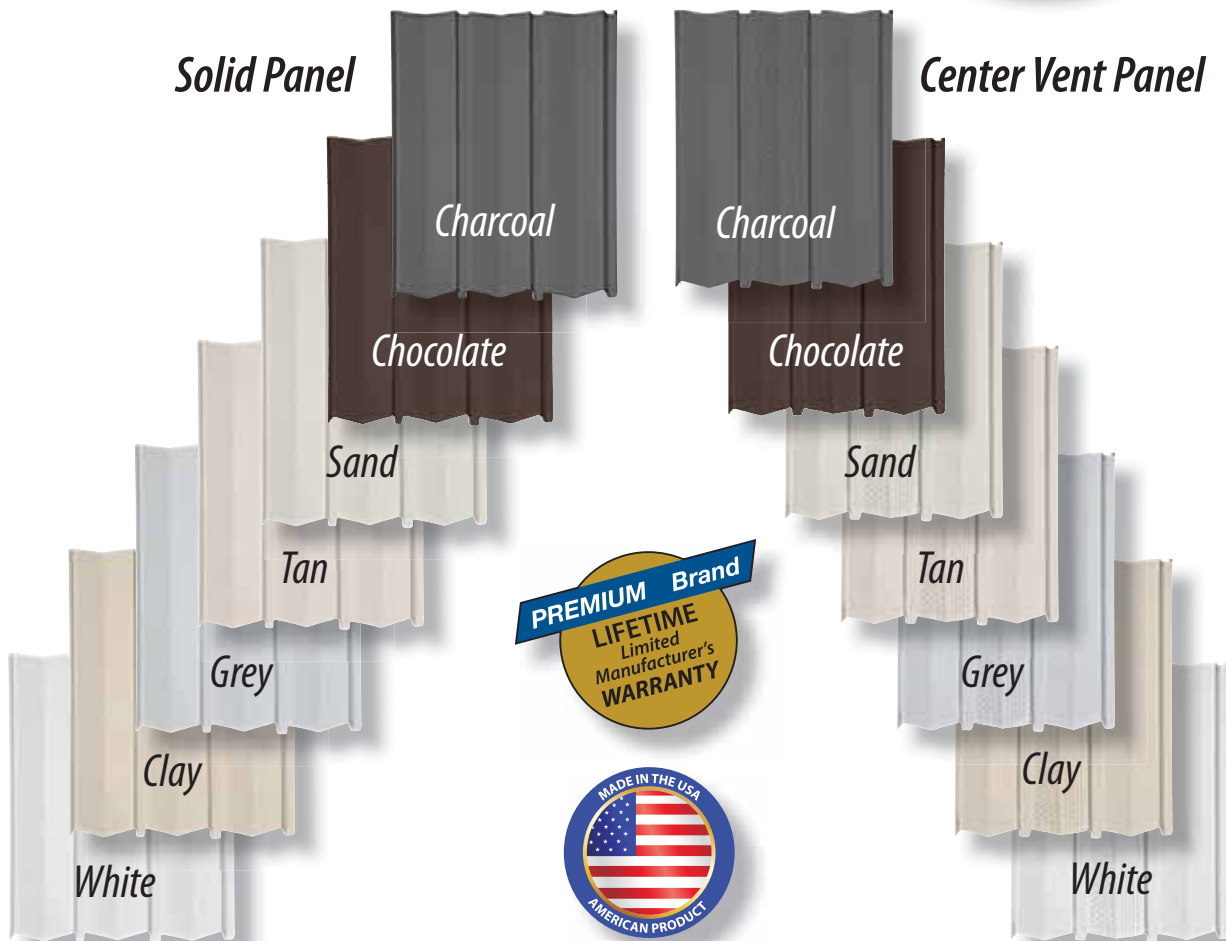

Product Availability, Prices and Specifications Subject to Change without Notice. Actual product color may vary slightly from color representation.

# PREMIUM PLUS SKIRTING

**HIGH PERFORMANCE VINYL**

Illustrations shown in Chocolate color

DESCRIPTION	PART NUMBER / COLOR	
PREMIUM PLUS PANEL CARTON CONTENTS 12 PCS. 16" BY 140" LONG 186.6 SQ. FT. / CTN. 64.42 LBS. PER CTN. .040 GAUGE	332061 White	
	332064 Clay	
	332063 Grey	
	332067 Tan	
	332068 Sand	
	332062 Chocolate*	
	332069 Charcoal*	
	PREMIUM PLUS CENTER VENT CARTON CONTENTS 12 PCS. 16" BY 140" LONG 186.6 SQ. FT. / CTN. 64.42 LBS. PER CTN. .040 GAUGE	333331 White
		333334 Clay
333333 Grey		
333337 Tan		
333338 Sand		
333332 Chocolate*		
333339 Charcoal*		



DESCRIPTION	PART NUMBER / COLOR	
PREMIUM PLUS TRIM KIT HARDWARE NOT INCLUDED TOP TRIM BACK 15 PCS. / 165 LIN. FT. TOP TRIM FRONT 15 PCS. / 165 LIN. FT. BOTTOM CHANNEL 15 PCS. / 165 LIN. FT. 83.78 LBS. PER CTN. .040 GAUGE	332211 White	
	332214 Clay	
	332213 Grey	
	332217 Tan	
	332218 Sand	
	332212 Chocolate*	
	332219 Charcoal*	
	PREMIUM PLUS BULK TOP TRIM FRONT 11' 1" PCS. — 50 PCS. / CTN. 102.34 LBS. PER CTN.	332031 White
		332034 Clay
332033 Grey		
332037 Tan		
332038 Sand		
332032 Chocolate*		
332039 Charcoal*		
PREMIUM PLUS BULK TOP TRIM BACK 132" EACH PCS. — 50 PCS. / CTN. 98.84 LBS. PER CTN.		332021 White
		332024 Clay
	332023 Grey	
	332027 Tan	
	332028 Sand	
	332022 Chocolate*	
	332029 Charcoal*	
	PREMIUM PLUS BULK BOTTOM CHANNEL 132" EACH PCS. — 50 PCS. / CTN. 76.69 LBS. PER CTN.	332011 White
		332014 Clay
332013 Grey		
332017 Tan		
332018 Sand		
332012 Chocolate*		
332019 Charcoal*		

Premium Center Vent Panel Offers 8.4 square inches Vent Per Lineal ft. of Vented Panel at *NO Additional Charge!*

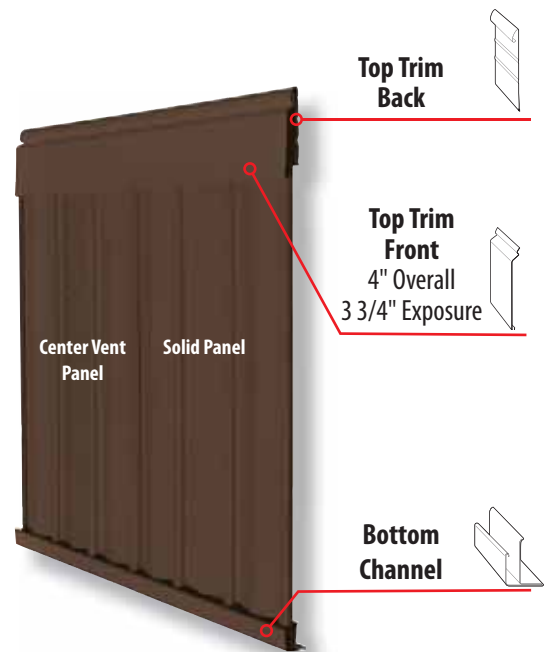

\* Charcoal and Chocolate colors feature Armor Coat™ Plus ASA capstock for great color retention



- Available in .035 gauge White, Clay, Grey, Tan, and Sand
- Solid and vented panels
- Finish that looks like freshly painted wood
- 16" wide panels for fast installation
- Durable-highest impact resistance for long life
- Rigorous QC program-consistent texture and performance
- Large trim kits-165' per kit

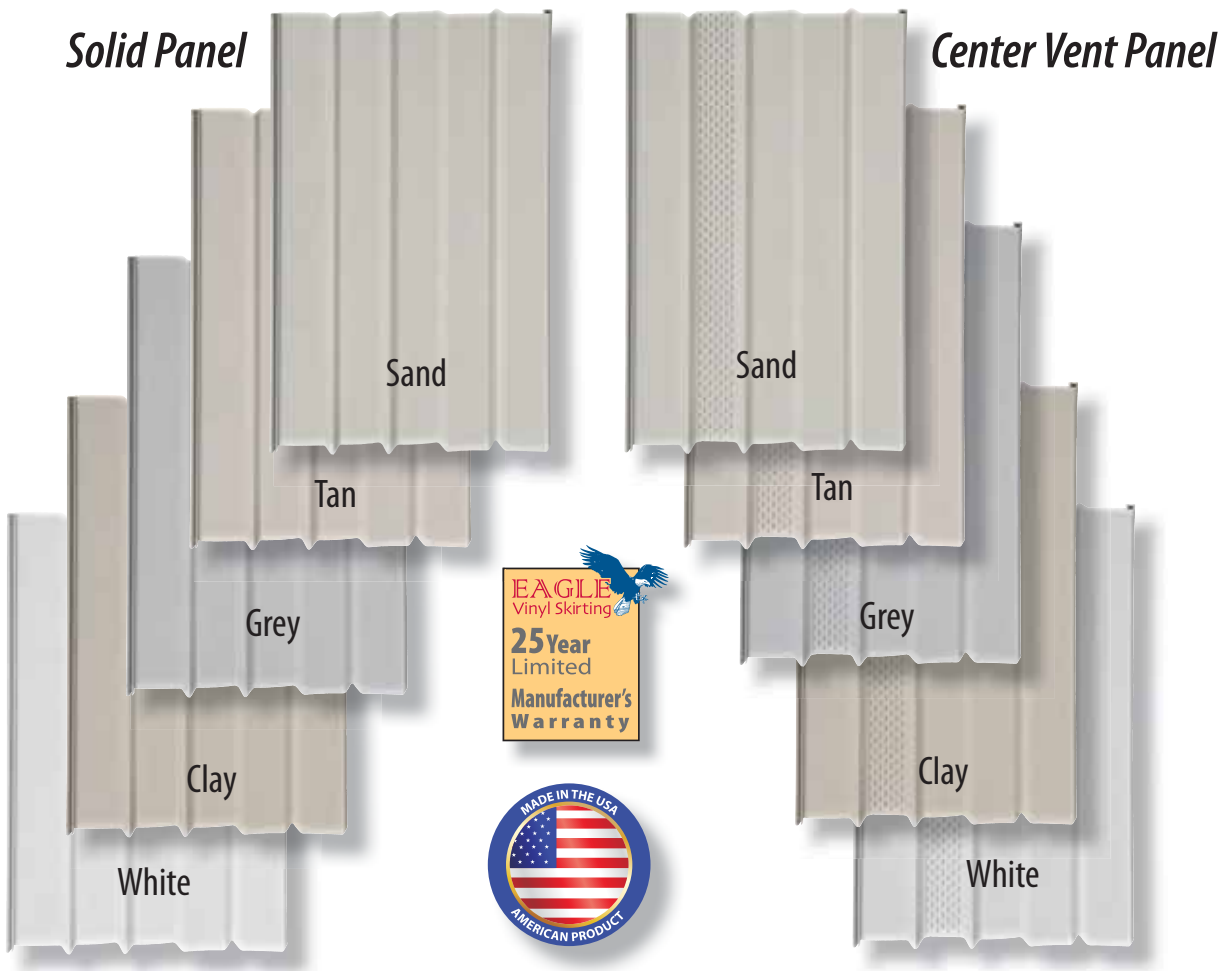

Product Availability, Prices and Specifications Subject to Change without Notice. Actual product color may vary slightly from color representation.



Illustrations shown in Clay color

DESCRIPTION	PART NUMBER / COLOR
EAGLE PANEL CARTON CONTENTS 12 PCS. 16" BY 140" LONG 186.6 SQ. FT. / CTN. 55.60 LBS. PER CTN. .035 GAUGE	343081 White
	343084 Clay
	343083 Grey
	343088 Sand
	343087 Tan
EAGLE CENTER VENT CARTON CONTENTS 12 PCS. 16" BY 140" LONG 186.6 SQ. FT./CTN. 55.60 LBS. PER CTN. .035 GAUGE	349991 White
	349994 Clay
	349993 Grey
	349998 Sand
	349997 Tan



DESCRIPTION	PART NUMBER / COLOR
EAGLE DELUXE TRIM KIT HARDWARE NOT INCLUDED TOP TRIM BACK 15 PCS. / 165 LIN. FT. TOP TRIM FRONT 15 PCS. / 165 LIN. FT. BOTTOM CHANNEL 15 PCS. / 165 LIN. FT. 68.48 LBS. PER CTN.	343251 White
	332214 Clay *
	343253 Grey
	343257 Tan
	343258 Sand
EAGLE DELUXE BULK TOP TRIM FRONT 132" EACH PIECE 50 PCS. / CTN. 78.84 LBS. PER CTN.	343051 White
	332034 Clay *
	343053 Grey
	343057 Tan
EAGLE DELUXE BULK TOP TRIM BACK 50 PCS. PER CTN. 80.29 LBS. PER CTN.	343058 Sand
	343021 White
	332024 Clay *
	343023 Grey
	343027 Tan
EAGLE DELUXE BULK BOTTOM CHANNEL 132" EACH PIECE 50 PCS. / CTN. 67.49 LBS. PER CTN.	343028 Sand
	343011 White
	332014 Clay *
	343013 Grey
	343017 Tan
	343018 Sand

\*Premium Only Available

Eagle Single Vent Panel Offers  
4.9 square inches Vent Per Lineal ft.  
of Vented Panel at NO Additional Charge!

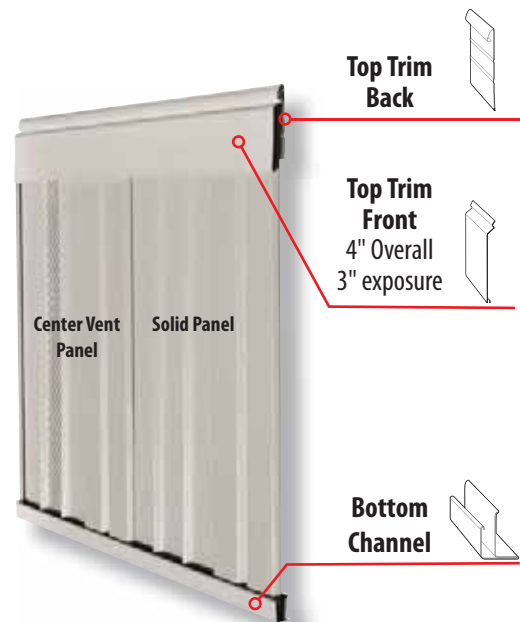



### ACCESS PANEL DOOR

TRACK MOUNT

- DURABLE, HIGH IMPACT WHITE PLASTIC
- MAY BE PAINTED ANY COLOR
- BUILT IN KEY LOCK
- FITS 2 STANDARD SKIRTING PANELS
- MOUNTED INTO BOTTOM TRACK WITH SPECIAL SECTION TO ENGAGE SECURELY INTO TRACK



291824M ACCESS DOOR 18" x 24" TRACK MOUNT

### ACCESS PANEL DOOR

FLANGE MOUNT

- DURABLE, HIGH IMPACT WHITE PLASTIC
- MAY BE PAINTED ANY COLOR
- BUILT IN KEY LOCK
- FITS 2 STANDARD SKIRTING PANELS
- WIDE FLANGE ON ALL SIDES ALLOWING IT TO BE MOUNTED IN APPLICATIONS WHERE NO BOTTOM TRACK IS USED



291824S ACCESS DOOR 18" x 24" FLANGE MOUNT

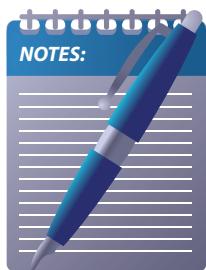

---

---

---

---

---

---

---

---

---

---

**JIG**

FOR CUTTING VINYL PANELS



33401 JIG

**SNAP LOCK PUNCH**

FOR VINYL ONLY



623764 1/2" THROAT DEPTH  
8 1/2" LONG-3/CTN.

**SKIRT HANG'R**

METAL SKIRTING BRACKET

- EASILY ATTACHES TO RIM JOIST
- PRE-DRILLED AND SLOTTED
- GALVANIZED TO LAST A LIFETIME



3343779 METAL SKIRTING BRACKET  
50 PER CTN

**HARDWARE**

FOR VINYL SKIRTING



3350 100 - 8" SPIKES/200 1-1/2" NAILS  
3352 1 1/2" NAILS- 250/BOX  
3354 100 - 8" SPIKES & 200 #8 SCREWS  
3510 8" GROUND SPIKES- 200/BOX

**WIND STAY RODS**

ADDS ADDITIONAL BLOWOUT PROTECTION

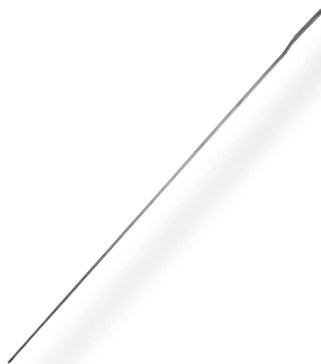

33412 12" LENGTH, 32 BDL.  
33424 24" LENGTH, 32 BDL.



**MANUFACTURED HOUSING**



- Keep your home looking nice!
- Save maintenance costs!
- Reduce yard work time and enjoy your summer!

EXCLUSIVELY FROM  STYLECREST.

## Keep Mechanical Grass Trimmers Away from Skirting!



**NEW!**

### Features:

- Maintain the beauty of your home
- Prolongs the life of your foundation cover/skirting
- Fast/Easy to install on new or existing homes
- Economical—low cost
- Stays in place throughout the year
- Prevents weeds and grass from growing close to your house



305044 SKIRTING SAVER™ PANEL

### SKIRTING SAVER™

PIECE LENGTH:	12' 6"
PIECE TOTAL WIDTH:	7.6"
EXPOSED WIDTH:	6"
PIECES PER CARTON:	30
APPROX. WEIGHT PER CARTON:	72 LBS.



305044 SKIRTING SAVER™ PANEL

Product Availability, Prices and Specifications Subject to Change without Notice. Actual product color may vary slightly from color representation.

## V-GUARD™ VINYL SKIRT PROTECTOR

Keep Vinyl Skirting Looking New! Maintains Value of Home • Easy to Install



- 332031 WHITE 50/CTN.\*
  - 332033 GREY 50/CTN.\*
  - 332034 CLAY 50/CTN.\*
  - 332037 TAN 50/CTN.\*
  - 332038 SAND 50/CTN.\*
  - 332032 CHOCOLATE 50/CTN.\*
  - 332039 CHARCOAL 50/CTN.\*
- \*EACH PIECE IS 11' 1" LONG

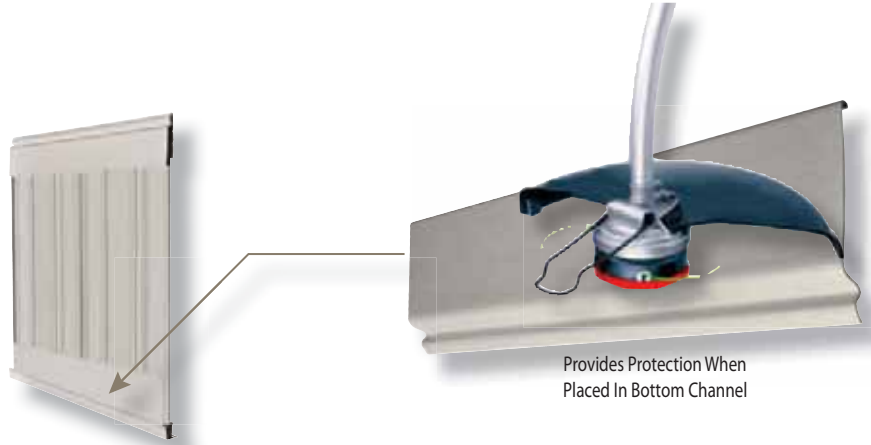

EAGLE/PREMIUM SKIRTING CALCULATOR (FOR 16" PANELS ONLY)												
<b>SINGLE WIDE HOMES</b>												
HOMES CALL SIZE (FT.)*	8 x 32	8 x 35	12 x 65	12 x 70	14 x 60	14 x 65	14 x 70	14 x 76	14 x 80	16 x 70	16 x 80	
PERIMETER LINEAL FEET**	80	86	146	156	140	150	160	172	180	164	184	
<b>TRIM COMPONENTS NEEDED-EACH TRIM COMPONENT IS 132" LONG</b>												
TOP TRIM BACK	8	8	14	15	13	14	15	16	17	15	17	
TOP TRIM FRONT	8	8	14	15	13	14	15	16	17	15	17	
BOTTOM CHANNEL	8	8	14	15	13	14	15	16	17	15	17	
<b>NUMBER OF PANELS NEEDED (EAGLE AND PREMIUM)-EACH PANEL IS 16" WIDE X 140" LONG</b>												
AVERAGE HEIGHT INCHES ***												
18	9	10	16	17	15	17	18	19	20	18	20	
23	10	11	19	20	18	19	20	22	23	21	23	
28	12	13	22	24	21	23	24	26	27	25	28	
35	15	17	28	30	27	29	30	33	34	31	35	
42	20	22	37	39	35	38	40	43	45	41	46	
<b>DOUBLE WIDE HOME</b>												
HOMES CALL SIZE (FT.)*	24 x 50	24 x 60	24 x 65	24 x 70	28 x 52	28 x 54	28 x 56	28 x 65	28 x 70	28 x 80	30 x 70	32 x 80
PERIMETER LINEAL FEET**	144	160	170	180	152	156	160	178	188	208	192	216
<b>TRIM COMPONENTS NEEDED-EACH TRIM COMPONENT IS 132" LONG</b>												
TOP TRIM BACK	14	15	16	17	14	15	15	17	18	19	18	20
TOP TRIM FRONT	14	15	16	17	14	15	15	17	18	19	18	20
BOTTOM CHANNEL	14	15	16	17	14	15	15	17	18	19	18	20
<b>NUMBER OF PANELS NEEDED (EAGLE AND PREMIUM)-EACH PANEL IS 16" WIDE X 140" LONG</b>												
AVERAGE HEIGHT INCHES ***												
18	16	18	19	20	17	17	18	20	21	23	21	24
23	18	20	22	23	19	20	20	23	24	26	24	27
28	22	24	26	27	23	24	24	27	29	32	29	33
35	27	30	32	34	29	30	30	34	36	39	36	41
42	36	40	43	45	38	39	40	45	47	52	48	54
* Includes hitch-typically 4' per section												
**Less hitch and additions-Note measure the complete perimeter of the home--- If skirting hitch, additional materials are required												
***Average height-measure all 4 corners at center of each side-if home is between sizes or heights-move to next largest calculation												
<b>Notes: Calculations shown are based on exact height and completely level ground.</b>												
Actual material needs may differ. Please add one or more panels for waste or errors												



# MASON'S™

COLLECTION

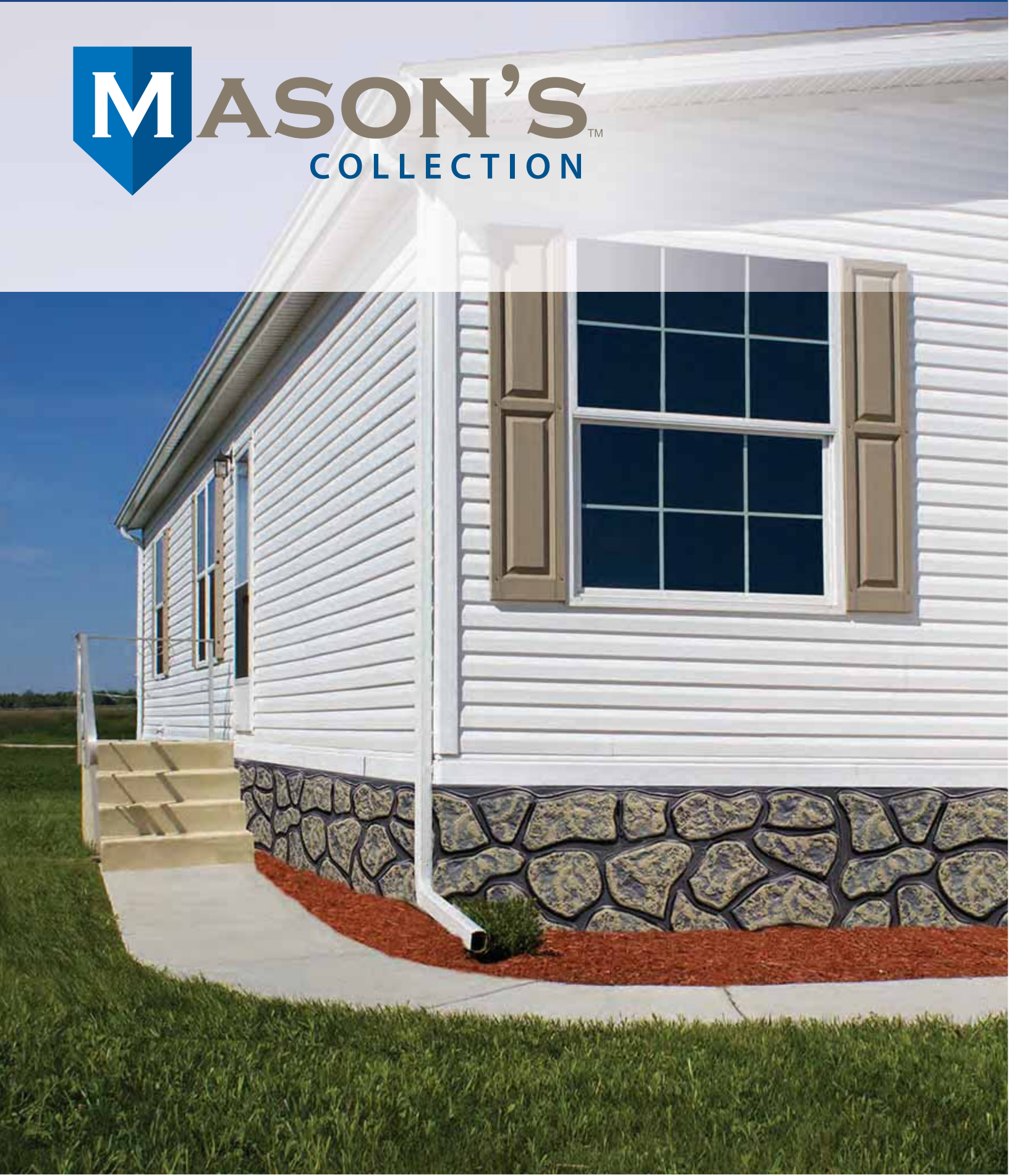



INTRODUCING

# MASON'S<sup>™</sup> ROCK

## Coming in 2017

- Beautifully designed for enduring curb appeal
- Compliments all home styles
- Authentic look
- Three panel height available
- Choose from two realistic colors
- Accessories available for a complete and secure installation
- Made in the USA



**Sedona Brown**



**Slate Gray**

Available Panel Height  
32" • 36" • 48"





CREATE AN ATTRACTIVE RUSTIC APPEARANCE WITH THIS SINGLE MOLDED A.B.S. MATERIAL. K-ROK SKIRTING WON'T SCRATCH, DENT, OR RATTLE.



**K-ROK PANELS**

- 2923259 32" x 5' PANEL GRANITE
- 2923255 32" x 5' PANEL SANDSTONE
- 2923257 32" x 5' PANEL BROWN
- 2923659 36" x 5' PANEL GRANITE
- 2923655 36" x 5' PANEL SANDSTONE
- 2923657 36" x 5' PANEL BROWN
- 2924859 48" x 5' PANEL GRANITE
- 2924855 48" x 5' PANEL SANDSTONE
- 2924857 48" x 5' PANEL BROWN

**FOUNDATION VENT INSERT**



- 29901 BLACK
- 29905 SANDSTONE

**SCREW**



- 2995 BLACK 1" 350/PKG.
- 29255 SANDSTONE 1" 350/PKG.

**ACCESS DOOR**

Outside View  
Keys Included  
Attached to Inside  
of Door



• Door Access Meets HUD CODE

- 29909 ACCESS DOOR 32" x 36" GRANITE
- 29955 ACCESS DOOR 32" x 36" SANDSTONE
- 29907 ACCESS DOOR 32" x 36" BROWN

**BOTTOM TRACK**



- 2925059 10' BOTTOM TRACK GRANITE
- 2925055 10' BOTTOM TRACK SANDSTONE
- 2925057 10' BOTTOM TRACK BROWN

**METAL STUDS**



- 293121592 METAL STUD 2 1/2" x 12' x 25 GA.
- 293121593 METAL STUD 3 5/8" x 12' x 25 GA.

Product Availability, Prices and Specifications Subject to Change without Notice. Actual product color may vary slightly from color representation.

## ACCESS PANEL DOOR

TRACK MOUNT

- DURABLE, HIGH IMPACT WHITE PLASTIC
- MAY BE PAINTED ANY COLOR
- BUILT IN KEY LOCK
- FITS 2 STANDARD SKIRTING PANELS
- MOUNTED INTO BOTTOM TRACK WITH SPECIAL SECTION TO ENGAGE SECURELY INTO TRACK



291824M ACCESS DOOR 18" x 24" TRACK MOUNT

## ACCESS PANEL DOOR

FLANGE MOUNT

- DURABLE, HIGH IMPACT WHITE PLASTIC
- MAY BE PAINTED ANY COLOR
- BUILT IN KEY LOCK
- FITS 2 STANDARD SKIRTING PANELS
- WIDE FLANGE ON ALL SIDES ALLOWING IT TO BE MOUNTED IN APPLICATIONS WHERE NO BOTTOM TRACK IS USED



291824S ACCESS DOOR 18" x 24" FLANGE MOUNT

## VENTS

AUTOMATIC VENT BROWN OR BLACK FITS 8" X 16" OPENING INSIDE DIM.: 7 7/8" X 15 3/4"



2996 Automatic Vent - Brown

2997 Automatic Vent - Black





*Lightweight yet rigid*

*Quick & easy to install*

*Perfect for skirting on manufactured homes*

With its stunning colors and textures, NovikStone was designed to offer attainable luxury to every homeowner.

#### Features include:

- Installs easily with traditional tools
- Resistant to warping, expansion, contraction and cracking
- Impervious to moisture - perfect for ground contact

Call 888-847-8057 or visit [Novik.com](http://Novik.com)



*NovikStone DS -  
Dry Stack Stone with its  
amazing look and feel is  
available in eight natural  
colors*



*NovikStone SK -  
Stacked Stone with its  
faithful render of natural  
stone is available in six  
colors*

# NOVIK

SHAKES, STONE AND ACCENTS



## HAND-LAID BRICK AND HAND-CUT STONE PATTERN PANELS

- *Extreme temperature variation resistance*
- *Resistance to warping, expansion, retraction and cracking*
- *Wind and impact (ASTM D4226) resistance*
- *Resistance to discoloration (U. V. rays)*
- *Fire rating (Class C) certified*
- *Seamless visual appearance*
- *Lightweight material, fast and easy to install*
- *Maintenance free*
- *Never needs to be painted*
- *Authentic brick and stone texture*
- *Ideal for feature walls, foundations or as an accent for interior rooms*
- *Harmonizes with all siding types*
- *Features that simplify installation*
- *Certified testing by independent laboratories*

## NOVIK PANELS AND MATCHING ACCESSORIES ARE AVAILABLE IN 3 BRICK AND 3 STONE COLORS

(SHOWN IN OLD RED BLEND)



### NOVIK HAND-LAID OLD RED BLEND BRICK PATTERN

PANEL SIZE: 48" X 18 1/2"  
MATERIAL THICKNESS: 0.090"  
PIECES PER CARTON: 9  
SQ. FT. PER CARTON: 50  
APPROX. WEIGHT PER CARTON: 43 LBS.



2310005214 HL BRICK PANEL OLD RED BLEND  
23120055214 HL BRICK CORNER OLD RED BLEND

### NOVIK HAND-LAID RED USED BLEND BRICK PATTERN

PANEL SIZE: 48" X 18 1/2"  
MATERIAL THICKNESS: 0.090"  
PIECES PER CARTON: 9  
SQ. FT. PER CARTON: 50  
APPROX. WEIGHT PER CARTON: 43 LBS.



2310005204 HL BRICK PANEL RED USED BLEND  
23120055204 HL BRICK CORNER RED USED BLEND

### NOVIK HAND-LAID BROWN BLEND BRICK PATTERN

PANEL SIZE: 48" X 18 1/2"  
MATERIAL THICKNESS: 0.090"  
PIECES PER CARTON: 9  
SQ. FT. PER CARTON: 50  
APPROX. WEIGHT PER CARTON: 43 LBS.



2310005205 HL BRICK PANEL BROWN BLEND  
23120055205 HL BRICK CORNER BROWN BLEND

**NOVIK HAND-CUT BARK BLEND STONE PATTERN**

PANEL SIZE: 48.2" X 18.6"  
 MATERIAL THICKNESS: 0.090"  
 PIECES PER CARTON: 9  
 SQ. FT. PER CARTON: 50  
 APPROX. WEIGHT PER CARTON: 40 LBS.



2310004213 HC STONE PANEL BARK BLEND  
 23120045213 HC STONE CORNER BARK BLEND

**NOVIK HAND-CUT DESERT BLEND STONE PATTERN**

PANEL SIZE: 48.2" X 18.6"  
 MATERIAL THICKNESS: 0.090"  
 PIECES PER CARTON: 9  
 SQ. FT. PER CARTON: 50  
 APPROX. WEIGHT PER CARTON: 40 LBS.



2310004209 HC STONE PANEL DESERT BLEND  
 23120045209 HC STONE CORNER DESERT BLEND

**NOVIK HAND-CUT CANYON BLEND STONE PATTERN**

PANEL SIZE: 48.2" X 18.6"  
 MATERIAL THICKNESS: 0.090"  
 PIECES PER CARTON: 9  
 SQ. FT. PER CARTON: 50  
 APPROX. WEIGHT PER CARTON: 40 LBS.



2310004208 HC STONE PANEL CANYON BLEND  
 23120045208 HC STONE CORNER CANYON BLEND

**NOVIK DS DRY STACKED STONE PATTERN**

PANEL SIZE: 41.5" X 13.13"  
 MATERIAL THICKNESS: 0.090"  
 PIECES PER CARTON: 10  
 SQ. FT. PER CARTON: 1/4 SQUARE  
 APPROX. WEIGHT PER CARTON: 20 LBS.



23100540002 DS DRY STACKED STONE PANEL BASALT  
 23120540002 DS DRY STACKED STONE CORNER BASALT

**NOVIK DS DRY STACKED STONE PATTERN**

PANEL SIZE: 41.5" X 13.13"  
 MATERIAL THICKNESS: 0.090"  
 PIECES PER CARTON: 10  
 SQ. FT. PER CARTON: 1/4 SQUARE  
 APPROX. WEIGHT PER CARTON: 20 LBS.



23100540004 DS DRY STACKED STONE PANEL BROWNSTONE  
 23120540004 DS DRY STACKED STONE CORNER BROWNSTONE

**NOVIK DS DRY STACKED STONE PATTERN**

PANEL SIZE: 41.5" X 13.13"  
 MATERIAL THICKNESS: 0.090"  
 PIECES PER CARTON: 10  
 SQ. FT. PER CARTON: 1/4 SQUARE  
 APPROX. WEIGHT PER CARTON: 20 LBS.



23100540006 DS DRY STACKED STONE PANEL ANTHRACITE  
 23120540006 DS DRY STACKED STONE CORNER ANTHRACITE

Product Availability, Prices and Specifications Subject to Change without Notice. Actual product color may vary slightly from color representation.

**NOVIK DS DRY STACKED STONE PATTERN**

41.5" X 13.13"  
 MATERIAL THICKNESS: 0.090"  
 PIECES PER CARTON: 10  
 SQ. FT. PER CARTON: 1/4 SQUARE  
 APPROX. WEIGHT PER CARTON: 20 LBS.

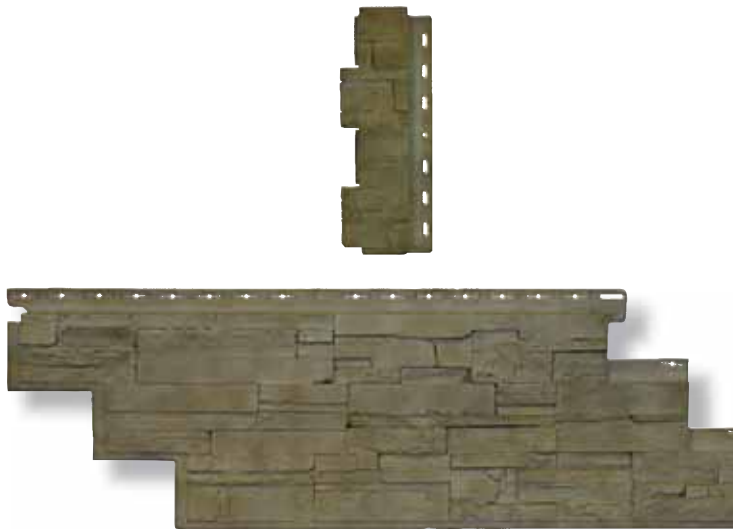

23100540008 DS DRY STACKED STONE PANEL LIMESTONE  
 23120540008 DS DRY STACKED STONE CORNER LIMESTONE

**NOVIK SK STACKED STONE PATTERN**

PANEL SIZE: 45 IN" X 20.25"  
 MATERIAL THICKNESS: 0.090"  
 PIECES PER CARTON: 9  
 SQ. FT. PER CARTON: 1/2 SQUARE  
 APPROX. WEIGHT PER CARTON: 38 LBS.

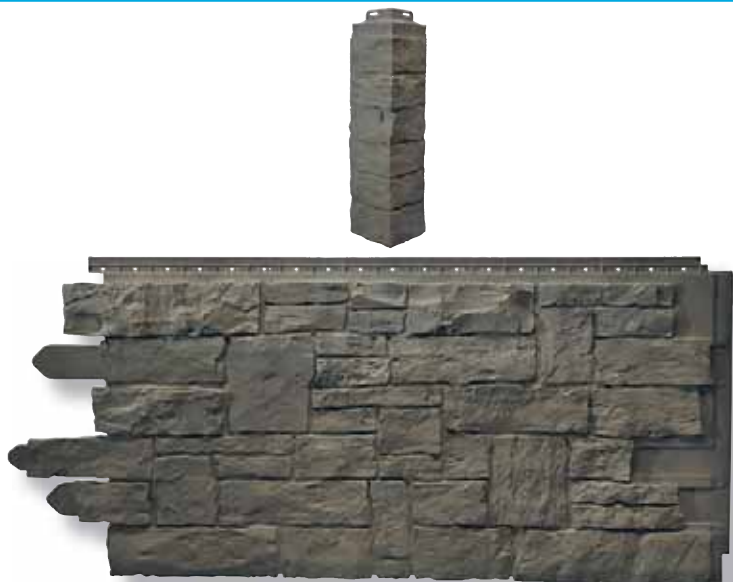

2310014217 SK STACKED STONE PANEL SMOKE GRAY  
 23120145217 SK STACKED STONE CORNER SMOKE GRAY

**NOVIK SK STACKED STONE PATTERN**

45 IN" X 20.25"  
 MATERIAL THICKNESS: 0.090"  
 PIECES PER CARTON: 9  
 SQ. FT. PER CARTON: 1/2 SQUARE  
 APPROX. WEIGHT PER CARTON: 38 LBS.

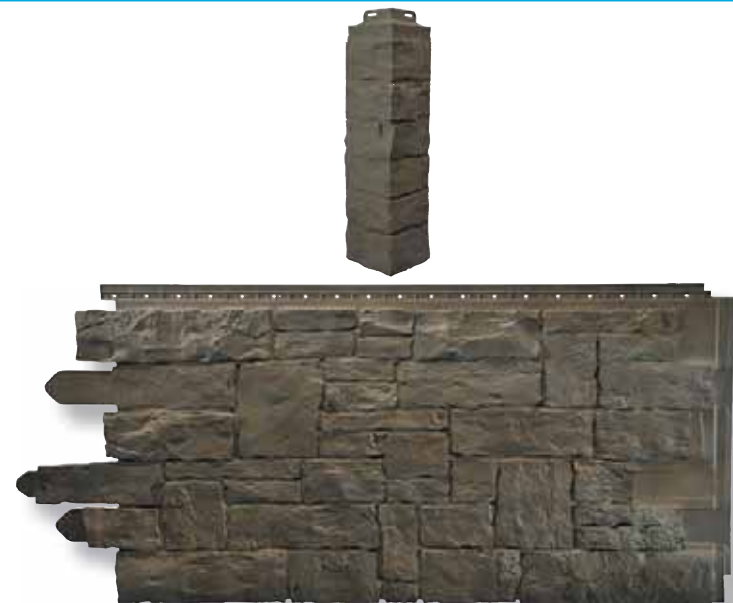

2310014218 SK STACKED STONE PANEL MOKA  
 23120145218 SK STACKED STONE CORNER MOKA

## AVAILABLE IN NORTH EAST UNITED STATES



### **RAPID WALL** FOUNDATION SYSTEM FEATURES

- FULL 2" THICK EPS FOAM BACKED PANEL
- 20-YEAR INSECT WARRANTY
- ADAPTABLE FOR USE IN FROST PROTECTED SHALLOW FOUNDATION SYSTEMS
- EASY INSTALLATION WITHOUT ADDITIONAL FRAMEWORK
- AVAILABLE IN WHITE, GREY AND ALMOND
- 9R+ INSULATION FACTOR
- ENGINEERED TO COMPLY WITH HUD
- WIND LOADING ZONES I, II, III
- NO WARRANTY RESTRICTIONS FOR FOR GROUND CONTACT

Product Availability, Prices and Specifications Subject to Change without Notice. Actual product color may vary slightly from color representation.

# RAPID WALL FOUNDATION SYSTEM PANELS

4' X 12' ARE AVAILABLE IN 3 COLOR CHOICES

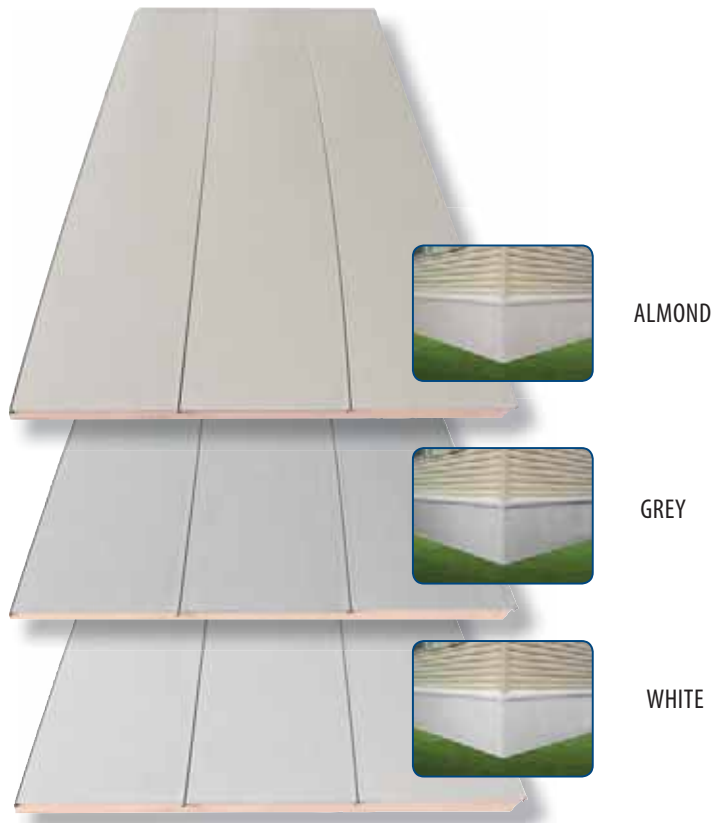

# RAPID WALL FOUNDATION SYSTEM MATCHING ACCESSORIES (SHOWN IN GREY)





**RAPID WALL 4' X 12' PANELS**



- 55060001 4' x 12' PANEL-WHITE
- 55060002 4' x 12' PANEL-GREY
- 55060003 4' x 12' PANEL-ALMOND

**RAPID WALL TRIM FRONT RAILS**



- 55060007 12' TRIM FRONT RAIL-WHITE
- 55060008 12' TRIM FRONT RAIL-GREY
- 55060009 12' TRIM FRONT RAIL-ALMOND

**RAPID WALL TRIM BACK RAILS**



- 55060010 12' TRIM BACK RAIL-WHITE
- 55060011 12' TRIM BACK RAIL-GREY
- 55060012 12' TRIM BACK RAIL-ALMOND

Product Availability, Prices and Specifications Subject to Change without Notice. Actual product color may vary slightly from color representation.

**RAPID WALL TRIM GROUND RAILS**



- 55060013 12' TRIM GROUND RAIL—WHITE
- 55060014 12' TRIM GROUND RAIL—GREY
- 55060015 12' TRIM GROUND RAIL—ALMOND

**RAPID WALL TRIM KITS WITH HARDWARE**

KIT INCLUDES FRONT RAIL, BACK RAIL, AND GROUND RAIL TRIMS PLUS HARDWARE  
16 PIECES 12' EACH 192 FEET TOTAL PER KIT



- 55060004 12' TRIM KITS WITH HARDWARE—WHITE
- 55060005 12' TRIM KITS WITH HARDWARE—GREY
- 55060006 12' TRIM KITS WITH HARDWARE—ALMOND

**RAPID WALL UNDER MOUNT KITS**

KIT INCLUDES FRONT RAIL, BACK RAIL, UNDER MOUNT, CORNER KIT  
AND GROUND RAIL TRIMS PLUS HARDWARE  
16 PIECES 12' EACH 192 FEET TOTAL PER KIT



- 55060019 RAPID WALL-UNDERMNT TRIM KIT-ALMOND
- 55060020 RAPID WALL-UNDERMNT TRIM KIT-GREY
- 55060021 RAPID WALL-UNDERMNT TRIM KIT-WHITE

# Harbour Crest



Premium Vinyl Siding <sup>TM</sup>

- Never needs painting
- Lifetime limited warranty
- Variety of attractive color
- Secure, positive locking system
- Deep embossed wood grain surface
- Resist dents, hail damage, scratches and fading
- Impervious to wood-boring insects, fungus and mildew



20 Colors · 6 Profiles  
Matching Accessories

# Premium Vinyl Siding



**D4**



**DL4**



**DL4.5**



**D5**

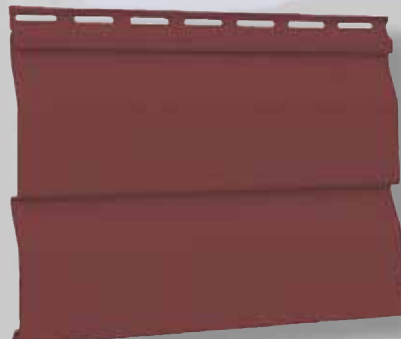

**DL5**



**T3.3**



**Premium Vinyl Siding Accessories**  
Delivering Long Lasting  
Beauty and Performance

- Lifetime limited warranty
- Secure, positive locking system
- Resist dents, hail damage, scratches and fading
- Never needs painting
- Impervious to wood-boring insects, fungus and mildew
- Variety of attractive colors
- Deep embossed wood grain surface



\* Premium Colors made with Armor Coat™ UVA    ^ Elite Colors made with Armor Coat™ Plus    \*\* Legacy Colors made with Armor Coat™ Advanced



**HARBOUR CREST™**

**4" DUTCHLAP**

WOODGRAIN FINISH

DUTCHLAP 4"

.040 GAUGE

LENGTH 12' 6"

24 PANELS/CARTON

2 SQ./CARTON

CARTON WEIGHT: 87.33 LBS

WHITE BIRCH.....	02	HARBOR STONE*.....	44
NEW LINEN.....	13	BASKET BEIGE*.....	46
WARM SANDALWOOD.....	17	SEAGRASS^.....	79
SUNNY MAIZE.....	22	MEADOW*.....	82
SOFT WILLOW*.....	41	NUTMEG ^.....	86
PEBBLE CLAY*.....	43		



SHOWN IN SUNNY MAIZE  
20DL422



20DL4 \_\_\_

## Exterior Products and Accessories

### HARBOUR CREST™

#### 4.5" DUTCHLAP

WOODGRAIN FINISH

DUTCHLAP 4.5"

.040 GAUGE

LENGTH 12'-0"

22 PANELS/CARTON

2 SQ./CARTON

CARTON WEIGHT: 83.99 LBS.

WHITE BIRCH.....	02	BASKET BEIGE*.....	46
CLASSIC SAND.....	11	SLATE BLUE*.....	47
NEW LINEN.....	13	GRAPHITE GREY*.....	49
WARM SANDALWOOD.....	17	JAVA^.....	52
SUNNY MAIZE.....	22	ARTISAN CLAY*.....	61
SUMMER WHEAT.....	26	SEAGRASS^.....	79
SOFT WILLOW*.....	41	CANYON BROWN**.....	81
PEBBLE CLAY*.....	43	MEADOW*.....	82
HARBOR STONE.....	44	NUTMEG^.....	86
OAK MOSS*.....	45	HERITAGE RED**.....	87



SHOWN IN WARM SANDALWOOD  
20DL4517



20DL45 \_\_\_

### HARBOUR CREST™

#### DOUBLE 4"

WOODGRAIN FINISH

DUOUBLE 4

.040 GAUGE

LENGTH 12' 6"

24 PANELS/CARTON

2 SQ./CARTON

CARTON WEIGHT: 87.08 LBS.

WHITE BIRCH.....	02	BASKET BEIGE*.....	46
CLASSIC SAND.....	11	SLATE BLUE*.....	47
NEW LINEN.....	13	GRAPHITE GREY*.....	49
WARM SANDALWOOD.....	17	JAVA^.....	52
SUNNY MAIZE.....	22	ARTISAN CLAY*.....	61
SUMMER WHEAT.....	26	SEAGRASS^.....	79
SOFT WILLOW*.....	41	CANYON BROWN**.....	81
PEBBLE CLAY*.....	43	MEADOW*.....	82
HARBOR STONE.....	44	NUTMEG^.....	86
OAK MOSS*.....	45	HERITAGE RED**.....	87



SHOWN IN SOFT WILLOW  
20D441



20D4 \_\_\_

## Exterior Products and Accessories

### HARBOUR CREST™

#### 5" DUTCHLAP

WOODGRAIN FINISH

DUTCHLAP 5

.040 GAUGE

LENGTH 12'

20 PANELS/CARTON

2 SQ./CARTON

CARTON WEIGHT: 83.30LBS.

WHITE BIRCH .....	02
CLASSIC SAND .....	11
NEW LINEN .....	13
WARM SANDALWOOD .....	17
SUNNY MAIZE .....	22
SUMMER WHEAT .....	26
SOFT WILLOW* .....	41
PEBBLE CLAY* .....	43
HARBOR STONE .....	44
OAK MOSS* .....	45

BASKET BEIGE* .....	46
SLATE BLUE* .....	47
GRAPHITE GREY* .....	49
JAVA^ .....	52
ARTISAN CLAY* .....	61
SEAGRASS^ .....	79
CANYON BROWN** .....	81
MEADOW* .....	82
NUTMEG^ .....	86
HERITAGE RED** .....	87



SHOWN IN HERITAGE RED  
20DL587



20DL5 \_\_\_\_

### HARBOUR CREST™

#### DOUBLE 5"

WOODGRAIN FINISH

DUOUBLE 5

.040 GAUGE

LENGTH 12'

20 PANELS/CARTON

2 SQ./CARTON

CARTON WEIGHT: 82.87 LBS.

WHITE BIRCH .....	02
NEW LINEN .....	13
WARM SANDALWOOD .....	17
SUNNY MAIZE .....	22
SOFT WILLOW* .....	41
PEBBLE CLAY* .....	43
HARBOR STONE .....	44

BASKET BEIGE* .....	46
SLATE BLUE* .....	47
SEAGRASS^ .....	79
MEADOW* .....	82
NUTMEG^ .....	86



SHOWN IN HARBOR STONE  
20D544



20D5 \_\_\_\_

## Exterior Products and Accessories

### HARBOUR CREST™ TRIPLE 3.3"

WOODGRAIN FINISH

TRIPLE 3.3"

.040 GAUGE

LENGTH 12'

20 PANELS/CARTON

2 SQ./CARTON

CARTON WEIGHT: 83.98 LBS.

WHITE BIRCH .....	02	BASKET BEIGE* .....	46
NEW LINEN .....	13	HARBOR STONE* .....	44
WARM SANDALWOOD .....	17	SEAGRASS ^ .....	79
SUNNY MAIZE .....	22	MEADOW* .....	82
SOFT WILLOW* .....	41	NUTMEG ^ .....	86
PEBBLE CLAY* .....	43		



SHOWN IN NUTMEG  
20T33386



20T333 \_\_\_\_

### 5/8" J-CHANNEL

1" FACE MATTE FINISH

5/8" J-CHANNEL

LENGTH 12' 6"

40 PCS./CARTON

500 LINEAR FT.

CARTON WEIGHT: 47.21 LBS.

WHITE BIRCH .....	02	CONCORD GREEN .....	48
CLASSIC SAND .....	11	GRAPHITE GREY .....	49
ALMOND .....	12	TOPAZ .....	51
NEW LINEN .....	13	JAVA .....	52
WARM SANDALWOOD .....	17	ARTISAN CLAY .....	61
SUNNY MAIZE .....	22	SEAGRASS .....	79
COASTAL SKY .....	23	TWILIGHT .....	80
PROVIDENCE YELLOW .....	24	CANYON BROWN .....	81
SUNSET PEACH .....	25	MEADOW .....	82
SUMMER WHEAT .....	26	KEYSTONE .....	85
SOFT WILLOW .....	41	NUTMEG .....	86
PEBBLE CLAY .....	43	HERITAGE RED .....	87
HARBOR STONE .....	44	COUNTRYSIDE GREEN .....	88
OAK MOSS .....	45	HAMPTON BLUE .....	89
BASKET BEIGE .....	46	GREY FLANNEL .....	90
SLATE BLUE .....	47		



SHOWN IN WHITE BIRCH  
39AC38802

39AC388 \_\_\_\_



## Exterior Products and Accessories

### 1/2" J-CHANNEL

1" FACE MATTE FINISH

#### 1/2" J-CHANNEL

LENGTH 12' 6"

40 PCS./CARTON

500 LINEAR FT.

CARTON WEIGHT: 50.81 LBS.

WHITE BIRCH .....	02
CLASSIC SAND .....	11
NEW LINEN .....	13
WARM SANDALWOOD .....	17
SUNNY MAIZE .....	22
SUMMER WHEAT .....	26
SOFT WILLOW .....	41
PEBBLE CLAY*.....	43
HARBOR STONE.....	44
OAK MOSS.....	45
BASKET BEIGE.....	46
SLATE BLUE.....	47
GRAPHITE GREY.....	49

JAVA .....	52
ARTISAN CLAY.....	61
SEAGRASS.....	79
CANYON BROWN .....	81
MEADOW .....	82
NUTMEG.....	86
HERITAGE RED.....	87
AMERICAN CEDAR.....	93
FORREST BROWN.....	95
MUSKET BROWN.....	98



SHOWN IN WHITE BIRCH  
39AC35502

### 39AC355 \_\_\_\_

### 3/4" J-CHANNEL

1" FACE MATTE FINISH

#### 3/4" J-CHANNEL

LENGTH 12' 6"

40 PCS./CARTON

500 LINEAR FT.

CARTON WEIGHT: 52.36 LBS.

WHITE BIRCH .....	02
CLASSIC SAND .....	11
WARM SANDALWOOD .....	17
SUNNY MAIZE .....	22
SUMMER WHEAT .....	26
SOFT WILLOW*.....	41
PEBBLE CLAY*.....	43
HARBOR STONE.....	44
OAK MOSS.....	45
BASKET BEIGE.....	46
SLATE BLUE.....	47
GRAPHITE GREY .....	49
TOPAZ .....	51
JAVA.....	52

ARTISAN CLAY.....	61
SEAGRASS.....	79
TWILIGHT .....	80
CANYON BROWN .....	81
MEADOW .....	82
KEYSTONE.....	85
NUTMEG.....	86
HERITAGE RED.....	87
COUNTRYSIDE GREEN .....	88
HAMPTON BLUE.....	89
GREY FLANNEL .....	90
AMERICAN CEDAR.....	93
FORREST BROWN.....	95



SHOWN IN WHITE BIRCH  
39AC56602

### 39AC566 \_\_\_\_

### 3/8" J-CHANNEL

1" FACE MATTE FINISH

#### 3/8" J-CHANNEL

LENGTH 12' 6"

40 PCS./CARTON

500 LINEAR FT.

CARTON WEIGHT: 46.09 LBS.

WHITE BIRCH .....	02
CLASSIC SAND .....	11
PEBBLE CLAY*.....	43

USE WITH PORCH CEILING PANEL



SHOWN IN WHITE BIRCH  
39AC33302

### 39AC333 \_\_\_\_

## Exterior Products and Accessories

### 4" OUTSIDE CORNER

¾" RECEIVER BRUSHED FINISH

#### 4" OUTSIDE CORNER POST

LENGTH 10'

10 PCS./CARTON

100 LINEAR FT.

CARTON WEIGHT: 42.59 LBS.

WHITE BIRCH .....	02
CLASSIC SAND .....	11
WARM SANDALWOOD .....	17
SUNNY MAIZE .....	22
SOFT WILLOW* .....	41
PEBBLE CLAY* .....	43

HARBOR STONE .....	44
BASKET BEIGE .....	46
GRAPHITE GREY .....	49
ARTISAN CLAY .....	61
NUTMEG .....	86

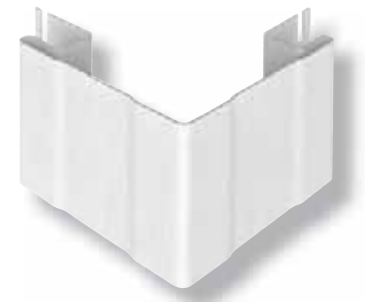

SHOWN IN WHITE BIRCH  
39AD40002

39AD400 \_\_\_

### 4" OUTSIDE CORNER

¾" RECEIVER BRUSHED FINISH

#### 4" OUTSIDE CORNER POST

LENGTH 12'

10 PCS./CARTON

120 LINEAR FT.

CARTON WEIGHT: 53.09 LBS.

WHITE BIRCH .....	02
CLASSIC SAND .....	11
NEW LINEN .....	13
WARM SANDALWOOD .....	17
SUNNY MAIZE .....	22
SUMMER WHEAT .....	26
SOFT WILLOW* .....	41
PEBBLE CLAY* .....	43
HARBOR STONE .....	44
BASKET BEIGE .....	46

SLATE BLUE .....	47
JAVA .....	52
ARTISAN CLAY .....	61
SEAGRASS .....	79
CANYON BROWN .....	81
MEADOW .....	82
NUTMEG .....	86
HERITAGE RED .....	87

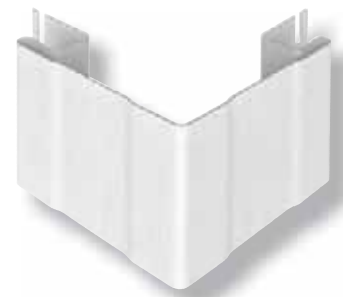

SHOWN IN WHITE BIRCH  
39AD41202

39AD412 \_\_\_

### 3" OUTSIDE CORNER POST

BRUSHED CEDAR WOODGRAIN FINISH

#### 3" OUTSIDE CORNER POST

LENGTH 10'

10 PCS./CARTON

100 LINEAR FT.

CARTON WEIGHT: 34.81 LBS.

WHITE BIRCH .....	02
CLASSIC SAND .....	11
NEW LINEN .....	13
WARM SANDALWOOD .....	17
SUNNY MAIZE .....	22
SUMMER WHEAT .....	26
SOFT WILLOW* .....	41
PEBBLE CLAY* .....	43
HARBOR STONE .....	44
OAK MOSS* .....	45

BASKET BEIGE* .....	46
SLATE BLUE* .....	47
GRAPHITE GREY* .....	49
JAVA^ .....	52
ARTISAN CLAY* .....	61
SEAGRASS^ .....	79
CANYON BROWN** .....	81
MEADOW* .....	82
NUTMEG^ .....	86
HERITAGE RED** .....	87

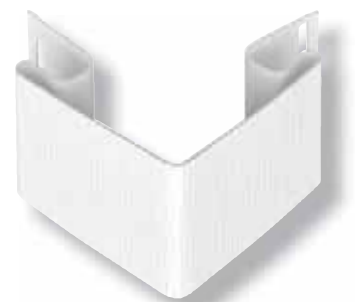

SHOWN IN WHITE BIRCH  
39AC30002

39AC300 \_\_\_

## Exterior Products and Accessories

### 3" BAY CORNER

BRUSHED FINISH

3" BAY CORNER

LENGTH 10'

10 PCS./CARTON

100 LINEAR FT.

CARTON WEIGHT: 34.81 LBS.

WHITE BIRCH .....02

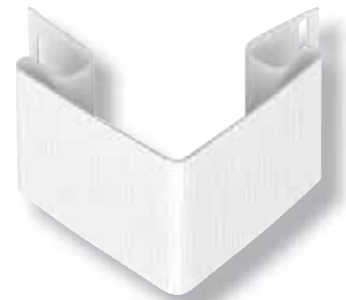

SHOWN IN WHITE BIRCH  
39BC30002

39BC30002

### INSIDE CORNER POST

¾" RECEIVER ¾" FACE

MATTE FINISH

INSIDE CORNER POST

LENGTH 10'

10 PCS./CARTON

100 LINEAR FT.

CARTON WEIGHT: 21.20 LBS.

WHITE BIRCH .....02

CLASSIC SAND ..... 11

ALMOND ..... 12

NEW LINEN ..... 13

WARM SANDALWOOD ..... 17

SUNNY MAIZE ..... 22

SUMMER WHEAT ..... 26

SOFT WILLOW\* ..... 41

PEBBLE CLAY\* ..... 43

HARBOR STONE ..... 44

OAK MOSS ..... 45

BASKET BEIGE ..... 46

SLATE BLUE ..... 47

GRAPHITE GREY ..... 49

JAVA ..... 52

ARTISAN CLAY ..... 61

SEAGRASS ..... 79

CANYON BROWN ..... 81

MEADOW ..... 82

NUTMEG ..... 86

HERITAGE RED ..... 87

AMERICAN CEDAR ..... 93

FORREST BROWN ..... 95

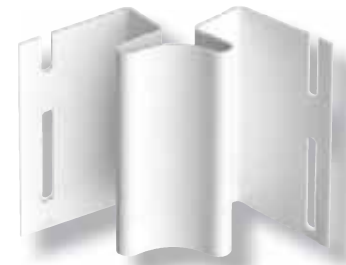

SHOWN IN WHITE BIRCH  
39AC32502

39AC325 \_\_\_\_

### FINISH TRIM ¾" FACE

MATTE FINISH

FINISH TRIM ¾" FACE

LENGTH 12' 6"

40 PCS./CARTON

500 LINEAR FT.

CARTON WEIGHT: 40.72 LBS.

WHITE BIRCH .....02

CLASSIC SAND ..... 11

NEW LINEN ..... 13

WARM SANDALWOOD ..... 17

SUNNY MAIZE ..... 22

SUMMER WHEAT ..... 26

SOFT WILLOW\* ..... 41

PEBBLE CLAY\* ..... 43

HARBOR STONE ..... 44

OAK MOSS ..... 45

BASKET BEIGE ..... 46

SLATE BLUE ..... 47

GRAPHITE GREY ..... 49

JAVA ..... 52

ARTISAN CLAY ..... 61

SEAGRASS ..... 79

CANYON BROWN ..... 81

MEADOW ..... 82

NUTMEG ..... 86

HERITAGE RED ..... 87

AMERICAN CEDAR ..... 93

FORREST BROWN ..... 95



SHOWN IN WHITE BIRCH  
39AC32202

39AC322 \_\_\_\_

## Exterior Products and Accessories

### FRIEZE RUNNER

#### "F"-CHANNEL

MATTE FINISH  
USE WITH SOFFIT

FINISH TRIM ¾" FACE

LENGTH 12' 6"

20 PCS./CARTON

250 LINEAR FT.

CARTON WEIGHT: 23.22 LBS.

WHITE BIRCH .....	02
CLASSIC SAND .....	11
NEW LINEN .....	13
WARM SANDALWOOD .....	17
SUNNY MAIZE .....	22
SUMMER WHEAT .....	26
SOFT WILLOW .....	41
PEBBLE CLAY.....	43
HARBOR STONE.....	44
OAK MOSS.....	45
BASKET BEIGE.....	46
SLATE BLUE.....	47
GRAPHITE GREY .....	49

TOPAZ .....	51
JAVA.....	52
ARTISAN CLAY.....	61
SEAGRASS.....	79
TWILIGHT .....	80
CANYON BROWN .....	81
MEADOW .....	82
KEYSTONE .....	85
NUTMEG.....	86
HERITAGE RED.....	87
COUNTRYSIDE GREEN .....	88
HAMPTON BLUE.....	89
GREY FLANNEL .....	90
MUSKET BROWN.....	98



SHOWN IN WHITE BIRCH  
39AC34402

39AC344 \_\_\_\_

### ¾" T-CHANNEL

1" FACE MATTE FINISH  
USE WITH PORCH CEILING PANELS

¾" T-CHANNEL

LENGTH 12' 6"

20 PCS./CARTON

250 LINEAR FT.

CARTON WEIGHT: 45.73 LBS

WHITE BIRCH .....



39T3802

### ½" T-CHANNEL

MATTE FINISH  
USE WITH SOFFIT

½" T-CHANNEL

LENGTH 12' 6"

20 PCS./CARTON

250 LINEAR FT.

CARTON WEIGHT: 28.34 LBS

WHITE BIRCH .....



39T1202

**5/8" T-CHANNEL**

1" FACE MATTE FINISH

5/8" T-CHANNEL

LENGTH 12' 6"

20 PCS./CARTON

250 LINEAR FT.

CARTON WEIGHT: 51.00 LBS

WHITE BIRCH ..... 02



39AC37702

**FLEX "J" 3/4" OPENING**

FLEX "J" 3/4" OPENING

LENGTH 12' 6"

WIDTH 6"

12 PCS./CARTON

150 LINEAR FT.

CARTON WEIGHT: 24 LBS.

WHITE BIRCH ..... (W)

BEIGE ..... (B)

TAN ..... (T)

PEWTER ..... (P)

LIGHT GREY..... (LG)

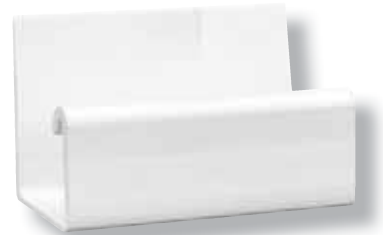

SHOWN IN WHITE BIRCH  
394717W

394717 \_\_\_

**WINDOW/DOOR MOLDING**

1 1/2" FACE MATTE FINISH

WINDOW/DOOR MOLDING

LENGTH 8'

24 PCS./CARTON

192 LINEAR FT.

CARTON WEIGHT: 32.91 LBS.

WHITE BIRCH ..... 02



39WM802

**WINDOW/DOOR MOLDING**

MATTE FINISH

WHITE BIRCH..... 02

WINDOW/DOOR MOLDING

LENGTH 12' 6"

24 PCS./CARTON

300 LINEAR FT.

CARTON WEIGHT: 50.66 LBS.



39WM1202

**CROWN MOLDING—FRONT**

3" FACE MATTE FINISH

WHITE BIRCH..... 02

CROWN MOLDING—FRONT

LENGTH 12' 6"

24 PCS./CARTON

300 LINEAR FT.

CARTON WEIGHT: 35.48 LBS.



39CMFT02

**CROWN MOLDING—FRONT "F"**

3" FACE 5/8" RECEIVER MATTE FINISH

WHITE BIRCH..... 02

CROWN MOLDING—FRONT "F"

LENGTH 12' 6"

24 PCS./CARTON

300 LINEAR FT.

CARTON WEIGHT: 47.35 LBS



39CM02

**SOFFIT CROWN MOLDING—BACK "F"** WHITE BIRCH.....02

MATTE FINISH

SOFFIT MOLDING—BACK "F"  
LENGTH 12' 6"  
20 PCS./CARTON  
250 LINEAR FT.  
CARTON WEIGHT: 34.19 LBS

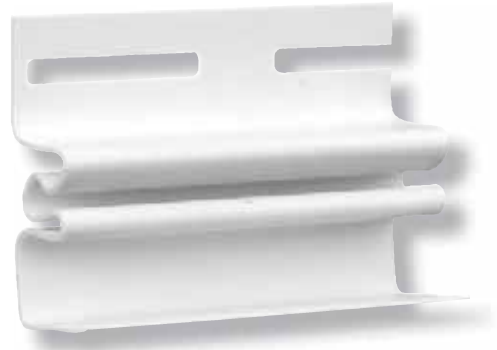

39CMBF02

---

**CROWN MOLDING—RETAINER** WHITE BIRCH.....(W)

MATTE FINISH

CROWN MOLDING—RETAINER  
LENGTH 12' 6"  
20 PCS./CARTON  
250 LINEAR FT.  
CARTON WEIGHT: 24.84 LBS



39CMB02

---

**ALUMINUM STARTER STRIP**

ALUMINUM STARTER STRIP  
LENGTH 10'  
WIDTH 2 1/2"  
50 PCS./CARTON  
500 LINEAR FT.  
CARTON WEIGHT: 30 LBS



39STR

**VINYL STARTER STRIP**

VINYL STARTER STRIP  
LENGTH 12' 6"  
WIDTH 2 1/2"  
40 PCS./CARTON  
500 LINEAR FT.  
CARTON WEIGHT: 53.85 LBS



39VSTR

**WIDE J-CASING**

2 1/2" FACE 3/4" RECEIVER MATTE FINISH

WHITE BIRCH ..... 02

WIDE J-CASING  
LENGTH 12' 6"  
24 PCS./CARTON  
300 LINEAR FT.  
CARTON WEIGHT: 52.20 LBS.



39AC31102

**TRANSITION MOLDING**

2 1/4" FACE 3/4" RECEIVER MATTE FINISH

WHITE BIRCH ..... 02

TRANSITION MOLDING—FRONT "F"  
LENGTH 12' 6"  
15 PCS./CARTON  
187 1/2' LINEAR FT.  
CARTON WEIGHT: 44.66 LBS



39AC39902



## Exterior Products and Accessories

### 6 1/2" VINYL FASCIA

MATTE FINISH

WHITE BIRCH..... 02

6 1/2" VINYL FASCIA  
LENGTH 10'  
36 PCS./CARTON  
360 LINEAR FT.  
CARTON WEIGHT: 79.84 LBS



39FC61202

---

### 7 3/4" VINYL FASCIA

MATTE FINISH

WHITE BIRCH ..... 02

7 3/4" VINYL FASCIA  
LENGTH 10'  
30 PCS./CARTON  
300 LINEAR FT.  
CARTON WEIGHT: 79.81 LBS



39FC73402

---

### 3 1/2" FACE WINDOW LINEAL

3/4" RECEIVER MATTE FINISH

WHITE BIRCH ..... 02

CLASSIC SAND ..... 11

WARM SANDALWOOD ..... 17

PEBBLE CLAY..... 43

3 1/2" FACE WINDOW LINEAL  
LENGTH 12' 6"  
20 PCS./CARTON  
250 LINEAR FT.  
CARTON WEIGHT: 69.66 LBS



39WW35

Product Availability, Prices and Specifications Subject to Change without Notice. Actual product color may vary slightly from color representation.

**5" FACE WINDOW LINEAL**

¾" RECEIVER MATTE FINISH

5" FACE WINDOW LINEAL

LENGTH 12' 6"

15 PCS./CARTON

187 1/2' LINEAR FT.

CARTON WEIGHT: 61.66 LBS

WHITE BIRCH ..... 02

CLASSIC SAND ..... 11

WARM SANDALWOOD ..... 17

PEBBLE CLAY ..... 43



39WW50

**WINDOW LINEAL FOAM INSERT**

FOR 3 ½" WINDOW LINEAL

WINDOW LINEAL FOAM INSERT

LENGTH 12' 6"

10 PCS./CARTON

125 LINEAR FT.

CARTON WEIGHT: 34.41 LBS



39WW35F

**WINDOW LINEAL FOAM INSERT**

FOR 5" WINDOW LINEAL

WINDOW LINEAL FOAM INSERT

LENGTH 12' 6"

10 PCS./CARTON

125 LINEAR FT.

CARTON WEIGHT: 40.56 LBS



39WW50F

## Exterior Products and Accessories

### 10" VINYL SOFFIT

#### SOLID

MATTE FINISH

10" VINYL SOFFIT  
LENGTH 12'  
20 PANELS/CARTON  
2 SQ./CARTON  
CARTON WEIGHT: 85.49 LBS.

WHITE BIRCH .....	02
CLASSIC SAND .....	11
NEW LINEN .....	13
WARM SANDALWOOD .....	17
SUNNY MAIZE .....	22
SOFT WILLOW* .....	41
PEBBLE CLAY* .....	43
HARBOR STONE.....	44

BASKET BEIGE* .....	46
GRAPHITE GREY* .....	49
ARTISAN CLAY* .....	61
NUTMEG^ .....	86
MUSKET BROWN*~ .....	98

~WARRANTED FOR SOFFIT USE ONLY



SHOWN IN WHITE BIRCH  
32DS10SD02

32DS10SD \_\_\_\_

### 10" VINYL SOFFIT

#### VENTED

MATTE FINISH

10" VINYL SOFFIT VENTED  
LENGTH 12'  
20 PANELS/CARTON  
2 SQ./CARTON  
CARTON WEIGHT: 85.25 LBS.  
SQ. IN. VENT AREA PER LF 3.8

WHITE BIRCH .....	02
CLASSIC SAND .....	11
NEW LINEN .....	13
WARM SANDALWOOD .....	17
SUNNY MAIZE .....	22
SOFT WILLOW* .....	41
PEBBLE CLAY* .....	43
HARBOR STONE.....	44

BASKET BEIGE* .....	46
GRAPHITE GREY* .....	49
ARTISAN CLAY* .....	61
NUTMEG^ .....	86
MUSKET BROWN*~ .....	98

~WARRANTED FOR SOFFIT USE ONLY



SHOWN IN WHITE BIRCH  
32DS10VT02

32DS10VT \_\_\_\_

### 12" VINYL SOFFIT

#### SOLID

MATTE FINISH

12" VINYL SOFFIT-SOLID  
LENGTH 12'  
16 PANELS/CARTON  
192 SQ. FT./CARTON  
CARTON WEIGHT: 80.11 LBS.

WHITE BIRCH .....	02
CLASSIC SAND .....	11
NEW LINEN .....	13
WARM SANDALWOOD .....	17
SUNNY MAIZE .....	22
SUMMER WHEAT .....	26
SOFT WILLOW* .....	41
PEBBLE CLAY* .....	43
HARBOR STONE.....	44
OAK MOSS* .....	45
BASKET BEIGE* .....	46

SLATE BLUE* .....	47
GRAPHITE GREY* .....	49
JAVA^ .....	52
ARTISAN CLAY* .....	61
SEAGRASS^ .....	79
CANYON BROWN** .....	81
MEADOW* .....	82
NUTMEG^ .....	86
HERITAGE RED** .....	87
MUSKET BROWN*~ .....	98

~WARRANTED FOR SOFFIT USE ONLY



SHOWN IN WHITE BIRCH  
32DS12SD02

32DS12SD \_\_\_\_

Product Availability, Prices and Specifications Subject to Change without Notice. Actual product color may vary slightly from color representation.

## Exterior Products and Accessories

### 12" VINYL SOFFIT CENTER VENTED

MATTE FINISH

12" VINYL SOFFIT  
CENTER VENTED  
LENGTH 12'  
192 SQ. FT./CARTON  
16 PANELS PER/CARTON  
CARTON WEIGHT: 81.09 LBS.  
SQ. IN. VENT AREA  
PER L.F.:1.3

WHITE BIRCH .....	02
CLASSIC SAND .....	11
WARM SANDALWOOD .....	17
SUNNY MAIZE .....	22
SOFT WILLOW* .....	41
PEBBLE CLAY* .....	43
HARBOR STONE .....	44
BASKET BEIGE* .....	46
GRAPHITE GREY* .....	49

ARTISAN CLAY* .....	61
NUTMEG^ .....	86
MUSKET BROWN*~ .....	98

~WARRANTED FOR SOFFIT USE ONLY



SHOWN IN WHITE BIRCH  
32DS12CV02

32DS12CV \_\_\_

### 12" VINYL SOFFIT VENTED

MATTE FINISH

12" VINYL SOFFIT-VENTED  
LENGTH 12'  
192 SQ. FT./CARTON  
16 PANELS PER/CARTON  
CARTON WEIGHT: 80.11 LBS.  
SQ. IN. VENT AREA  
PER L.F.:40

WHITE BIRCH .....	02
CLASSIC SAND .....	11
ALMOND .....	12
NEW LINEN .....	13
WARM SANDALWOOD .....	17
SUNNY MAIZE .....	22
SUMMER WHEAT .....	26
SOFT WILLOW* .....	41
PEBBLE CLAY* .....	43
HARBOR STONE .....	44
OAK MOSS* .....	45
BASKET BEIGE* .....	46
SLATE BLUE* .....	47
GRAPHITE GREY* .....	49
TOPAZ^ .....	51

JAVA^ .....	52
ARTISAN CLAY* .....	61
SEAGRASS^ .....	79
TWILIGHT^ .....	80
CANYON BROWN**~ .....	81
MEADOW* .....	82
KEYSTONE^ .....	85
NUTMEG^ .....	86
HERITAGE RED**~ .....	87
COUNTRYSIDE GREEN** .....	88
HAMPTON BLUE**~ .....	89
GREY FLANNEL**~ .....	90
MUSKET BROWN*~ .....	98

~WARRANTED FOR SOFFIT USE ONLY



SHOWN IN WHITE BIRCH  
32DS12VT02

32DS12VT \_\_\_

### T2-6" BEADED-SOLID PORCH CEILING PANEL

MATTE FINISH

T2-6" BEADED-SOLID PORCH CEILING PANEL  
LENGTH 8'  
25 PANELS/CARTON  
1 SQ./CARTON  
CARTON WEIGHT: 57.89 LBS.  
**SOLD AS FULL CARTONS ONLY**

WHITE BIRCH .....

.....02



21SS696SD02

**T2-6" BEADED-VENTED  
PORCH CEILING PANEL**

MATTE FINISH

T2-6" BEADED-VENTED PORCH CEILING PANEL  
LENGTH 8'  
25 PANELS/CARTON  
1 SQ./CARTON  
CARTON WEIGHT: 57.89 LBS  
SQ. IN. VENT AREA PER LF 1.2  
**SOLD AS FULL CARTONS ONLY**

WHITE BIRCH .....02



21SS696VT02

**PVC TRIM COIL 24"**

STRIATED FINISH

PVC TRIM COIL 24"  
.019 GAUGE  
1 ROLL/CARTON  
24" WIDTH X 50' LENGTH  
CARTON WEIGHT: 26.5 LBS.  
50 LINEAR FT.

PEBBLE CLAY .....805  
WARM SANDALWOOD .....809  
WHITE BIRCH .....878  
CLASSIC SAND .....879



SHOWN IN WARM SANDALWOOD  
39S4PVC809S

39S24PVC \_\_\_ \_\_\_ S

**TRIM COIL 24"  
SMOOTH**

PAINTED FINISH

PVC TRIM COIL 24"  
.019 GAUGE  
1 ROLL/CARTON  
24" WIDTH X 50' LENGTH  
CARTON WEIGHT: 24.5 LBS.  
50 LINEAR FT.

CLASSIC SAND .....050  
PEBBLE CLAY .....067  
BLACK/ROYAL BROWN .....200202  
WHITE BIRCH .....280  
MUSKET BROWN .....309  
WARM SANDALWOOD .....509



SHOWN IN ROYAL BROWN  
39S24202S

39S24 \_\_\_ \_\_\_ S

## Exterior Products and Accessories

### TRIM COIL 24"

#### SMOOTH

PAINTED FINISH

#### SMOOTH TRIM COIL 24"

.019 GAUGE

1 ROLL/CARTON

24" WIDTH X 50' LENGTH

CARTON WEIGHT: 26 LBS.

50 LINEAR FT.

WHITE BIRCH .....	02	ARTISAN CLAY.....	61
CLASSIC SAND .....	11	SEAGRASS.....	79
ALMOND .....	12	TWILIGHT .....	80
WARM SANDALWOOD .....	17	CANYON BROWN .....	81
SUNNY MAIZE.....	22	MEADOW .....	82
SUMMER WHEAT .....	26	KEYSTONE.....	85
SOFT WILLOW .....	41	NUTMEG.....	86
PEBBLE CLAY.....	43	HERITAGE RED.....	87
HARBOR STONE.....	44	COUNTRYSIDE GREEN .....	88
OAK MOSS.....	45	HAMPTON BLUE.....	89
BASKET BEIGE.....	46	MUSKET BROWN.....	98
SLATE BLUE.....	47	ROYAL BROWN.....	99
GRAPHITE GREY .....	49	BLACK .....	200
JAVA.....	52		

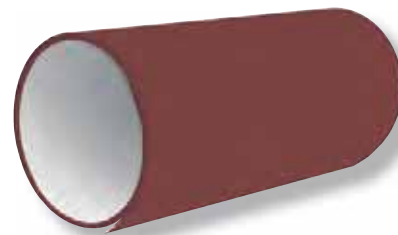

SHOWN IN HERITAGE RED  
39TC87

39TC \_\_\_\_

### PVC TRIM COIL 24"

STRIATED PVC FINISH

#### PVC TRIM COIL 24"

.019 GAUGE

1 ROLL/CARTON

24" WIDTH X 50' LENGTH

CARTON WEIGHT: 28 LBS.

50 LINEAR FT.

WHITE BIRCH .....	02	TOPAZ .....	51
CLASSIC SAND .....	11	JAVA .....	52
ALMOND .....	12	ARTISAN CLAY.....	61
NEW LINEN .....	13	SEAGRASS.....	79
WARM SANDALWOOD .....	17	TWILIGHT .....	80
SUNNY MAIZE.....	22	CANYON BROWN .....	81
PROVIDENCE YELLOW .....	24	MEADOW .....	82
SUMMER WHEAT .....	26	KEYSTONE.....	85
SOFT WILLOW .....	41	NUTMEG.....	86
PEBBLE CLAY.....	43	HERITAGE RED.....	87
HARBOR STONE.....	44	COUNTRYSIDE GREEN .....	88
OAK MOSS.....	45	HAMPTON BLUE.....	89
BASKET BEIGE.....	46	GREY FLANNEL .....	90
SLATE BLUE.....	47	MUSKET BROWN.....	98
CONCORD GREEN .....	48	ROYAL BROWN.....	99
GRAPHITE GREY .....	49		

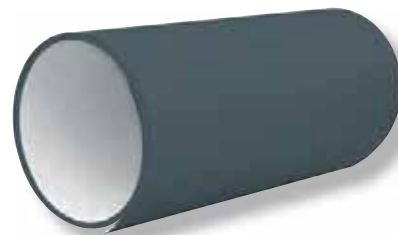

SHOWN IN HAMPTON BLUE  
39TCV89

39TCV \_\_\_\_



**MANUFACTURED HOUSING**

# Universal™ Soffit

*Universal Soffit is made of impact resistant vinyl with a positive locking system for years of satisfaction*

- *Low luster matte finish*
- *Full ventilation configuration*
- *Positive locking system*

---

## 10" VINYL SOLID SOFFIT

BRUSHED FINISH

LENGTH: 12' 0"

20 PCS./CARTON

CARTON WEIGHT: 75.73 LBS.

WHITE BIRCH ..... 02



32US10SD02

---

## 10" VINYL VENTED SOFFIT

BRUSHED FINISH

LENGTH: 12' 0"

20 PCS./CARTON

CARTON WEIGHT: 75.57 LBS.

SQ. IN. VENT AREA PER LF 3.8

WHITE BIRCH ..... 02



32US10VT02

**12" VINYL SOLID SOFFIT**

BRUSHED FINISH

LENGTH: 12' 0"  
 16 PCS./CARTON  
 CARTON WEIGHT: 71.92 LBS.  
 192 SQ. FT./CARTON

WHITE BIRCH ..... 02



32US12SD02

**12" VINYL VENTED SOFFIT**

BRUSHED FINISH

LENGTH: 12' 0"  
 16 PCS./CARTON  
 CARTON WEIGHT: 70.66 LBS.  
 192 SQ. FT./CARTON  
 SQ. IN. VENT AREA PER LF 4.0

WHITE BIRCH ..... 02



32US12VT02

**12" VINYL CENTER VENTED SOFFIT**

BRUSHED FINISH

LENGTH: 12' 0"  
 16 PCS./CARTON  
 CARTON WEIGHT: 70.90 LBS  
 192 SQ. FT./CARTON.  
 SQ. IN. VENT AREA PER LF 1.3

WHITE BIRCH ..... 02



32US12CV02

**12" VINYL SOFFIT/BASKET WEAVE VENTED**

BRUSHED FINISH

LENGTH: 12' 0"  
 16 PCS./CARTON  
 CARTON WEIGHT: 72.13 LBS.  
 192 SQ. FT./CARTON  
 SQ. IN. VENT AREA PER LF 14.7

WHITE BIRCH ..... 02

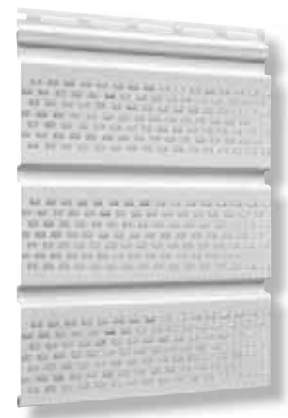

32US12BW02





Perrenia shutters emphasize the beauty of your homes windows.

- Deeply etched, natural woodgrain texture\*
- Raised panel or classic louvered
- Decorative color pallet, plus a paintable option
- Color throughout—will not scratch, peel or fade
- Maintenance-free, high-impact polypropylene—will not crack or dent
- 12" or 14 ¾" shutter widths
- Proudly made in the USA
- Limited Lifetime Warranty



Perrenia Louvered Shutters Shown in Cranberry



Perrenia Raised Panel Shutters Shown in Indigo Blue



## Exterior Products and Accessories

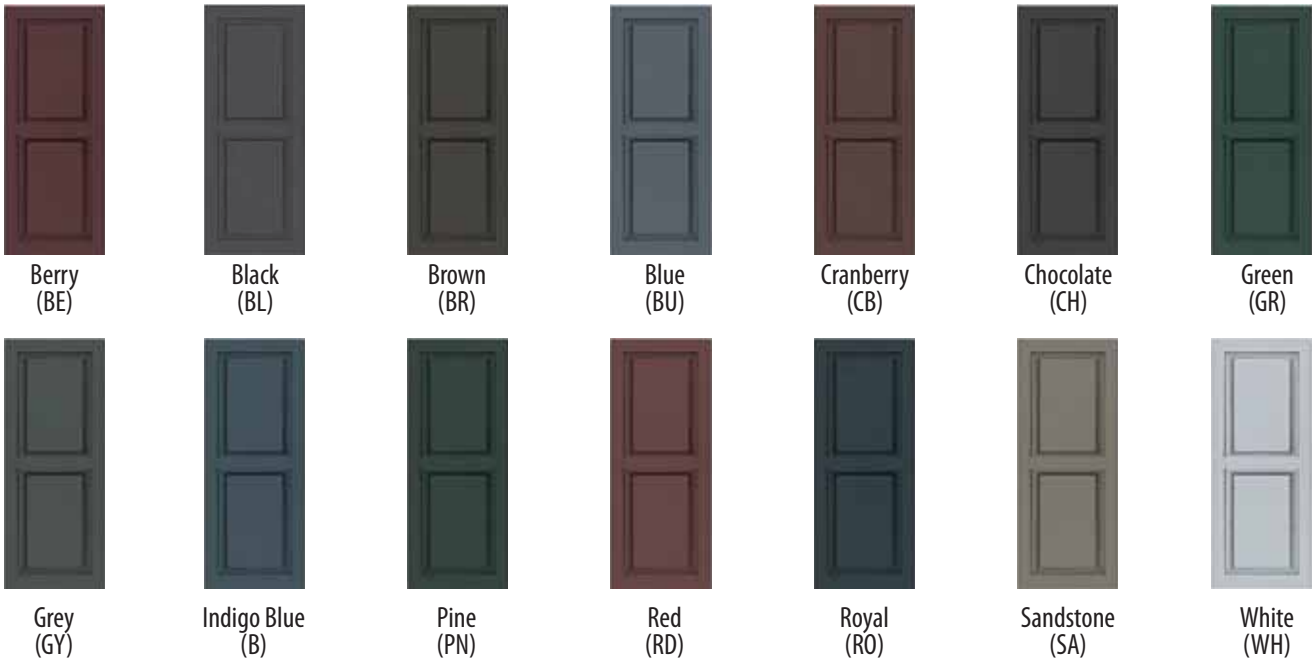

### TRADITIONAL OPEN LOUVER SHUTTER 12"

39VNB1228\_\_OL 12" WIDTH x 28" LENGTH  
 39VNB1231\_\_OL 12" WIDTH x 31" LENGTH  
 39VNB1235\_\_OL 12" WIDTH x 35" LENGTH  
 39VNB1239\_\_OL 12" WIDTH x 39" LENGTH  
 39VNB1243\_\_OL 12" WIDTH x 43" LENGTH  
 39VNB1247\_\_OL 12" WIDTH x 47" LENGTH  
 39VNB1251\_\_OL 12" WIDTH x 51" LENGTH  
 39VNB1255\_\_OL 12" WIDTH x 55" LENGTH  
 39VNB1260\_\_OL 12" WIDTH x 60" LENGTH  
 39VNB1264\_\_OL 12" WIDTH x 64" LENGTH  
 39VNB1267\_\_OL 12" WIDTH x 67" LENGTH  
 39VNB1271\_\_OL 12" WIDTH x 71" LENGTH

### COLONIAL RAISED PANEL SHUTTER 12"

39VNB1228\_\_RP 12" WIDTH x 28" LENGTH  
 39VNB1231\_\_RP 12" WIDTH x 31" LENGTH  
 39VNB1235\_\_RP 12" WIDTH x 35" LENGTH  
 39VNB1239\_\_RP 12" WIDTH x 39" LENGTH  
 39VNB1243\_\_RP 12" WIDTH x 43" LENGTH  
 39VNB1247\_\_RP 12" WIDTH x 47" LENGTH  
 39VNB1251\_\_RP 12" WIDTH x 51" LENGTH  
 39VNB1255\_\_RP 12" WIDTH x 55" LENGTH  
 39VNB1260\_\_RP 12" WIDTH x 60" LENGTH  
 39VNB1264\_\_RP 12" WIDTH x 64" LENGTH  
 39VNB1267\_\_RP 12" WIDTH x 67" LENGTH  
 39VNB1271\_\_RP 12" WIDTH x 71" LENGTH

### TRADITIONAL OPEN LOUVER SHUTTER 14"

39VNB1528\_\_OL 14" WIDTH x 28" LENGTH  
 39VNB1531\_\_OL 14" WIDTH x 31" LENGTH  
 39VNB1535\_\_OL 14" WIDTH x 35" LENGTH  
 39VNB1539\_\_OL 14" WIDTH x 39" LENGTH  
 39VNB1543\_\_OL 14" WIDTH x 43" LENGTH  
 39VNB1547\_\_OL 14" WIDTH x 47" LENGTH  
 39VNB1551\_\_OL 14" WIDTH x 51" LENGTH  
 39VNB1555\_\_OL 14" WIDTH x 55" LENGTH  
 39VNB1560\_\_OL 14" WIDTH x 60" LENGTH  
 39VNB1564\_\_OL 14" WIDTH x 64" LENGTH  
 39VNB1567\_\_OL 14" WIDTH x 67" LENGTH  
 39VNB1571\_\_OL 14" WIDTH x 71" LENGTH

### COLONIAL RAISED PANEL SHUTTER 14 3/4"

39VNB1528\_\_RP 14 3/4" WIDTH x 28" LENGTH  
 39VNB1531\_\_RP 14 3/4" WIDTH x 31" LENGTH  
 39VNB1535\_\_RP 14 3/4" WIDTH x 35" LENGTH  
 39VNB1539\_\_RP 14 3/4" WIDTH x 39" LENGTH  
 39VNB1543\_\_RP 14 3/4" WIDTH x 43" LENGTH  
 39VNB1547\_\_RP 14 3/4" WIDTH x 47" LENGTH  
 39VNB1551\_\_RP 14 3/4" WIDTH x 51" LENGTH  
 39VNB1555\_\_RP 14 3/4" WIDTH x 55" LENGTH  
 39VNB1560\_\_RP 14 3/4" WIDTH x 60" LENGTH  
 39VNB1564\_\_RP 14 3/4" WIDTH x 64" LENGTH  
 39VNB1567\_\_RP 14 3/4" WIDTH x 67" LENGTH  
 39VNB1571\_\_RP 14 3/4" WIDTH x 71" LENGTH



## Perrenia Mounting Blocks Available in 22 Colors

ALMOND .....	009
ARTISAN CLAY.....	129
BASKET BEIGE.....	003
CANYON BROWN .....	200
CLASSIC SAND .....	184
FORREST BROWN.....	066
GRAPHITE GREY.....	201
HARBOR STONE.....	190

HERITAGE RED.....	202
JAVA.....	301
MEADOW .....	037
NEW LINEN .....	185
NUTMEG.....	004
OAK MOSS.....	193
PEBBLE CLAY.....	312
SEAGRASS.....	212

SLATE BLUE .....	210
SUMMER WHEAT .....	188
SUNNY MAIZE.....	010
SOFT WILLOW .....	192
WARM SANDALWOOD .....	186
WHITE BIRCH.....	183

### EXHAUST VENT KIT

INCLUDES BATHROOM VENT AND 8" PIPE

O.D. 7 1/4" x 7 1/4"  
DEPTH OF RECEIVER 1.0"  
RECEIVER POSITIONS 3/4", 1 1/4"  
4 KITS PER CARTON



39ZE\_\_\_\_

### STANDARD MOUNT

O.D. 7 1/4" x 7 3/4"  
DEPTH OF RECEIVER 1.0"  
RECEIVER POSITIONS 3/4", 1 1/4"  
10 PER CARTON



39Z13\_\_\_\_

### RECESSED SPLIT MOUNT

O.D. 6" x 8 1/2"  
DEPTH OF RECEIVER 1.0"  
RECEIVER POSITIONS 3/4", 1 1/4"  
10 PER CARTON



39Z15\_\_\_\_

### MINI MOUNT

O.D. 7 1/2" x 4 1/2"  
DEPTH OF RECEIVER 3/4"  
RECEIVER POSITIONS 3/4", 1 1/4"  
10 PER CARTON



39Z43\_\_\_\_



ProPride™ gives any home a fresh perspective.

- Our Positive Locking™ makes it easy to install
- Outstanding features—Engineered with roll-over nail hem, color fastness and more, for excellent value in an economical siding choice.
- Easy installation; goes up fast, great curb appeal
- Dutchlap (DL) 4.5 profile
- 10 colors to suit many home styles
- ISO 9000-1 certified quality system—You get consistent quality, reliable performance
- Meets ASTM D3679 industry standard for performance
- Limited Lifetime Warranty



\* Premium Colors made with Armor Coat™ UVA



**4.5" DUTCHLAP**

**PROPRIDE®**  
BRUSHED CEDAR  
WOODGRAIN FINISH

DUTCHLAP 4 ½"  
.038 GAUGE  
LENGTH 12' 1"  
22 PANELS/CARTON  
2 SQ./CARTON  
CARTON WEIGHT: 75.59 LBS

WHITE BIRCH .....	02	PEBBLE CLAY*.....	43
CLASSIC SAND .....	11	HARBOR STONE*.....	44
WARM SANDALWOOD .....	17	SLATE BLUE*.....	47
SUNNY MAIZE .....	22	GRAPHITE GREY*.....	49
SOFT WILLOW*.....	41	ARTISAN CLAY*.....	61



SHOWN IN WHITE BIRCH  
27GB24502

27GB245 \_\_\_

# MANUFACTURED HOUSING WHEEL & AXLE COMPONENTS

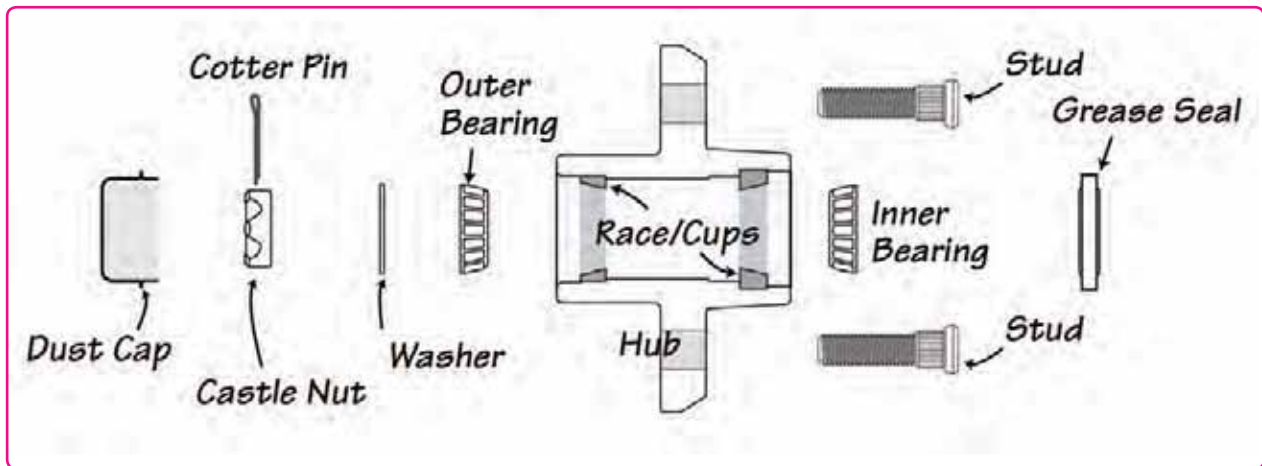
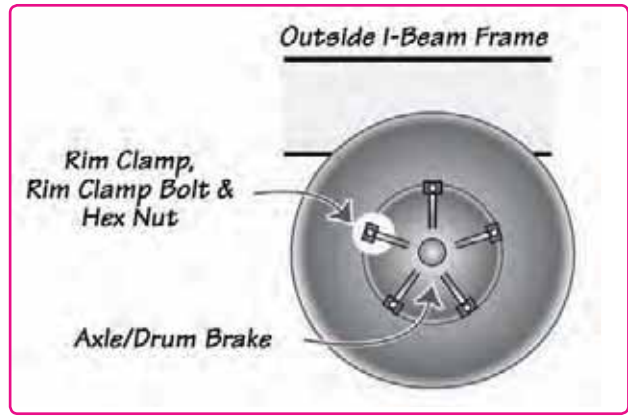
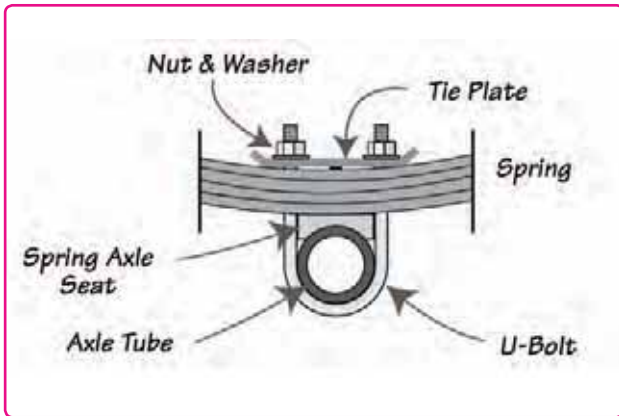
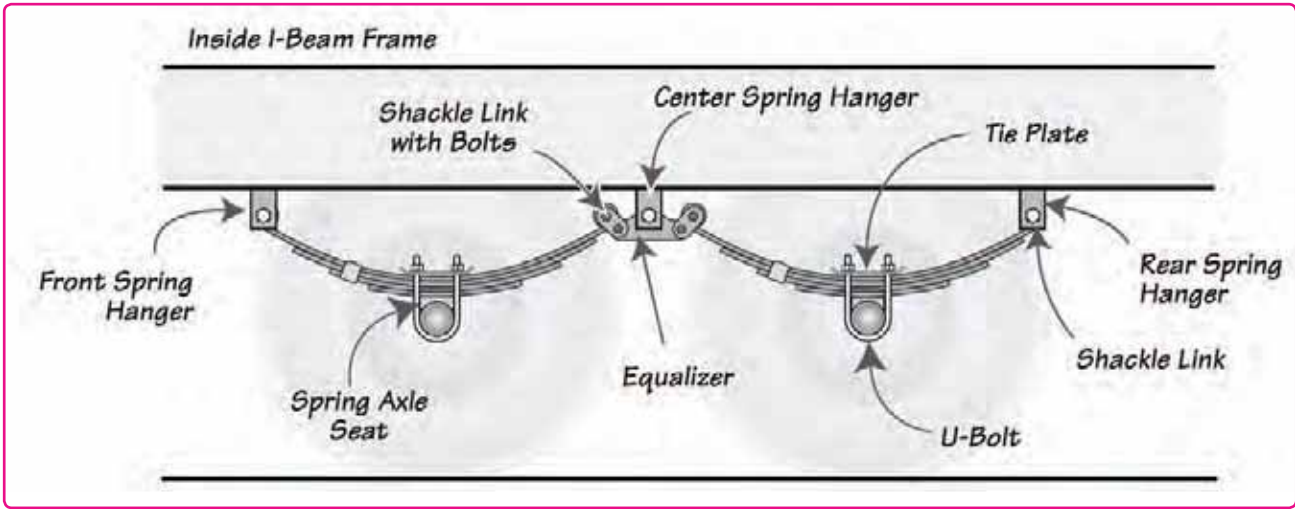

# TRANSPORTATION

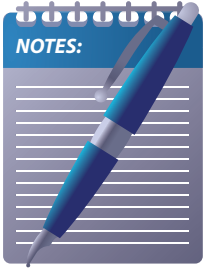

Four horizontal lines for writing, alternating between light blue and light yellow backgrounds.

Main body of the page containing 20 horizontal lines for writing, alternating between light blue and light yellow backgrounds.



## TRANSPORTATION

### SPRING HANGER



60285 3 1/4" HIGH - 1 3/4" WIDE

### SPRING HANGER



60286 1 1/2" HIGH - 1 3/4" WIDE

### STEEL EQUALIZER CAST



601329 3 1/4" HIGH - 6 3/4" WIDE  
OVERALL NO BUSHINGS

### DOUBLE EYE CAST EQUALIZER

BUSHED HOLES



601310 4" HIGH 7 1/4" LONG

### SHACKLE LINK



601811 2" HOLE TO HOLE  
3 3/4" OVERALL

### SHACKLE BOLT PLATED



6073 9/16"-18 THREAD x 3"  
FOR 1 3/4" SPRING

### HEX LOCKNUT



6067 LOCKNUT HEX 9/16" X 18 THREAD  
FOR SHACKLE BOLT

### SPRING TIE PLATE



60121 3" TUBE 1 3/4" SPRING  
FOR 1/2" U-BOLTS

### SPRING SEAT



60342 4" LONG FOR 3" TUBE 1.62" WIDE  
.58" TALL, 4" LONG

**TRANSPORTATION**

**HEX NUT**



FOR U-BOLT

**U-BOLT**



601149 1/2" - 20 THREAD, 7" LONG  
FOR 3" DIA. TUBE

**U-BOLT**



601116 1/2" - 20 THREAD, 6 1/2" LONG  
FOR 3" DIA. TUBE

**BEARING CONE INNER**  
2-7/8" DIAMETER



6025580 BEARING CONE INNER 2 7/8"

**BEARING CONE OUTER**  
2" DIAMETER



606748 BEARING CONE OUTER 2"

**GREASE SEAL**



601041 1.938" x 2.52" x .37" NYLO

**HEAVY DUTY LUG BOLT**  
RIM CLAMP BOLT



60736 RIM CLAMP BOLT 1/2"  
13 THREAD x 1 1/6"

**HEAVY HEX LUG BOLT PLATED**  
RIM CLAMP BOLT



60723 RIM CLAMP BOLT 1/2"  
13 THREAD x 2 1/4"

**RIM CLAMP PLATED**



60152 CLAMP



**TRANSPORTATION**

**GREASE CAP**



60211 2.45" OD 1.34" HIGH W/FLANGE

**SHOCK CORD**

W/LOCKING METAL SNAPS



6051622 18" LENGTH - 25/CTN

**TARP STRAPS**

RUBBER W/ METAL "S" HOOKS



6215 15" LENGTH / RUBBER 25/CTN  
6221 20" LENGTH / RUBBER 25/CTN  
6231 31" LENGTH / RUBBER 25/CTN

**FLAG ON STAFF**



6052612 18" x 18" FLAG ON 3/4" STAFF  
25/CTN

**NYLON TRICOT  
FLAGS AND CLIP**



6052282 18" x 18", RED 50/CTN  
6052602 18" FLAG ON 1/2" STAFF 25/CTN  
6051320 PLASTIC FLAG CLIPS (25 PER BAG)

**POLY FILM SHEETING**

BLACK BARRIER SHEETING - 6 MIL



PREMIUM QUALITY  
608146 14' x 100' BLK POLY FILM  
608166 16' x 100' BLK POLY FILM  
608206 20' x 100' BLK POLY FILM

ECONOMY QUALITY  
60100002 14' x 100' BLK POLY FILM  
60100003 16' x 100' BLK POLY FILM  
60100004 20' x 100' BLK POLY FILM

**POLY FILM SHEETING**

WHITE CLOSE UP FILM - 4MIL



PREMIUM QUALITY  
608120 14' X 300' CLOSE UP FILM U.V  
POLY FILM WHITE- 4 MIL

ECONOMY QUALITY  
60100001 14' X 300' CLOSE UP FILM U.V  
POLY FILM WHITE- 4 MIL

**SIGNS - BLACK ON YELLOW**



60253235 SIGN-OVERSIZE LOAD-MESH 20"x 7'  
6050421 SIGN-METAL 2 SIDE-OVERSIZE  
LOAD/WIDE LOAD

**SIGNS - BLACK ON YELLOW**

W/FIXED PANELS NUMBERING 10, 12, 14, 16



PANELS ARE ATTACHED TO THE TOP OF THE  
FLAG AND CAN BE FLIPPED OVER THE BACK  
TO INDICATE THE WIDTH OF THE LOAD

**10 12 14 16**

6053244 SIGN-NYLON-MULTI SIZE  
OVERSIZE LOAD/WIDE LOAD

# TRANSPORTATION

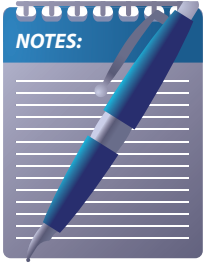

Four horizontal lines for writing, alternating between white and light blue backgrounds.

Main body of the page containing 20 horizontal lines for writing, alternating between white and light blue backgrounds.



**Offering a full range of anchoring and tie down systems including:**

BE SURE TO CONSULT LOCAL REGULATORS FOR CODE QUESTIONS AND THE MANUFACTURERS INSTALLATION MANUAL FOR PROPER MATERIALS.

- Anchors
- Pan Systems
- Jacks and Piers
- Boards and Wedges
- Pier Pads
- Pipe Straps and Buckles
- Poly Film
- Tools
- Metal Flashing



**PAINTED TWIN DISK ANCHORS**

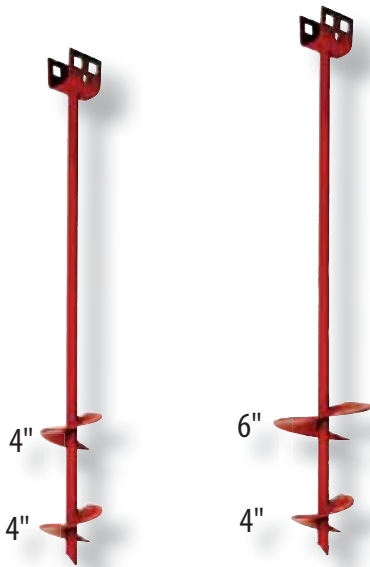

486012M 30" x 3/4"  
W/TWIN 4 HELIX 8/BUNDLE  
48364634M 36" x 3/4"  
W/1-4" & 1-6" HELIX

**GALVANIZED TWIN DISK ANCHORS**

CODE APPROVED IN MANY AREAS GALVANIZED



481271G 30" X 3/4" SHAFT  
W/TWIN 4" HELIX  
GALVANIZED 8/BUNDLE  
481346G 36" x 3/4" SHAFT  
W/1-4", 1-6" HELIX  
GALVNIZED

**GALVANIZED ANCHORS SINGLE DISK**

MEETS FL & OTHER STATE CODES FOR CERTAIN APPLICATIONS/GALVANIZED



486050G 24" LONG x 5/8" ROD  
W/6"HELIX  
486013G 48" LONG x 5/8" ROD  
W/6"HELIX 4/BUNDLE  
486030G 48" LONG x 3/4" ROD  
W/6"HELIX 4/BUNDLE

**SET-UP**

**EZ ANCHOR® MM BELLED ANCHORS**



- 481592 30" x 3/4" SHAFT W/2"-4" HELIX PAINTED
- 481593 36" x 3/4" SHAFT W/6"-4" HELIX PAINTED

**DEEP-SET TIE DOWN ANCHORS**



- 4859092 ANCHOR DEEP SET 36" X 3/4" PAINTED 4/BUNDLE \* PANAMA CITY FLA. -ONLY

**CROSS "X" DRIVE ANCHORS**

PAINTED / GALVANIZED  
USED IN SOLID ROCK



- 481360 "X" CROSS DRIVE HEAD ONLY 16/CARTON
- 481380 "X" CROSS DRIVE RODS ONLY 30" x 3/4" 8/BUNDLE

**CONCRETE ANCHORS**

FOR USE IN WET OR CURED CONCRETE

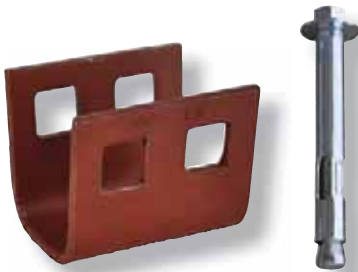

- 486001 DOUBLE TENSION HEAD PAINTED 48/BUNDLE
- 482388 DOUBLE TENSION HEAD GALVANIZED 48/BUNDLE
- 481061 BOLT ANCHOR CONCRETE 5/8" x 3" 120/BOX

**CONCRETE ANCHORS**

FOR USE IN WET OR CURED CONCRETE



- 481445 "J" HOOK SWIVEL HEAD PAINTED 24/CARTON
- 481445G "J" HOOK SWIVEL HEAD GALVANIZED 24/CARTON
- 483636 "J" HOOK NON SWIVEL PAINTED

**CORAL MOBILE HOME SPECIALTY ANCHOR**

LIMITED CODE APPROVAL



- 481278 36" x 5/8" W/3 BARBS 8/BUNDLE 200/SKID

## SET-UP

### FRAME HOOK W/STRAPS



G120 - 8 PER BUNDLE

- 48102106 6' STRAP 1200 / SKID
- 48102107 7' STRAP 1200 / SKID
- 48102108 8' STRAP 1200 / SKID
- 48102110 10' STRAP 600 / SKID
- 48102112 12' STRAP 600 / SKID
- 48102114 14' STRAP 600 / SKID
- 48102116 16' STRAP 600 / SKID
- 48102118 18' STRAP 600 / SKID

### DOUBLE SLOT BUCKLE W/STRAPS



G120 - 8 PER BUNDLE

- 48102206 6' STRAP 1200 / SKID
- 48102207 7' STRAP 1200 / SKID
- 48102208 8' STRAP 1200 / SKID
- 48102210 10' STRAP 600 / SKID
- 48102214 14' STRAP 600 / SKID

### SWIVEL STRAP CONNECTOR W/STRAPS

MEETS FLORIDA CODE



G120 - 8 PER BUNDLE

- 48102505 SWIVEL STRAP CON. W/5' STRAP
- 48102506 SWIVEL STRAP CON. W/6' STRAP
- 48102507 SWIVEL STRAP CON. W/7' STRAP
- 48102508 SWIVEL STRAP CON. W/8' STRAP
- 48102512 SWIVEL STRAP CON. W/12' STRAP

### UNIVERSAL QUICK ASSEMBLY W/STRAPS



- 4859206 QUICK ASSEMBLY WITH 6' STRAP
- 4859208 QUICK ASSEMBLY WITH 8' STRAP

### SLOTTED SPLIT BOLT & NUT



- 482010 SLOTTED SPLIT BOLT/NUT

### GALVANIZED STRAPS

G60 & G120



G60 GALVANIZED STANDARDS

- 48102100 1 1/4" x 600' G60
- 48102370 1 1/4" x 37' G60

G120 GALVANIZED STANDARDS (FLORIDA)

- 48102600 1 1/4" x 600' G120
- 48102375 1 1/4" x 37' G120

## SET-UP

### STRAP SEAL



48101014 FOR 1 1/4" STRAP  
1,000/CTN

### FRAME HOOK



48101100 FRAME HOOK ONLY-50/CTN

### DOUBLE SLOT STRAP BUCKLE



48101200 BUCKLE ONLY-50/CTN

### HEAVY DUTY ROOF BRACKET



4859145 GALVANIZED—24/CTN

### MOBILE HOME BLOCKING PIERS

STEEL PIERS WITH 4" ADJUSTABLE HEAD  
(MAXIMUM EXTENSION 2" HUD CODE)



PIER HEAD

- 033001 PIER HEAD W/NUT 40/BOX
- 033008 PIER STEEL 8" RED
- 033010 PIER STEEL 10" RED
- 033012 PIER STEEL 12" RED
- 033014 PIER STEEL 14" RED
- 033016 PIER STEEL 16" RED
- 033018 PIER STEEL 18" RED
- 033020 PIER STEEL 20" RED
- 033022 PIER STEEL 22" RED
- 033024 PIER STEEL 24" RED
- 033026 PIER STEEL 26" RED
- 033028 PIER STEEL 28" RED
- 033030 PIER STEEL 30" RED



MANUFACTURED HOUSING

## SET-UP

### TIE 4-BOLT LONGITUDINAL FRAME

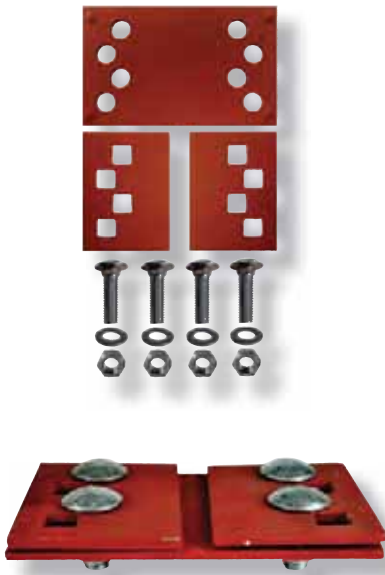

482822 TIE 4-BOLT LONGITUDIAL  
FRAME

### LONGITUDE BEAM CLIP W/ BOLTS AND NUTS



483510 LONGITUDE BEAM CLIP  
W/BOLT & NUT

### CLAMP-GATOR BEAM 8-BOLT



4859011 CLAMP GATOR BEAM 8 BOLT

### ANGLED FRAME BRACKET W/ BOLTS AND NUTS



4859009 ANGLED FRAME BRACKET W/BOLTS  
AND NUTS - 24 PER BOX

### BEAM CLAMPS W/ BOLT AND NUT



4859003 3" BEAM CLAMP  
W/ BOLT AND NUT - 24/BOX  
4859004 4" BEAM CLAMP  
W/ BOLT AND NUT - 24/BOX  
4859005 DOUBLE BEAM CLAMP  
W/ BOLT AND NUT - 24/CTN

### QUIK-SET STABILIZER PLATE



4859291 STABILIZER PLATE  
4 PER BOX; 224 SKID

## SET-UP

### PAINTED STABILIZER PLATE



48233 12" x 11 1/4" x 8GA PLATE

### GALVANIZED STABILIZER PLATE



482202G 17 1/2" STABILIZER PLATE  
GALVANIZED

### PLASTIC STABILIZER PLATE MEETS FLORIDA REGULATIONS



4859293 PLASTIC STABILIZER PLATE

### HYDRAULIC BOTTLE JACKS



6276512 12 TON, LIFT: 6 1/16" - 10 7/16" - 4/CTN  
6276412 12 TON, LIFT: 9 7/16" - 15 5/16" - 4/CTN  
612100 REPAIR KITS  
FOR 12 TON JACK

### HYDRAULIC BOTTLE JACK



6276520 20 TON, LIFT: 10 13/16" - 7 7/16"  
621253 REPAIR KITS  
FOR 20 TON JACK



MANUFACTURED HOUSING



## SET-UP

### STRAP CRIMP TOOL

FOR ANCHOR STRAPS



621125 STRAP CRIMP TOOL  
FOR 1 1/4" STRAP

### POCKET PENETROMETER AND ADAPTER FOOT



62700 POCKET PENETROMETER  
W/ CANVAS CASE  
62701 ADAPTER FOOT

### ANCHOR SPEED WRENCH



6248900 ANCHOR SPEED WRENCH

### ANCHOR DRIVE MACHINE

HEAVY DUTY 17.25 RPM  
1/2 HP DRIVE MACHINE  
120V / 60 CYCLE / 9 AMP  
MOTOR "ON / OFF" SWITCH  
W/ FORWARD & REVERSE  
DRIVE HEAD SOLD SEPARATELY (#482741)



482741 DRIVE HEAD ADAPTER  
4859226 1/2 HP DRIVE MACHINE

### SOIL TEST PROBE

DETERMINES SOIL TYPE FOR PROPER  
ANCHOR SELECTION



4859200 SOIL TEST PROBE  
W/ CARRYING CASE & TORQUE  
WRENCH INSTRUCTION

### PIER PADS



03041616 PIER PAD 16"x16", 15/BDL.  
0359300 PIER PAD 16"x18", 12/BDL.  
0359302 PIER PAD 17"x 25", 5/BDL.  
03041818 PIER PAD 18 1/2"x18 1/2", 15/BDL.  
03042020 PIER PAD 20"x20", 15/BDL.  
032424 PIER PAD 24"x24"

## SET-UP

### BOARDS WEDGES PIERS - BOARDS



03170	BOARD HARDWOOD 1" x 8" x 16" TREATED 10/BDL
03180	BOARD H hardwood 2" x 8" x 16" TREATED 5/BDL
031800	BOARD HARDWOOD 1" x 8" x 16" N/T 10/BDL
0318110	BOARD PINE 1" x 8" x 16" P/T 10/BDL
031825	BOARD PINE 2" x 8" x 16" P/T 5/BDL
031900	BOARD H hardwood 2" x 8" x 16" N/T 5/BDL
03212830	TRVL STICKS 1 1/16" x 5/8" x 8' PLY NT
032905	BOARD HARDWOOD 2" x 8" x 16" N/T
30122	BOARD HARDWOOD 1" x 8" x 16" TREATED 10/BDL
30124	BOARD HARDWOOD 2" x 8" x 16" TREATED 10/BDL

### BOARDS WEDGES PIERS - WEDGES



03101	WEDGE HARDWOOD 3" x 8" x 1" N/T 100/BG
03140	WEDGE HARDWOOD 4" x 6" x 1" TREATED 25/BDL
0315280	WEDGE PINE 8" x 4" x 1" P/T 60/SKID
03154	WEDGE HARDWOOD 4" x 1 1/2" N/T 64/BD
03160	WEDGE HARDWOOD 3" x 9" x 1" N/T 25BDL
031805	WEDGE HARDWOOD 3/4" x 4" x 8" N/T 30/BDL
03020001	WEDGE HARDWOOD 1" x 4" x 12" N/T 25/BDL
03190	WEDGE HARDWOOD 4" x 8" x 1" TREATED 30 BDL
30120	WEDGE HARDWOOD 2" x 4" x 8" P/T 80/BAG
30125	WEDGE HARDWOOD 1" x 4" x 7" N/T 40/BAG

### LAG SCREWS & WASHERS

3/16" HEX HEAD, ZINC & NO ZINC PLATED

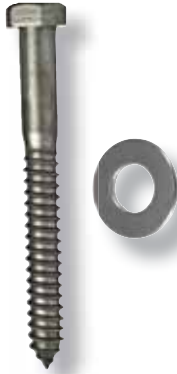

653852	3/8" X 1 1/2" FLAT WASHER ZINC - 50/BAG
653850	3/8" FLAT WASHER ZINC - 50/BOX
653851	3/8" X 5" SCREW ZINC - 300/BOX
6538450	3/8" X 4" SCREW ZINC - 50/BOX
6538550	3/8" X 5" SCREW ZINC - 50/BOX
6538650	3/8" X 6" SCREW ZINC - 50/BOX

### POLY FILM VAPOR BARRIER SHEETING

BLACK SHEETING - 6 MIL



PREMIUM QUALITY

608146	14' x 100' BLACK POLY FILM
608166	16' x 100' BLACK POLY FILM
608206	20' x 100' BLACK POLY FILM

ECONOMY QUALITY

60100002	14' x 100' BLACK POLY FILM
60100003	16' x 100' BLACK POLY FILM
60100004	20' x 100' BLACK POLY FILM

### POLY FILM SHEETING

WHITE CLOSE UP FILM - 4MIL



PREMIUM QUALITY

608120	14' x 300' Close Up Film U.V Poly Film White- 4 mil
--------	--

ECONOMY QUALITY

60100001	14' x 300' Close Up Film U.V Poly Film White- 4 mil
----------	--

## SET-UP

### FOAM SEALER



6015550 FOAM SEALER, 5 1/2" X 50'

### RUMBLE BUTTON

1 1/8" DIA. ZINC WASHER WITH NEOPRENE BACKING FOR THE MOST RELIABLE ROOF LEAK RESISTANCE.



6001001 RUMBLE BUTTON - 100/CTN

### PIPE HANGER STRAP AND STOVE BOLTS



116507 28 GAUGE GALVANIZED  
3/4" x 100'  
1113038 STRAP, HANGER PLASTIC  
3/4" x 100'  
651434 1/4" x 3/4" STOVE BOLT  
W/ NUT - 100 BOX

### BRACE EZ JOIST



603150 BRACE EZ JOIST

### ADJUSTABLE OUTRIGGER KIT

ADJUSTS TO ASSIST DOORS AND WINDOWS TO OPERATE PROPERLY (POWDER COATED)

**NOTE:** DOES NOT REPLACE REQUIRED DOOR BLOCKING

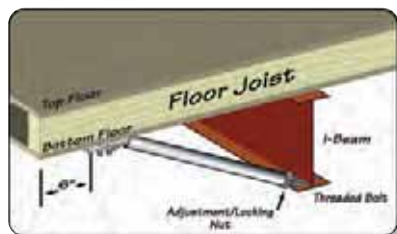

**NOTE:** KIT CONTAINS TWO OF EACH OF ITEMS SHOWN

6059363 ADJUSTABLE OUTRIGGER KIT  
FOR 12' TO 14' WIDE (2 PACK)  
6059365 ADJUSTABLE OUTRIGGER KIT  
FOR 16' WIDE (2 PACK)

### METAL FLASHING



60850 8" x 50' ALUMINUM  
601050 10" x 50' ALUMINUM  
6010501 10" x 50' GALVANIZED



# The Minute Man Foundation System for All Wind Zones Saves Time & Money!

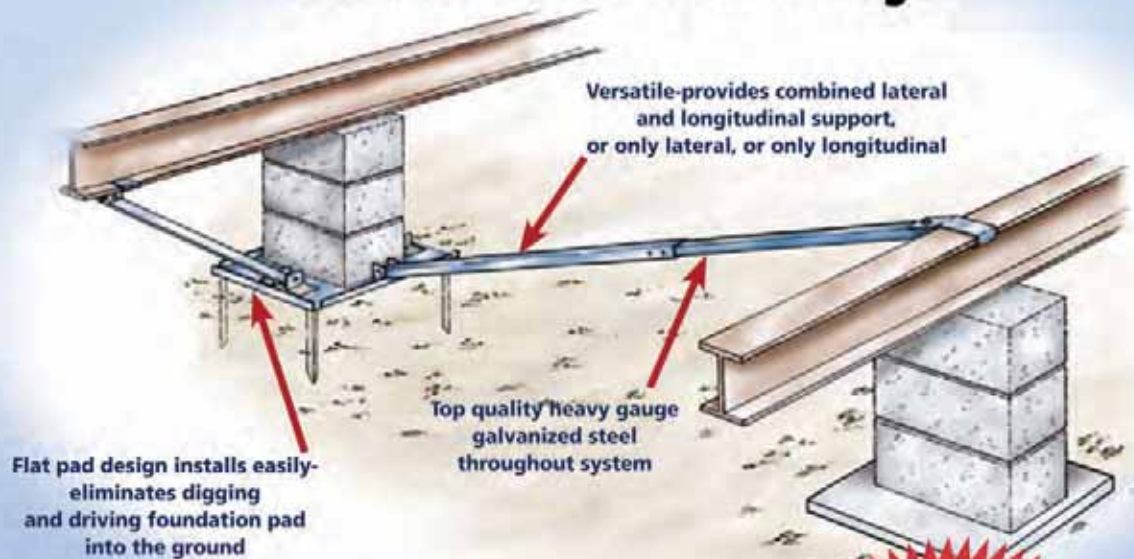

**Minute Man's superior design outperforms other brands in so many ways:**

- Can eliminate or reduce frame ties, anchors and stabilizers
- Versatile and interchangeable parts easily adapt to most any foundation requirements on homes being manufactured today
- Top quality heavy gauge galvanized steel provides stability
- Adaptable to steel piers, concrete block piers and poured foundations; 20" x 20" steel pad will hold double block piers
- Versatile-provides support as needed: combined lateral and longitudinal support, or only lateral, or only longitudinal
- Easy to install on dirt or concrete.
- Neatly packaged for warehousing and transport to job site; Lateral and Longitudinal Tubes conveniently packaged in pairs with all hardware included, no separated parts to find.

# Minute Man LLBS Flex Tubes for Concrete Installation!

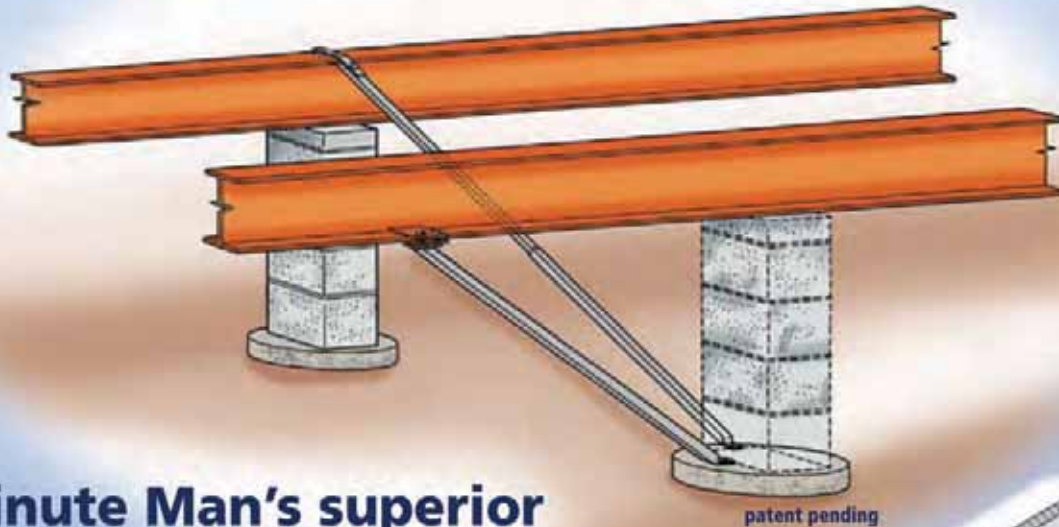

**Minute Man's superior design still outperforms the other brands in so many ways:**

- 4-ply folded tube for a stronger connection to the concrete
- Tubes connect directly to concrete with only one anchor bolt; less parts, less drilling
- Tubes can fit on smaller concrete footers
- Tubes easily flex from 10 degrees to 45 degrees
- Pre-assembled Beam Clips on Longitudinal Tubes
- Neatly packaged for warehousing and transport to job site; Lateral and Longitudinal Tubes conveniently packaged in pairs with all hardware included, no separated parts to find.

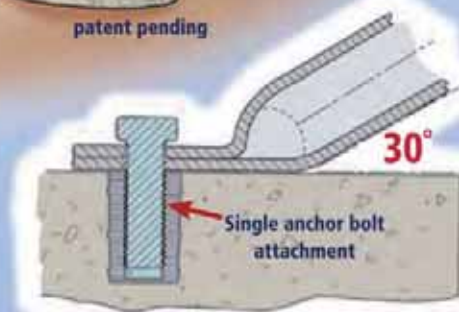

Each longitudinal or lateral Flex Tube is pre-bent to 30 degrees

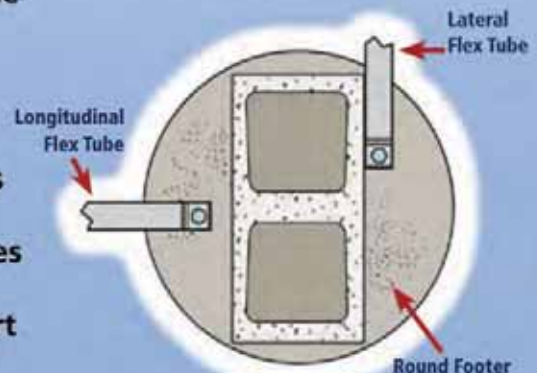

*Minute Man* Anchors, Inc.  
 We keep things down to earth...

# Minute Man Anchors

## SOIL INSTALLATION COMPONENTS

### LATERAL SYSTEM

#### with 20" Steel Pier Pad

##### System Components-

- (1) Galvanized 20" Steel Pier Pad,
- (1) Galv. 60" Adj. Lateral Brace Tube w/Hardware

- #483521 Galv. Steel Pier Pad w/16" pins
- #483532N Galv. 60" Adj. Lateral Brace Tube w/Hardware
- #483537 Galv. 72" Adj. Lateral Brace Tube w/Hardware

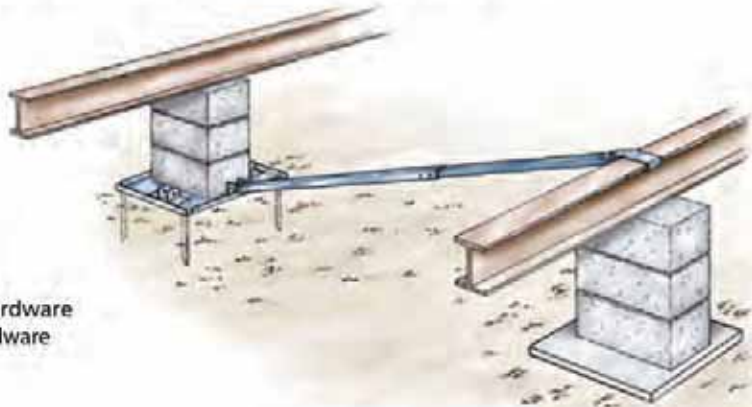

### LATERAL & LONGITUDINAL SYSTEM

#### with 20" Steel Pier Pad

##### System Components-

- (1) Galvanized 20" Steel Pier Pad,
- (1) Galvanized Lateral Brace Tube
- (1) Galv. Longitudinal Brace Tube w/Beam Clip

- #483521 Galv. Steel Pier Pad w/16" pins
- #483532N Galv. 60" Adj. Lateral Brace Tube w/Hardware
- #483739 Galv. 39" Longitudinal Brace Tube w/Beam Clip for piers up to 24"
- #483744 Galv. 44" Longitudinal Brace Tube w/Beam Clip for piers up to 32"
- #483753 Galv. 53" Longitudinal Brace Tube w/Beam Clip for piers up to 40"
- #483765 Galv. 65" Longitudinal Brace Tube w/Beam Clip for piers up to 48"

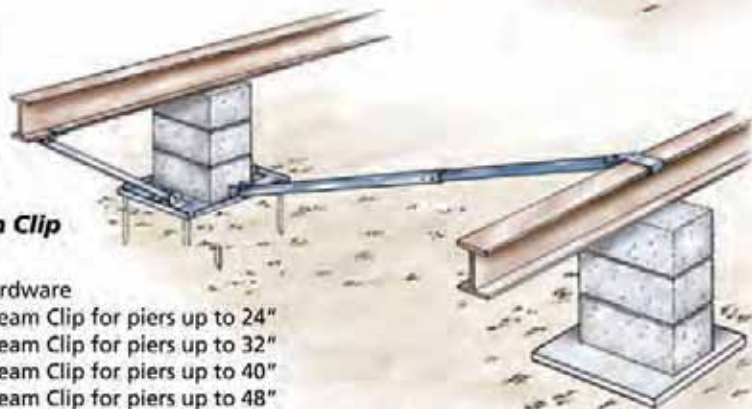

ALL PARTS CONTAINED IN ONE NEAT PACKAGE FOR YOUR CONVENIENCE!

#### Lateral Brace Tubes Hardware

- 2 2" x 7-3/4" Lateral Clamps (top of beam)
- 2 1-5/8" x 2" Tube Clamps
- 2 1/2" x 1-3/8" Washers
- 2 1/2" x 1-1/2" Carriage Bolts & Nuts
- 4 1/2" x 2-1/2" Carriage Bolts & Nuts
- 8 1/4" x 3/4" Self Drilling Screws



#### Longitudinal Brace Tubes w/Beam Clips

- 2pk 1-1/2" sq. Galv. Steel Tube x 39", 44", 53" or 65" long
- 2 Pre-Assembled Beam Clips
- 1 Box Hardware

#### Logitudinal Brace Tubes Hardware

- 4 3-3/4" x 2-3/4" Top Cover Attachment Clips
- 8 1/2" x 1-1/4" Carriage Bolts & Nuts



#### 60" Adjustable Lateral Brace Tubes

- 2 1-1/2" sq. x 60" Galv. Steel Outer/Lower Tubes
- 2 1-1/4" sq. x 60" Galv. Steel Inner/Upper Tubes
- 1 Box Hardware (see below)
- (72" available as special order)



Uses adjustable galvanized tubing for easy assembly and structural integrity

Prices and specifications subject to change without notice. ALWAYS Refer to Minute Man Anchors installation instructions for your particular home, wind zone, and local jurisdiction.



Flat pad design installs easily on concrete or on soil and provides a sturdy, tight fit

#### Steel Pier Pad Assembly

- 1 20" Galv. Steel Pier Pad
- 4 16" Angle Drive Pins
- 2 1/2' x 2-1/2" Carriage Bolts & Nuts

ALWAYS Refer to Minute Man Anchors installation instructions for your particular home, wind zone, and local jurisdiction.

# Minute Man Anchors

## CONCRETE INSTALLATION COMPONENTS

### LATERAL SYSTEM

#### For Concrete Flex Tube

##### System Components-

##### (1) Galv. 60" Adj. Lateral Brace Tube w/Hardware

- #483632 Galv. 60" Adj. Lateral Brace Tube w/Hardware
- #483637 Galv. 72" Adj. Lateral Brace Tube w/Hardware
- #483636 J-Hook LLBS wet set

### LATERAL & LONGITUDINAL SYSTEM

#### For Concrete Flex Tubes

##### System Components-

##### (1) Galvanized 60" Adj. Lateral Brace Tube w/Hardware

##### (1) Galv. Longitudinal Brace Tube w/Beam Clip

- #483639 Galv. 39" Longitudinal Flex Tube for piers up to 24"
- #483644 Galv. 44" Longitudinal Flex Tube for piers up to 32"
- #483653 Galv. 53" Longitudinal Flex Tube for piers up to 40"
- #483665 Galv. 65" Longitudinal Flex Tube for piers up to 48"

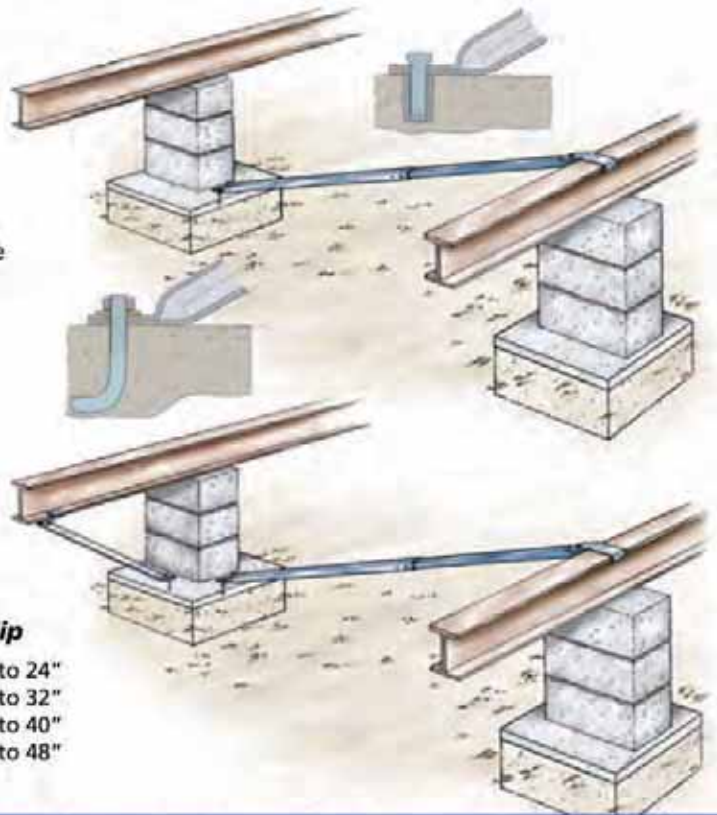

### ALL PARTS CONTAINED IN ONE NEAT PACKAGE FOR YOUR CONVENIENCE!



#### Lateral Brace Tubes Hardware

- 2 2" x 7-3/4" Lateral Clamps (top of beam)
- 2 1/2" x 1-3/8" Washers
- 2 1/2" x 2-1/2" Carriage Bolts & Nuts
- 8 1/4" x 3/4" Self Drilling Screws
- 2 5/8" x 3" Sleeve Anchors (for dry concrete)

#### 60" Adjustable Lateral Brace Tubes

- 2 1-1/2" sq. x 60" Galv. Steel Outer/Lower Tubes
- 2 1-1/4" sq. x 60" Galv. Steel Inner/Upper Tubes
- (72" available as special order)

Box of Hardware and Instruction Sheet



#### Logitudinal Brace Tubes Hardware

- 4 3-3/4" x 2-3/4" Top Cover Attachment Clips
- 8 1/2" x 1-1/4" Carriage Bolts & Nuts
- 2 5/8" x 3" Sleeve Anchors (for dry concrete)

#### Longitudinal Brace Tubes w/Beam Clips

- 2pk 1-1/2" sq. Galv. Steel Tube x 39", 44", 53" or 65" long
- 2 Pre-Assembled Beam Clips
- 1 Box Hardware

Box of Hardware and Instruction Sheet



ALWAYS Refer to Minute Man Anchors installation instructions for your particular home, wind zone, and local jurisdiction.





## Vector Systems: Lateral Stabilization

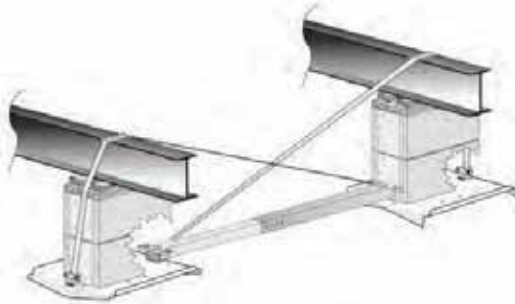

**Vector System**  
 For Lateral Stabilization  
 Block Pads  
 Part #4859018  
 Kit includes: 2 pans, swivel straps, strap protectors,  
 pan connectors, slotted bolts & Hardware.  
 Optional: Steel Compression Member

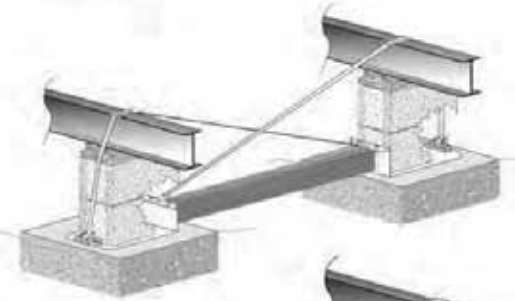

**Vector System**  
 For Lateral Stabilization for Concrete (Single Block)  
 Part #4859036  
 Kit includes: 2 concrete pans, swivel straps, strap  
 protectors, concrete brackets, slotted bolts  
 & Hardware.  
 Optional: Steel Compression Member

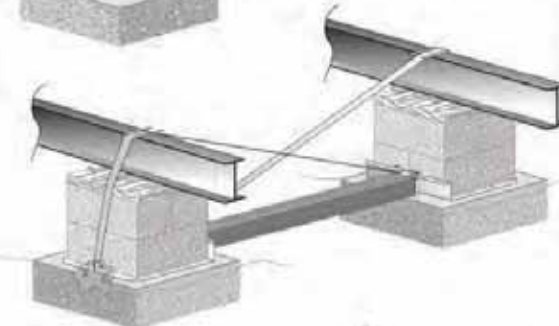

**Vector System**  
 For Lateral Stabilization for Concrete (Double Block)  
 Part #4859049  
 Kit includes: 2 concrete pans, swivel straps, strap  
 protectors, concrete brackets, slotted bolts  
 & Hardware.  
 Optional: Steel Compression Member

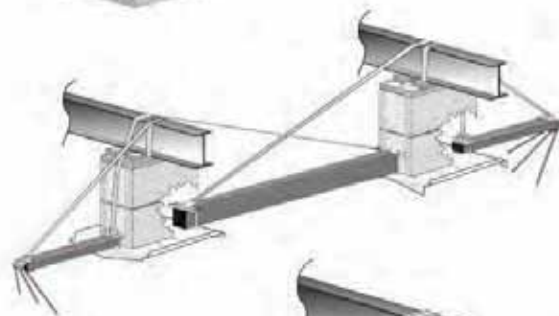

**Vector System**  
 For Lateral Stabilization Difficult/Rocky Soils.  
 For use on single section units only.  
 Kit includes: 2 adapter heads and 6 rods  
 Must be used with:  
 #4859018 - Vector for single/double block pads

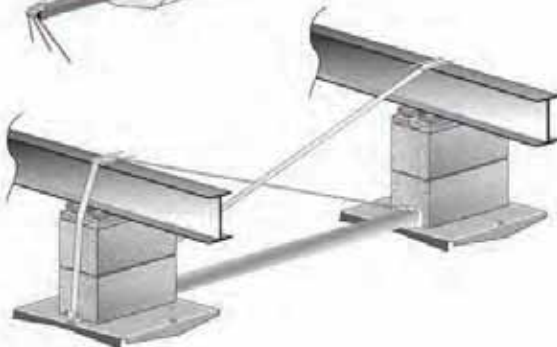

**3 Sq. Ft. Pad Vector System**  
 Part #4859271 - Vector 3 Sq. Ft. pad  
 (sold individually, 2 required for lateral,  
 1 for longitudinal systems)

Part #4859024 - Vector Lateral Hardware Kit (Florida)  
 Kit Includes: U-bolts, strap protectors,  
 pan connectors, PVC adapter, nuts & bolts  
 (swivel strap and slotted bolts not included)

## Vector Systems: Longitudinal Stabilization

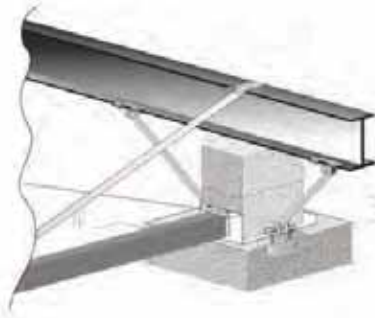

### Longitudinal Stabilization Hardware Kit for Concrete

Part #4859023 - Includes 2 beam clamps, tension brackets, nuts and bolts. (for use with #4859036 & 4859049, longitudinal struts not included)

Part #4810733-Vector Long Hardware Kit

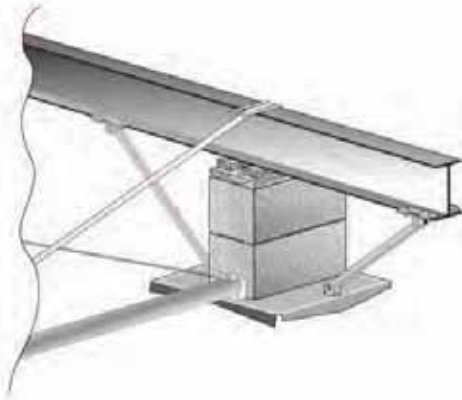

### 3 Sq. Ft. Pad Vector Longitudinal System

Part #4859026

Kit Includes: 2 beam clamps, 2 tension brackets, nuts & bolts. (for use with #4859271, longitudinal struts not included)

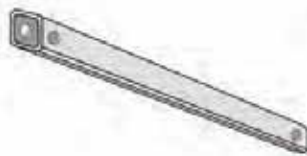

### Struts for Longitudinal Systems

Part #	Length	Pier Height
#4859016	30"	up to 2 Blocks
#4859012	39"	up to 3 Blocks
#4859013	44"	up to 4 Blocks
#4859014	53"	up to 5 Blocks
#4859015	65"	up to 6 Blocks

## Xi2 Ground Foundation System

“ Two Systems for Most States Except Florida and California”



Shown with two longitudinal struts for Wind Zones II & III

**Longitudinal Hardware Kit**

Part #4859331- Includes hardware for 2 struts: I-beam brackets, U-bolts, nuts, bolts and washers

Part No.	Length	Pier Height
#4859330-30	30"	up to 2 Blocks
#4859330-39	39"	up to 3 Blocks
#4859330-44	44"	up to 4 Blocks
#4859330-53	53"	up to 5 Blocks
#4859330-65	65"	up to 6 Blocks

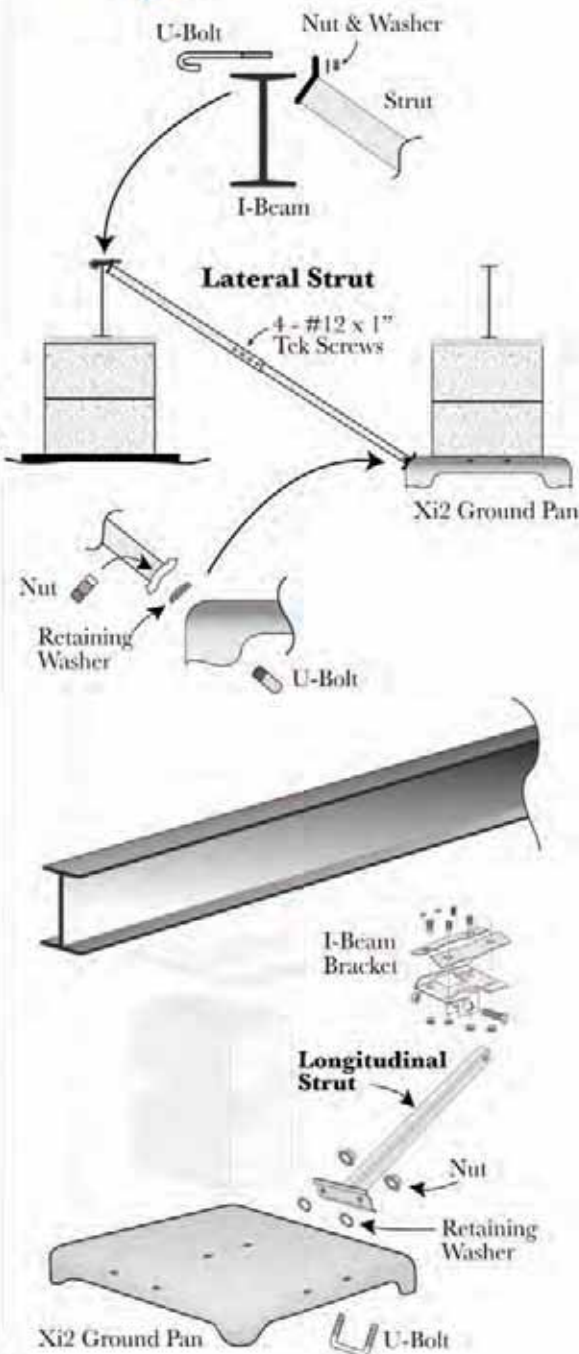

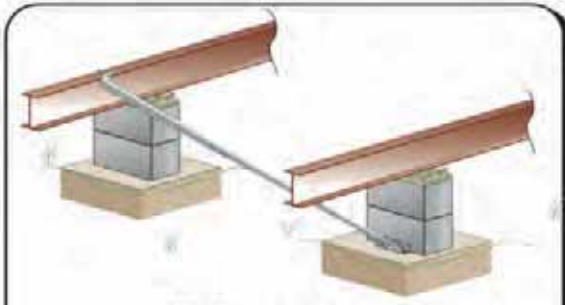

**Xi2 Concrete Systems**

Includes: 5' Strut, Bracket, & Hardware  
 "Dry Set" Concrete System Part #4859307  
 "Wet Set" Concrete System Part #4859328  
 Hardware Kit Concrete System Part #485963

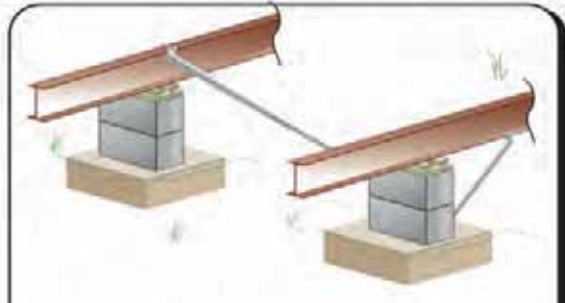

**Longitudinal Hardware Kit**

Part # 4859263—Includes hardware for 2 struts:  
 I beam bracket, nuts, bolts and washers

**Longitudinal Struts for "Concrete Systems"**

Part No.	Length	Pier Height
#4859016	30"	up to 2 Blocks
#4859012	39"	up to 3 Blocks
#4859013	44"	up to 4 Blocks
#4859014	53"	up to 5 Blocks
#4859015	65"	up to 6 Blocks

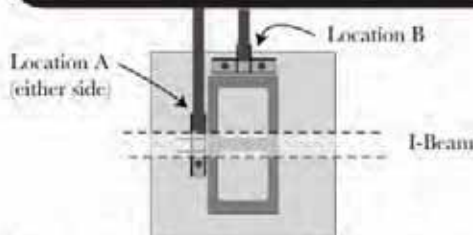

Lateral Stabilization with Concrete Brackets can be mounted in two locations

**Xi2 Concrete Foundation System**  
 "Two Systems for Most States Except Florida and California"

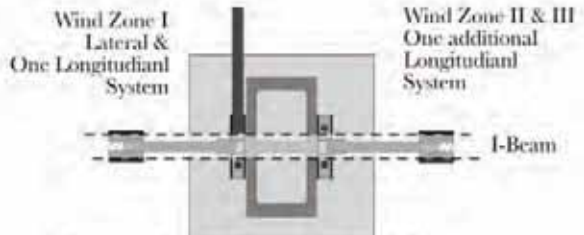
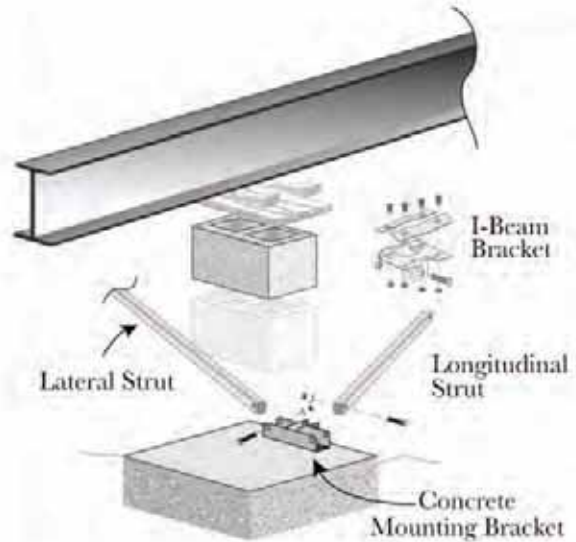
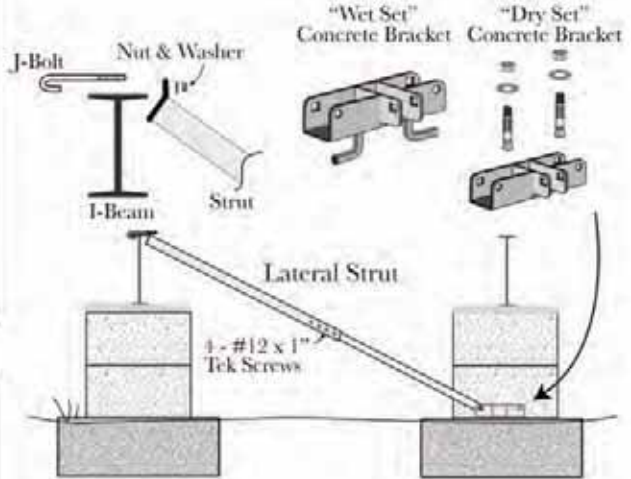

Longitudinal Stabilization with Concrete Brackets can only be mounted in location "A" with lateral strut



## Xi Steel Pier System

**Xi Steel Pier with Longitudinal System**  
Includes: steel pier/longitudinal struts and foundation base pad  
4859321- Xi, for 12" Height  
4859314- Xi, for 25.5" Height  
4859317- Xi, for 36" Height

**Lateral Stabilization Struts**  
Steel Piers can be combined with one of the following for lateral support:  
4859345 - Xi, Lateral Strut, 5' w/hardware  
4859348 - Xi, Lateral Strut, 6' w/hardware

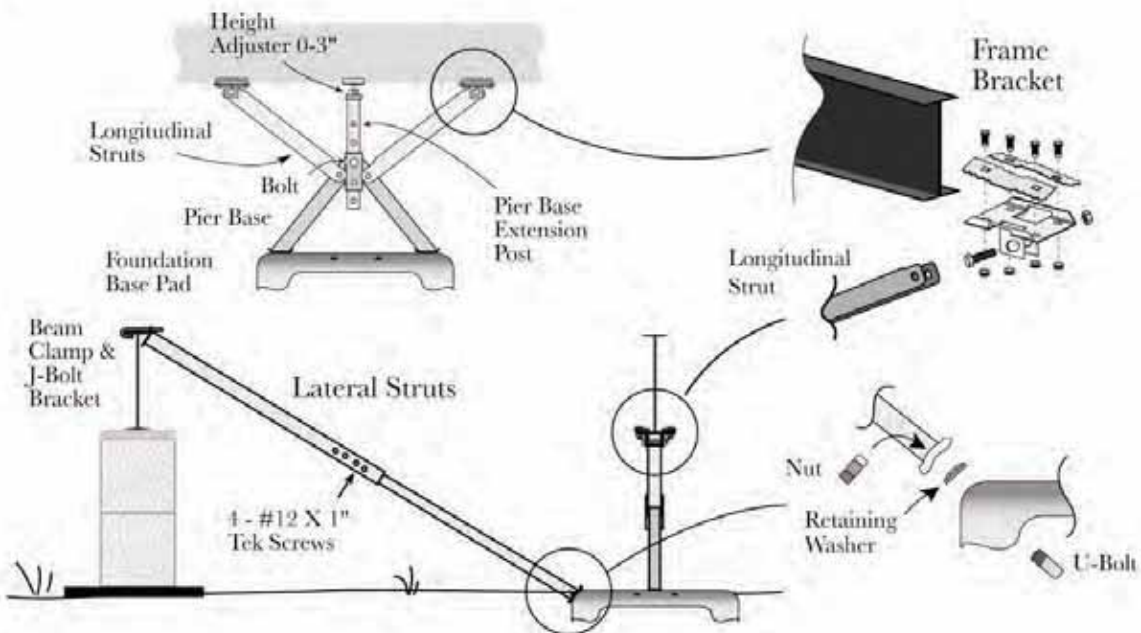

# SET-UP

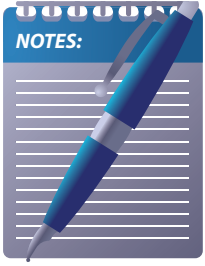

Four horizontal lines for writing, alternating between light blue and light green backgrounds.

Main body of the page consisting of 20 horizontal lines for writing, alternating between light blue and light green backgrounds.



PRODUCTS THAT **REVOLUTIONIZE** HOW  
MANUFACTURED HOUSING DEFINES **COMFORT.**



INDOOR COMFORT PRODUCTS

# Revolv®

STYLECREST®





# HEATING & AIR CONDITIONING

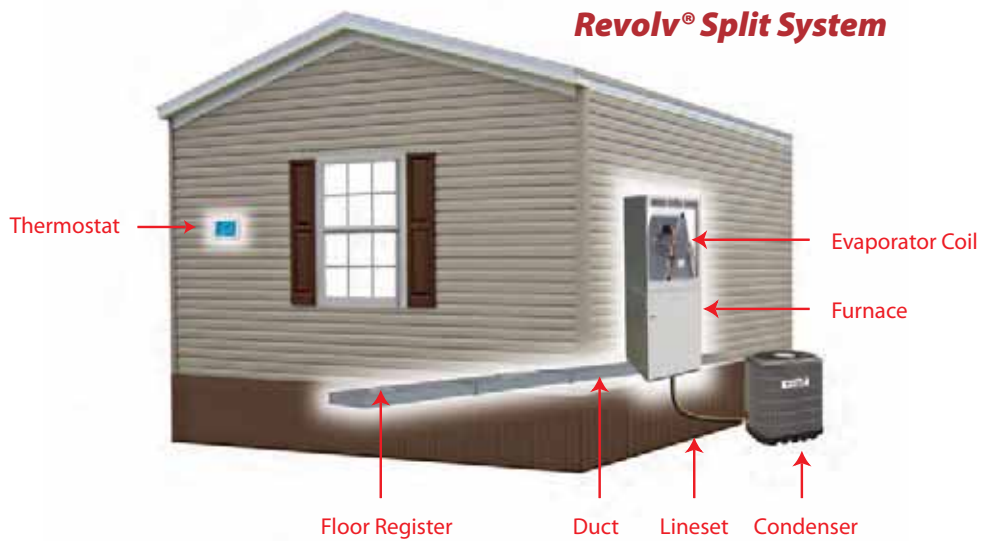

**Revolv® Split System** – This describes an air conditioning or heat pump system that is split into two sections - an outdoor section and an indoor section. A typical split system is an air conditioning condensing unit on a pad on the outside of the home, with a furnace or air handler inside the home.

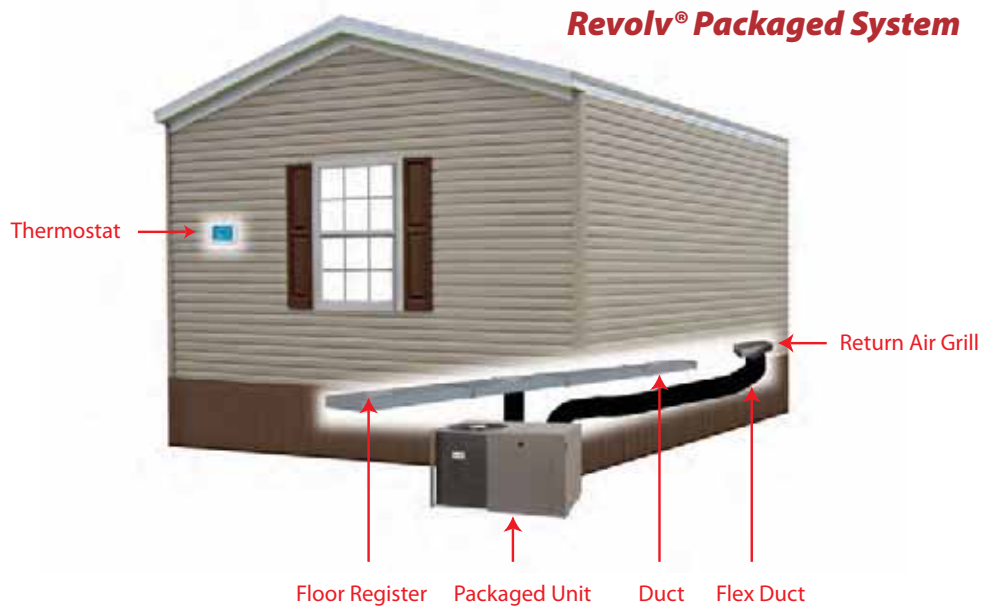

**Revolv® Packaged System** – Packaged units provide both heating and cooling from one unit that is placed outside the home. Packaged units are available in several combinations of fuel sources - gas heat/electric cooling; heat pump and electric heat/electric cooling.

# HEATING & AIR CONDITIONING

## HVAC TERMINOLOGY AND DEFINITIONS

**HVAC** - Heating, Ventilation and Air Conditioning.

**AFUE** - An acronym which stands for Annual Fuel Utilization Efficiency wherein the higher the number, the more efficient the unit is rated. The Department of Energy's (DOE) minimum efficiency level is 80%.

**Air Handler** - This is the indoor section of a split system, also known as a fan coil, which serves to move air through your duct work via a blower motor.

**Ambient Temperature** - This is the air temperature surrounding the particular piece of equipment.

**BTU** - An acronym which stands for British Thermal Unit (Btu). This is the amount of heat required to raise the temperature of one pound of water by one degree Fahrenheit. These ratings are available on all hvac units. The heating Btu rating and air conditioner Btu rating typically are not the same for a single system.

**Condensing Unit** - This is the outdoor section of a split system air conditioning system which cools refrigerant that circulates in the HVAC system. This unit requires periodic cleaning to operate efficiently.

**EER** - is an abbreviation for Energy Efficiency Rating. The Air-Conditioning and Refrigeration Institute standardized this rating, which reports central air conditioning efficiency at 80 degrees F indoors and 95 degrees F outdoors. This rating measures steady-state efficiency — that is, the efficiency of the air conditioner once it is up and running.

**Energy Star** — HVAC products with the ENERGY STAR symbol are deemed to be environmentally friendly by meeting strict energy efficiency guidelines set by the EPA and the DOE.

**Evaporator Coil** — This element transfers heat to provide cooled, dehumidified air into your home or business. This element needs periodic cleaning to work efficiently.

**Heat Pump** — Provides heating and cooling comfort as a split system or as a packaged system. A heat pump can be combined with a gas furnace for better performance when temperatures fall below freezing.

**HSPF** - An acronym which stands for Heating Season Performance Factor and indicates the comparative level of a heat pumps' heating efficiency. A higher HSPF number indicates greater efficiency.

**Latent heat** - is the energy absorbed by or released from a substance during a phase change from a gas to a liquid or a solid or vice versa. If a substance is changing from a solid to a liquid, for example, the substance needs to absorb energy from the surrounding environment in order to spread out the molecules into a larger, more fluid volume. If the substance is changing from something with lower density, like a gas, to a phase with higher density like a liquid, the substance gives off energy as the molecules come closer together and lose energy from motion and vibration.

**Packaged System** - Packaged units provide both heating and cooling from one unit that is placed outside the home or business. Packaged units are available in several combinations of fuel sources - gas heat/electric cooling; heat pump; electric heat/electric cooling; oil heat/electric cooling.

**Sensible heat** - is the energy required to change the temperature of a substance with no phase change. This is what the thermostat and thermometer registers.

**SEER Rating** - A measurement of the efficiency of cooling products which stands for Seasonal Energy Efficiency Rating. Higher SEER ratings indicate higher energy efficiency. SEER rating is generally more important than the size of your air conditioning unit.

**Split System** - This describes an air conditioning or heat pump system that is split into two sections - an outdoor section and an indoor section. A typical split system is an air conditioning condensing unit on a concrete pad on the outside of the home with a furnace and air handler inside the home.

**Thermocouple/Flame Sensor** - Control and safety devices designed to detect and respond to the presence of a flame.

**Thermostat** - is a control device located inside your home or office used to set, maintain and control temperature levels. A thermostat will automatically turn on an HVAC system to maintain a preset temperature level and should not be used as a switch. Thermostats must be matched to the type of system used and wired accordingly.

**Ton** - A measurement of the capacity of an air conditioning system (not weight). One ton of air conditioning equals 12,000 Btus per hour. This means that a "one ton" air conditioning system has the capability of removing 12,000 Btus of heat per hour from your home or business.



# Split System AccuCharge<sup>®</sup> 13 SEER Air Conditioners

## Features and Benefits

**Composite Base Pan** – Absorbs sound and is corrosion resistant. Composite is also stronger and lighter than steel.

**Micro-Channel Coils** – All aluminum coils in all models which provides high corrosion resistance.

**High Pressure Switch** – Protects against abnormally high system pressures. Auto-reset feature prevents nuisance service visits.

**Louvered Condenser Guard** – Durable metal guard protects the coil from yard hazards and extreme weather.

**Designed Using Galvanized Steel** – With a polyester urethane coat finish. The 950 hour salt spray finish resists corrosion 50% better than comparable units.

**AccuCharge<sup>®</sup> with FitRight<sup>®</sup> fittings** – Correctly charged for fast easy installations.

**Filter-Drier** – Factory Installed.



CUTAWAY VIEW OF FITRIGHT<sup>®</sup> FITTING

## Warranty

**5 Years Parts / 1 Year Labor \***

\* To receive 10-year Parts

Limited Warranty, online registration of unit must be completed within 60 days of installation.

Visit [www.stylecrestinc.com](http://www.stylecrestinc.com) for warranty registration



# Revolv® Split System AccuCharge® A/C 13 SEER

REVOLV® SPLIT SYSTEM AccuCharge® AIR CONDITIONERS 13 SEER						
Tons Nominal <sup>^</sup>	Outdoor Unit	Tube In Fin Coil	Micro Channel Coil	Vapor Line	Liquid Line	Pad Size
2.0	RSC1324	1836M4A	C8QAM024U-B	3/4"	3/8"	24" x 24"
2.5	RSC1330	1836M4A	C8QAM030U-B	3/4"	3/8"	24" x 24"
3.0	RSC1336	1845M4A	C8QAM036U-B	7/8" *	3/8"	24" x 24"
3.5	RSC1342	1845M4A	N/A	7/8"	3/8"	32" x 32"
4.0	RSC1348	187848M4A/1847M4A	N/A	7/8"	3/8"	32" x 32"

<sup>^</sup>Refer to AHRI listings for actual applications and capacities

\* 3/4" up to 24' length

REVOLV® SPLIT SYSTEM AccuCharge® AIR CONDITIONERS		
Unit SKU	AHRI Model #	Description
RSC1324	RS4QD-024KC	CONDENSER-QC-AC-13S-2.0T
RSC1330	RS4QD-030KC	CONDENSER-QC-AC-13S-2.5T
RSC1336	RS4QD-036KC	CONDENSER-QC-AC-13S-3.0T
RSC1342	RS4QD-042KD	CONDENSER-QC-AC-13S-3.5T
RSC1348	RS4QD-048KC	CONDENSER-QC-AC-13S-4.0T

REVOLV® SPLIT SYSTEM AccuCharge® 13 SEER AIR CONDITIONER DIMENSIONS			
Unit SKU	(D) Depth	(W) Width	(H) Height
RSC1324	22 3/4"	22 3/4"	25"
RSC1330	22 3/4"	23 3/4"	29"
RSC1336	22 3/4"	23 3/4"	29"
RSC1342	30 3/4"	30 3/4"	29"
RSC1348	30 3/4"	30 3/4"	29"



**Features:**

- Mounted TXV sensor bulb
- AccuCharge® Fit-Right® fittings
- Factory installed TXV valve suitable for A/C or H/P applications
- Coil has built-in strainer for coil protection
- UL<sup>®</sup> listed and leak tested to 500 p.s.i. Code approved 2-opening drain pan
- Dry-type pan does not maintain standing water
- Kit contains drain hose, fittings, and furnace cover plates for gas/oil furnaces





# Split System AccuCharge<sup>®</sup> 14 SEER Air Conditioners

## Features and Benefits

**Composite Base Pan** – Absorbs sound and is corrosion resistant. Composite is also stronger and lighter than steel.

**Micro-Channel Coils** – All aluminum coils in all models which provides high corrosion resistance.

**High Pressure Switch** – Protects against abnormally high system pressures. Auto-reset feature prevents nuisance service visits

**Louvered Condenser Guard** – Durable metal guard protects the coil from yard hazards and extreme weather.

**Designed Using Galvanized Steel** – With a polyester urethane coat finish. The 950 hour salt spray finish resists corrosion 50% better than comparable units.

**AccuCharge<sup>®</sup> with FitRight<sup>®</sup> fittings** – Correctly charged for fast easy installations.

**Filter-Drier** – Factory Installed.



CUTAWAY VIEW OF FITRIGHT<sup>®</sup> FITTING

## Warranty

**5 Years Parts / 1 Year Labor \***

\* To receive 10-year Parts

Limited Warranty, online registration of unit must be completed within 60 days of installation.

Visit [www.stylecrestinc.com](http://www.stylecrestinc.com) for warranty registration



# Revolv® Split System AccuCharge® A/C 14 SEER

REVOLV® SPLIT SYSTEM AccuCharge® AIR CONDITIONERS 13 SEER						
Tons Nominal <sup>^</sup>	Outdoor Unit	Micro Channel Coil	Tube in Fin Coil	Vapor Line	Liquid Line	Pad Size
2.0	RSC1424	C8QAMX24U-B	1836M4A	3/4"	3/8"	24" x 24"
2.5	RSC1430	C8QAMX30U-B	1836M4A	3/4"	3/8"	32" x 32"
3.0	RSC1436	C8QAMX36U-B	187848M4A/1845M4A	7/8" *	3/8"	32" x 32"
3.5	RSC1442	C8QAMX42U-B	187848M4A/1845M4A	7/8"	3/8"	32" x 32"
4.0	RSC1448	C8QAMX48U-B	187848M4A//1847M4A	7/8"	3/8"	32" x 32"

<sup>^</sup>Refer to AHRI listings for actual applications and capacities

\* 3/4" up to 24' length

REVOLV® SPLIT SYSTEM AccuCharge® AIR CONDITIONERS		
Unit SKU	AHRI Model #	Description
RSC1424	RS4QE-024KB	CONDENSER-QC-AC-14S-2.0T
RSC1430	RS4QE-030KB	CONDENSER-QC-AC-14S-2.5T
RSC1436	RS4QE-036KA	CONDENSER-QC-AC-14S-3.0T
RSC1442	RS6QF-042K	CONDENSER-QC-AC-14S-3.5T
RSC1448	RS6QF-048K	CONDENSER-QC-AC-14S-4.0T

REVOLV® SPLIT SYSTEM AccuCharge® AIR CONDITIONER DIMENSIONS			
Unit SKU	(D) Depth	(W) Width	(H) Height
RSC1424	22 3/4"	22 3/4"	33"
RSC1430	30 3/4"	30 3/4"	29"
RSC1436	30 3/4"	30 3/4"	37"
RSC1442	30 3/4"	30 3/4"	45"
RSC1448	30 3/4"	30 3/4"	45"





# Split System AccuCharge® 14 SEER Heat Pumps

## Features and Benefits

**Composite Base Pan** – Absorbs sound and is corrosion resistant. Composite is also stronger and lighter than steel.

**Micro-Channel Coils** – All aluminum coils in all models which provides high corrosion resistance.

**High Pressure Switch** – Protects against abnormally high system pressures. Auto-reset feature prevents nuisance service visits.

**Louvered Condenser Guard** – Durable metal guard protects the coil from yard hazards and extreme weather.

**Designed Using Galvanized Steel** – With a polyester urethane coat finish. The 950 hour salt spray finish resists corrosion 50% better than comparable units.

**AccuCharge® with FitRight® fittings** – Correctly charged for fast easy installations

**Outdoor Thermostat** – Factory Supplied, Field installed.

**Filter-Drier** – Factory Installed.



CUTAWAY VIEW OF FITRIGHT® FITTING

## Warranty

**5 Years Parts / 1 Year Labor \***

\* To receive 10-year Parts

Limited Warranty, online registration of unit must be completed within 60 days of installation.

Visit [www.stylecrestinc.com](http://www.stylecrestinc.com) for warranty registration



# Revolv® Split System AccuCharge® H/P 14 SEER

REVOLV® SPLIT SYSTEM QC HEAT PUMPS 14 SEER					
Tons Nominal <sup>^</sup>	Outdoor Unit	Coil	Vapor Line	Liquid Line	Pad Size
2	RSH1424	C8QAMX24U-B	¾"	⅜"	32" x 32"
2.5	RSH1430	C8QAMX30U-B	¾"	⅜"	32" x 32"
3	RSH1436	C8QAMX36U-B	⅞"	⅜"	32" x 32"
3.5	RSH1442	C8QAMX42U-B	⅞"	⅜"	32" x 32"
4	RSH1448	C8QAMX49U-B	⅞"	⅜"	32" x 32"

<sup>^</sup>Refer to AHRI listings for actual applications and capacities

REVOLV® SPLIT SYSTEM HEAT PUMPS		
Unit SKU	AHRI Model #	Description
RSH1424	RT4QE-024KA	CONDENSER-QC-HP-14S-2.0T
RSH1430	RT4QE-030KA	CONDENSER-QC-HP-14S-2.5T
RSH1436	RT4QE-036KA	CONDENSER-QC-HP-14S-3.0T
RSH1442	RT4QE-042KA	CONDENSER-QC-HP-14S-3.5T
RSH1448	RT4QE-048KA	CONDENSER-QC-HP-14S-4.0T

REVOLV® SPLIT SYSTEM HEAT PUMP DIMENSIONS			
Unit SKU	(D) Depth	(W) Width	(H) Height
RSH1424	30 ¾"	30 ¾"	33"
RSH1430	30 ¾"	30 ¾"	42"
RSH1436	30 ¾"	30 ¾"	45"
RSH1442	30 ¾"	30 ¾"	45"
RSH1448	30 ¾"	30 ¾"	45"



### Dual Fuel Kit

13010004





# MANUFACTURED HOUSING LINESETS

LINESET NOMENCLATURE									
4	4	6	3	Q	1	5	3	1	1
4=R410A, 6=Nitrogen or Open End									
Product type-4=complete Line Set. 5=Component of Line Set									
Suction line diameter-3=3/8", 2=1/4", 5=5/8", 6=3/4", 7=7/8"									
Liquid Line Diameter-1=1/8", 2=1/4", 3=3/8", 4=1/2", etc.									
Connection type-Q=QC both ends. E=QC Evap End, S=Plain End both indoor and outdoor									
Lineset length 15=15' L/S, 20=20' L/S, 25=25' L/S, 30=30' L/S, 40=40' L/S, 50=50' L/S, etc.									
Wall Insulation thickness-3=3/8" wall, 4=1/2" wall, 5=5/8" wall, 6=3/4" wall, etc.									
Sell Package quantity-1=individually boxed									

PRE-CHARGED AccuCharge® REFRIGERANT LINE SETS					
PART NUMBER	DESCRIPTION	LENGTH	LIQUID LINE DIAMETER	SUCTION LINE DIAMETER	WALL INSULATION THICKNESS
4463Q1531	LINESET-QC R410A 15' 3/8" x 3/4"-3	15'	3/8"	3/4"	3/8"
4463Q2031	LINESET-QC R410A 20' 3/8" x 3/4"-3	20'	3/8"	3/4"	3/8"
4463Q2531	LINESET-QC R410A 25' 3/8" x 3/4"-3	25'	3/8"	3/4"	3/8"
4463Q3031	LINESET-QC R410A 30' 3/8" x 3/4"-3	30'	3/8"	3/4"	3/8"
4463Q4031	LINESET-QC R410A 40' 3/8" x 3/4"-3	40'	3/8"	3/4"	3/8"
4463Q5031	LINESET-QC R410A 50' 3/8" x 3/4"-3	50'	3/8"	3/4"	3/8"
4473Q1531	LINESET-QC R410A 15' 3/8" x 7/8"-3	15'	3/8"	7/8"	3/8"
4473Q2031	LINESET-QC R410A 20' 3/8" x 7/8"-3	20'	3/8"	7/8"	3/8"
4473Q2531	LINESET-QC R410A 25' 3/8" x 7/8"-3	25'	3/8"	7/8"	3/8"
4473Q3031	LINESET-QC R410A 30' 3/8" x 7/8"-3	30'	3/8"	7/8"	3/8"
4473Q4031	LINESET-QC R410A 40' 3/8" x 7/8"-3	40'	3/8"	7/8"	3/8"
4473Q5031	LINESET-QC R410A 50' 3/8" x 7/8"-3	50'	3/8"	7/8"	3/8"



LINESET WITH FitRight® FITTINGS



OIL PACKET



FitRight® FITTINGS





# Split System Sweat Fit 13 SEER Air Conditioners

## Features and Benefits

**Composite Base Pan** – Absorbs sound and is corrosion resistant. Composite is also stronger and lighter than steel.

**Micro-Channel Coils** – All aluminum coils in all models which provides high corrosion resistance.

**High Pressure Switch** – Protects against abnormally high system pressures. Auto-reset feature prevents nuisance service visits.

**Louvered Condenser Guard** – Durable metal guard protects the coil from yard hazards and extreme weather.

**Designed Using Galvanized Steel** – With a polyester urethane coat finish. The 950 hour salt spray finish resists corrosion 50% better than comparable units.

**Filter-Drier** – Factory Supplied, Field Installed.

## Warranty

**5 Years Parts / 30 Day Labor \***

\* To receive 10-year Parts

Limited Warranty, online registration of unit must be completed within 60 days of installation.

Visit [www.stylecrestinc.com](http://www.stylecrestinc.com) for warranty registration



# Revolv® Split System Sweat Fit A/C 13 SEER

REVOLV® SPLIT SYSTEM SWEAT FIT AIR CONDITIONERS 13 SEER					
Tons Nominal <sup>^</sup>	Outdoor Unit	Tube In Fin Coil	Micro Channel Coil	Vapor Line	Liquid Line
2.0	RS4BD-024K	1836S4A	C8DAM01830U-B	3/4"	3/8"
2.5	RS4BD-030K	1836S4A	C8DAM01830U-B	3/4"	3/8"
3.0	RS4BD-036K	1854S4A/1845S4A	C8DAM036U-B	7/8" *	3/8"
3.5	RS4BD-042KB	1854S4A/1845S4A	N/A	7/8"	3/8"
4.0	RS4BD-048KB	187848S4A/1847S4A/1856S4A	N/A	7/8"	3/8"

<sup>^</sup>Refer to AHRI listings for actual applications and capacities

\* 3/4" up to 24' length

REVOLV® SPLIT SYSTEM SWEAT FIT AIR CONDITIONERS	
RS4BD-024K	CONDENSER-SF-AC-13S-2.0T
RS4BD-030K	CONDENSER-SF-AC-13S-2.5T
RS4BD-036K	CONDENSER-SF-AC-13S-3.0T
RS4BD-042KB	CONDENSER-SF-AC-13S-3.5T
RS4BD-048KB	CONDENSER-SF-AC-13S-4.0T

REVOLV® SPLIT SYSTEM SWEAT FIT 13 SEER AIR CONDITIONER DIMENSIONS				
Unit SKU	(D) Depth	(W) Width	(H) Height	Pad Size
RS4BD-024K	22 3/4"	22 3/4"	25"	24" x 24"
RS4BD-030K	22 3/4"	22 3/4"	29"	24" x 24"
RS4BD-036K	22 3/4"	22 3/4"	29"	24" x 24"
RS4BD-042KB	30 3/4"	30 3/4"	29"	32" x 32"
RS4BD-048KB	30 3/4"	30 3/4"	29"	32" x 32"



## Features and Benefits

**Factory installed** – TXV valve suitable for A/C or H/P applications.

**Coil** – Built-in strainer for coil protection.

**UL® listed** – Leak tested to 500 p.s.i. Code approved 2-opening drain pan.

**Dry-type pan** – Does not maintain standing water.

**Kit** – Contains drain hose, fittings, and furnace cover plates for gas/oil furnaces.

### Furnace Compatibility:

All standard mobile home furnaces \*

Confirm furnace coil cavity dimensions. Refer to coil dimension table on page E-15\*





# Split System Sweat Fit 14 SEER Air Conditioners

## Features and Benefits

**Composite Base Pan** – Absorbs sound and is corrosion resistant. Composite is also stronger and lighter than steel.

**Micro-Channel Coils** – All aluminum coils in all models which provides high corrosion resistance.

**High Pressure Switch** – Protects against abnormally high system pressures. Auto-reset feature prevents nuisance service visits.

**Louvered Condenser Guard** – Durable metal guard protects the coil from yard hazards and extreme weather.

**Designed Using Galvanized Steel** – With a polyester urethane coat finish. The 950 hour salt spray finish resists corrosion 50% better than comparable units.

**Filter-Drier** – Factory Supplied, Field Installed.

## Warranty

**5 Years Parts / 30 Day Labor \***

\* To receive 10-year Parts

Limited Warranty, online registration of unit must be completed within 60 days of installation.

Visit [www.stylecrestinc.com](http://www.stylecrestinc.com) for warranty registration



# Revolv® Split System Sweat Fit A/C 14 SEER

REVOLV® SPLIT SYSTEM SWEAT FIT AIR CONDITIONERS 14 SEER						
Tons Nominal <sup>^</sup>	Outdoor Unit	Micro Channel Coil	Tube in Fin Coil	Vapor Line	Liquid Line	Pad Size
2.0	RS4BE-024K	C8DAMX24U-B	1836S4A	¾"	⅜"	24" x 24"
2.5	RS4BE-030K	C8DAMX30U-B	1836S4A	¾"	⅜"	32" x 32"
3.0	RS4BE-036K	C8DAMX36U-B	187848S4A/1845S4A	⅞" *	⅜"	32" x 32"
3.5	RS6BF-042KB	C8DAMX42U-B	187848S4A/1845S4A	⅞"	⅜"	32" x 32"
4.0	RS6BF-048KB	C8DAMX48U-B	187848S4A/1847S4A	⅞"	⅜"	32" x 32"

<sup>^</sup>Refer to AHRI listings for actual applications and capacities

\* ¾" up to 24' length

REVOLV® SPLIT SYSTEM SWEAT FIT AIR CONDITIONERS	
RS4BE-024K	CONDENSER-SF-AC-14S-2.0T
RS4BE-030K	CONDENSER-SF-AC-14S-2.5T
RS4BE-036K	CONDENSER-SF-AC-14S-3.0T
RS6BF-042KB	CONDENSER-SF-AC-14S-3.5T
RS6BF-048KB	CONDENSER-SF-AC-14S-4.0T

REVOLV® SPLIT SYSTEM SWEAT FIT AIR CONDITIONER DIMENSIONS			
Unit SKU	(D) Depth	(W) Width	(H) Height
RS4BE-024K	22 ¾"	22 ¾"	33"
RS4BE-030K	30 ¾"	30 ¾"	29"
RS4BE-036K	30 ¾"	30 ¾"	37"
RS6BF-042KB	30 ¾"	30 ¾"	45"
RS6BF-048KB	30 ¾"	30 ¾"	45"





# Split System Sweat Fit 14 SEER Heat Pumps

## Features and Benefits

**Composite Base Pan** – Absorbs sound and is corrosion resistant. Composite is also stronger and lighter than steel.

**Micro-Channel Coils** – All aluminum coils in all models which provides high corrosion resistance.

**High Pressure Switch** – Protects against abnormally high system pressures. Auto-reset feature prevents nuisance service visits.

**Louvered Condenser Guard** – Durable metal guard protects the coil from yard hazards and extreme weather.

**Designed Using Galvanized Steel** – With a polyester urethane coat finish. The 950 hour salt spray finish resists corrosion 50% better than comparable units.

**Outdoor Thermostat** – Factory Supplied, Field Installed.

**Filter-Drier** – Factory Supplied, Field Installed.

## Warranty

**5 Years Parts / 30 Day Labor \***

\* To receive 10-year Parts

Limited Warranty, online registration of unit must be completed within 60 days of installation.

Visit [www.stylecrestinc.com](http://www.stylecrestinc.com) for warranty registration



# Revolv® Split System Sweat Fit H/P 14 SEER

REVOLV® SPLIT SYSTEM SWEAT FIT HEAT PUMPS 14 SEER					
Tons Nominal <sup>^</sup>	Outdoor Unit	Micro Channel Coil	Vapor Line	Liquid Line	Pad Size
2.0	RT4BE-024KA	C8DAMX24U-B	3/4"	3/8"	32" x 32"
2.5	RT4BE-030KA	C8DAMX30U-B	3/4"	3/8"	32" x 32"
3.0	RT4BE-036KA	C8DAMX36U-B	7/8"	3/8"	32" x 32"
3.5	RT4BE-042KA	C8DAMX42U-B	7/8"	3/8"	32" x 32"
4.0	RT4BE-048KA	C8DAMX49U-B	7/8"	3/8"	32" x 32"

<sup>^</sup>Refer to AHRI listings for actual applications and capacities

REVOLV® SPLIT SYSTEM SWEAT FIT HEAT PUMPS	
RT4BE-024KA	CONDENSER-SF-HP-14S-2.0T
RT4BE-030KA	CONDENSER-SF-HP-14S-2.5T
RT4BE-036KA	CONDENSER-SF-HP-14S-3.0T
RT4BE-042KA	CONDENSER-SF-HP-14S-3.5T
RT4BE-048KA	CONDENSER-SF-HP-14S-4.0T

REVOLV® SPLIT SYSTEM SWEAT FIT HEAT PUMP DIMENSIONS			
Unit SKU	(D) Depth	(W) Width	(H) Height
RT4BE-024KA	30 3/4"	30 3/4"	33"
RT4BE-030KA	30 3/4"	30 3/4"	42"
RT4BE-036KA	30 3/4"	30 3/4"	45"
RT4BE-042KA	30 3/4"	30 3/4"	45"
RT4BE-048KA	30 3/4"	30 3/4"	45"



### Dual Fuel Kit

13010004







# R410A Micro-Channel Coils

## Revolv® AccuCharge® Coils

Designed to work with AccuCharge® condensers

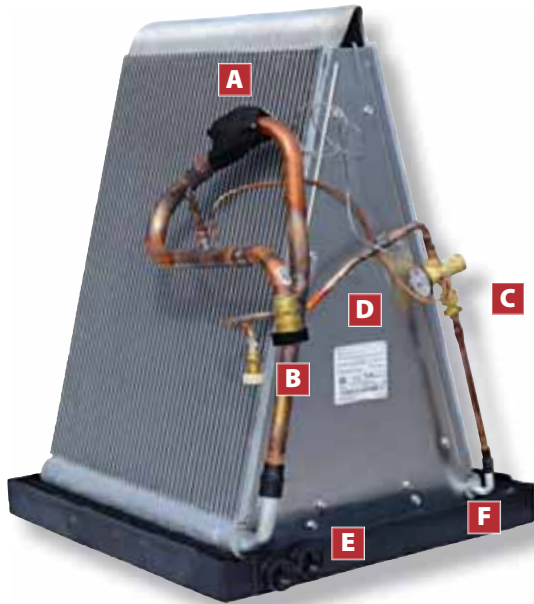

## Revolv® Sweat Fit Coils

Designed to work with Sweat Fit condensers



### Key Features

- A** Mounted TXV sensor bulb
- B** AccuCharge® with FitRight® fittings
- C** Factory installed TXV valve or piston\*
- D** Coil has built-in strainer for coil protection
- E** UL® listed and leak tested to 500 p.s.i. Code approved 2-opening drain pan
- F** Dry-type pan does not maintain standing water
- G** Kit contains drain hose, fittings, and furnace cover plates for gas/oil furnace

\* See Application guides on reverse page

# Revolv® R410A Micro-Channel Coils

AccuCharge®-A/C 14 SEER (TXV)			
Tons Nominal	Outdoor Unit Sku	Coil SKU	Coil Height (H)
2	RSC1424	C8QAMX24U-B	18"
2.5	RSC1430	C8QAMX30U-B	18"
3	RSC1436	C8QAMX36U-B	18"
3.5	RSC1442	C8QAMX42U-B	25"
4	RSC1448	C8QAMX48U-B	25"

AccuCharge®-H/P 14 SEER (TXV)			
Tons Nominal	Outdoor Unit Sku	Coil SKU	Coil Height (H)
2	RSH1424	C8QAMX24U-B	18"
2.5	RSH1430	C8QAMX30U-B	18"
3	RSH1436	C8QAMX36U-B	18"
3.5	RSH1442	C8QAMX42U-B	25"
4	RSH1448	C8QAMX49U-B	29"

AccuCharge®-A/C 13 SEER (PISTON)			
Tons Nominal	Outdoor Unit Sku	Coil SKU	Coil Height (H)
2	RSC1324	C8QAM024U-B	18"
2.5	RSC1330	C8QAM030U-B	18"
3	RSC1336	C8QAM036U-B	18"

Sweat Fit-A/C 14 SEER (TXV)			
Tons Nominal	Outdoor Unit Sku	Coil SKU	Coil Height (H)
2	RS4BE-024K	C8DAMX24U-B	18"
2.5	RS4BE-030K	C8DAMX30U-B	18"
3	RS4BE-036K	C8DAMX36U-B	18"
3.5	RS6BF-042KB	C8DAMX42U-B	25"
4	RS6BF-048KB	C8DAMX48U-B	25"

Sweat Fit-H/P 14 SEER (TXV)			
Tons Nominal	Outdoor Unit Sku	Coil SKU	Coil Height (H)
2	RT4BE-024KA	C8DAMX24U-B	18"
2.5	RT4BE-030KA	C8DAMX30U-B	18"
3	RT4BE-036KA	C8DAMX36U-B	18"
3.5	RT4BE-042KA	C8DAMX42U-B	25"
4	RT4BE-048KA	C8DAMX49U-B	29"

Sweat Fit-A/C 13 SEER (PISTON)			
Tons Nominal	Outdoor Unit Sku	Coil SKU	Coil Height (H)
2	RS4BD-024K	C8DAM024U-B	18"
2.5	RS4BD-030K	C8DAM030U-B	18"
3	RS4BD-036K	C8DAM036U-B	18"



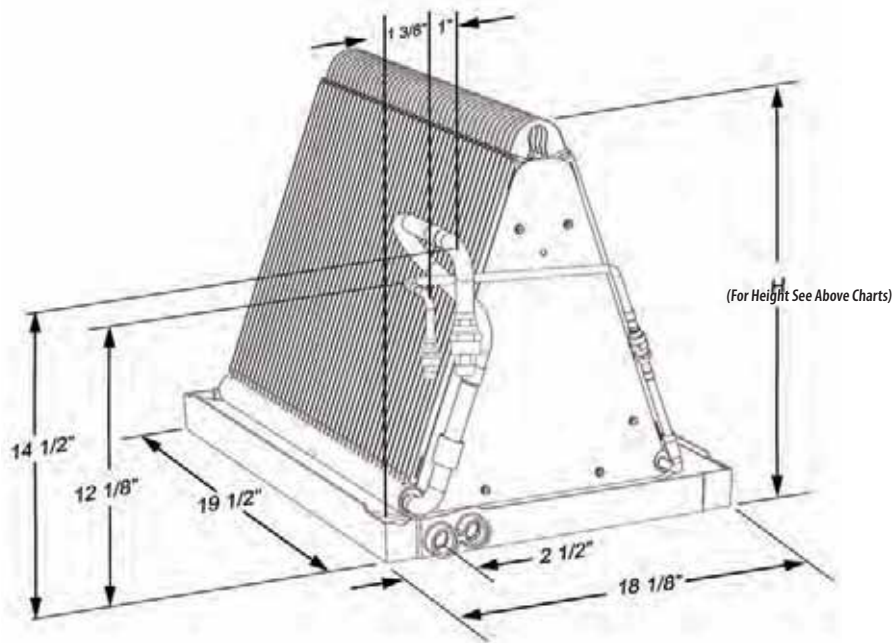

# R410A Sweat Fit Manufactured Housing Coils

The **Revolv® R410A Coil** series is designed to be "THE" A-COIL choice to be installed on new and existing down flow MH furnaces. Revolv® Coils work with many national brands in 13 and 14 SEER A/C and H/P applications. Compatible with all standard mobile home furnaces \* Special drain pans available for up flow gas/oil applications.

\* Confirm furnace coil cavity dimensions. Refer to coil dimension table.

**Revolv® Coils** work with many national brands in 13 and higher SEER A/C and H/P applications (see AHRI for specific applications)

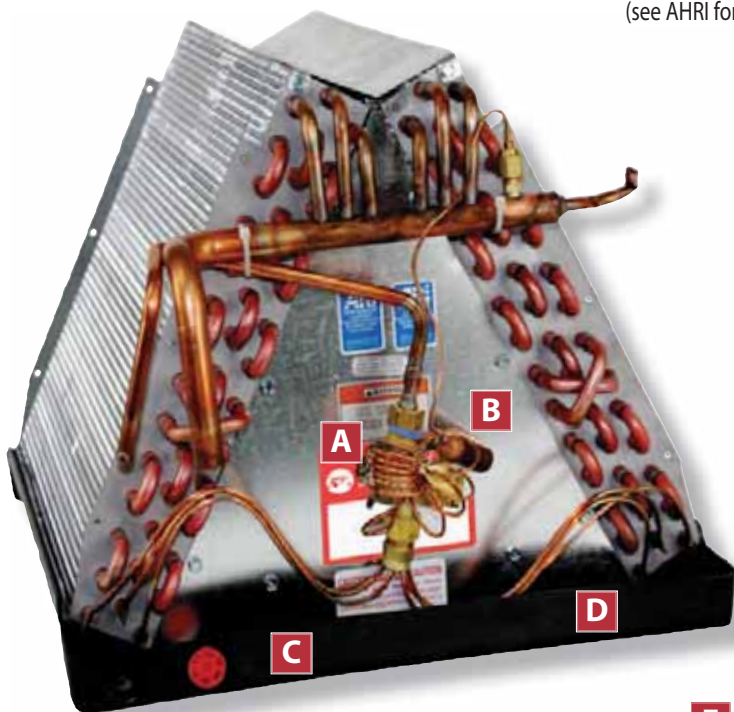

## Key Features

- A** Factory installed TXV valve suitable for A/C or H/P applications
- B** Coil has built-in strainer for coil protection
- C** UL® listed and leak tested to 500 p.s.i. Code approved 2-opening drain pan
- D** Dry-type pan does not maintain standing water
- E** Kit contains drain hose, fittings, and furnace cover plates for gas/oil furnaces

**Assembled  
in the U.S.A.** 

# Revolv® Sweat Fit Manufactured Housing Coils

REVOLV® R410A SWEAT FIT MANUFACTURED COILS				
Part Number	Description	Number of Rows	Face Area (ft2)	Height x Width x Depth H x W x D
1829S4A	COIL-REVOLV® SF R410A A/C H/P	4	4.00	18 ½" x 18" x 19 5/8"
1830S4A	COIL-REVOLV® SF R410A A/C H/P	3	3.11	14" x 18" x 19 5/8"
1836S4A	COIL-REVOLV® SF R410A A/C H/P	3	4.00	18" x 18" x 19 5/8"
1837S4A	COIL-REVOLV® SF R410A A/C H/P	4	4.86	20 ½" x 18" x 20 ½"
1844S4A	COIL-REVOLV® SF R410A A/C H/P	4	4.00	18 ½" x 18" x 19 5/8"
1845S4A	COIL-REVOLV® SF R410A A/C H/P	3	5.83	24" x 18" x 20 ½"
1847S4A	COIL-REVOLV® SF R410A A/C H/P	4	4.89	22 ½" x 18" x 19 5/8"
1851S4A	COIL-REVOLV® SF R410A A/C H/P	4	4.83	19" x 18" x 21"
1854S4A	COIL-REVOLV® SF R410A A/C H/P	4	4.00	18 ½" x 18" x 19 5/8"
1855S4A	COIL-REVOLV® SF R410A A/C H/P	4	4.44	20 ½" x 18" x 19 5/8"
1856S4A	COIL-REVOLV® SF R410A A/C H/P	4	5.33	24 ½" x 18" x 19 5/8"
187848S4A	COIL-REVOLV® SF R410A A/C H/P	4	4.54	19 ½" x 18" x 19 5/8"
*NOTE: REFER TO AHRI LISTINGS FOR ACTUAL APPLICATIONS AND CAPACITIES				
Revolv® R410A Manufactured Coil Accessories				
18R72DB003	TXV KIT R410A REVOLV®	1.5-3.0 T		
18R72DB004	TXV KIT R410A REVOLV®	2.5-5.0 T		
1899911101	REVOLV® COIL UNIVERSAL DRAIN PAN			

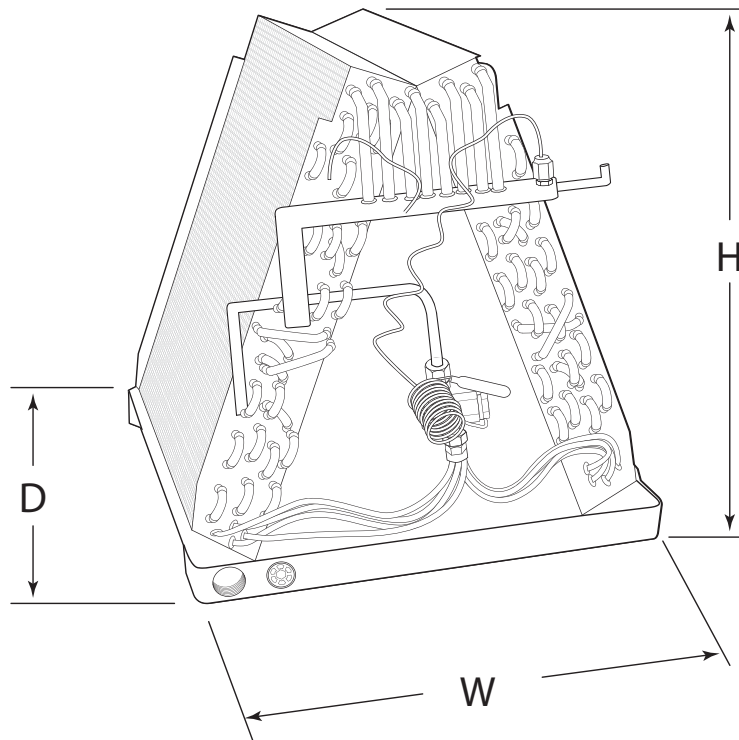



# R410A AccuCharge® "M" Series Manufactured Housing Coils

The **Revolv® R410A Coil** series is designed to be "THE" A-COIL choice to be installed on new and existing down flow MH furnaces. Revolv® AccuCharge® Coils are designed to work with AccuCharge® condensers. Compatible with A/C and H/P installations and with all standard mobile home furnaces.



## Key Features

- A** Mounted TXV sensor bulb
- B** AccuCharge® with FitRight® fittings
- C** Factory installed TXV valve suitable for A/C or H/P applications
- D** Coil has built-in strainer for coil protection
- E** UL® listed and leak tested to 500 p.s.i. Code approved 2-opening drain pan
- F** Dry-type pan does not maintain standing water
- G** Kit contains drain hose, fittings, and furnace cover plates for gas/oil furnace

**Assembled  
in the U.S.A.** 

# Revolv® R410A AccuCharge® "M" Series Manufactured Housing Coils

Revolv® R410A AccuCharge® "M" Series Manufactured Coils				
Part Number	Description	No. of Rows*	Face Area (ft <sup>2</sup> )	H x W x D
1836M4A	COIL-REVOLV® QC R410A A/C H/P	3	4.00	18" x 18" x 19 5/8"
1845M4A	COIL-REVOLV® QC R410A A/C H/P	3	5.83	24 1/2" x 18" x 19 1/2"
1847M4A	COIL-REVOLV® QC R410A A/C H/P	4	4.89	22 1/2" x 18" x 19 5/8"
187848MA	COIL-REVOLV® QC R410A A/C H/P	4	4.54	19 1/2" x 18" x 19 5/8"
* NOTE: REFER TO AHRI LISTINGS FOR ACTUAL APPLICATIONS AND CAPACITIES				
Revolv® R410A Manufactured Coil Accessories				
18R72DB0003	TXV KIT R410A REVOLV®	1.5-3.0T		
18R72DB0004	TXV KIT R410A REVOLV®	2.5-5.0T		
1899911101	REVOLV® COIL UNIVERSAL DRAIN PAN			

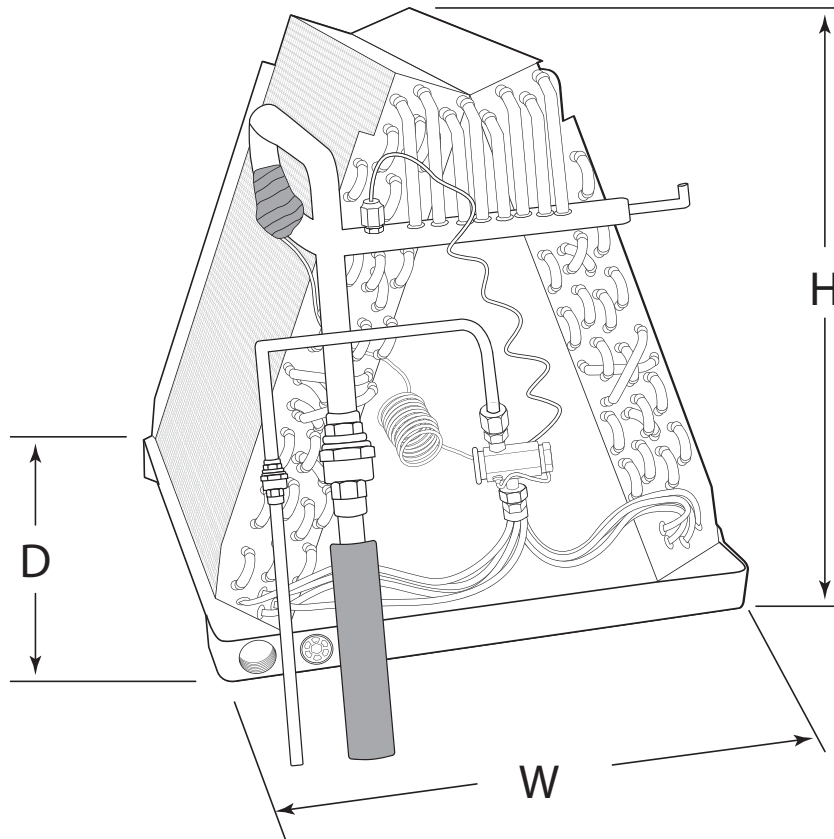



# Revolv<sup>®</sup> Service Coils

The **Revolv<sup>®</sup> Service Coils** are sold exclusively to replace coils already placed into service in an existing A/C system. Three NEW Tube in Fin Service Coils are Available in Sweat Fit models and designed for replacement of "A" coils on existing systems using a piston metering device. Easy installation Service Coils fit in most manufactured homes furnaces. TXV valve available separately.

**Revolv<sup>®</sup> Service Coils** carry a limited 30 Day Warranty from the date of installation.\*

\*CLAIMS MUST BE RECEIVED WITHIN ONE (1) YEAR FROM MANUFACTURE DATE. ALL CLAIMS MUST SHOW PROOF OF PURCHASE.

***Servicing your A/C System has never been easier with our new selection of service coils designed specifically for Mobile and Manufactured Homes!***



- Three NEW Tube in Fin Service Coils
- Available in Sweat Fit models and designed for replacement of "A" coils on existing systems
- Uses a Piston Metering Device
- For easy installation Service Coils fit in most manufactured homes furnaces
- TXV valve available separately

## Service Coils are...

an arrangement of refrigerant-to air heat transfer coils... with an expansion device and **sold exclusively to replace a coil that has already been placed into service.**

**Service coils cannot be installed in a new air handler.**

# Revolv<sup>®</sup> Service Coils

MH Service Coils						
Service Coil Model Number	Number of Tube Rows	Face area (square feet)	Piston Size	Dimensions		
				Width"	Depth"	Height"
MHSC200T	3	3.11	.061	18"	19 <sup>5</sup> / <sub>8</sub> "	14"
MHSC300T	3	4.00	.068	18"	19 <sup>5</sup> / <sub>8</sub> "	18"
MHSC400T	4	4.00	.073	18"	19 <sup>5</sup> / <sub>8</sub> "	18 <sup>1</sup> / <sub>2</sub> "

## Choosing Your New Service Coil

- 1** Measure the height of the coil being replaced—choose the service coil with the nearest height to the coil you are replacing. **NOTE:** Be certain new coil has at least the same face area as the original coil.
- 2** Count the number of rows of tubes in one side of the coil (normally 2, 3, or 4 rows). Choose the coil with the same number of rows as the coil being replaced.
- 3** Use the correct metering device—the service coil is shipped with a typical piston for the coil. The metering device must be determined by the installing contractor. Normally this means removing the piston or metering device from the old coil and installing it in the new service coil. The contractor should, if possible, consult the condenser data to ensure correct metering device for the installation. Installation instructions are included with each coil.

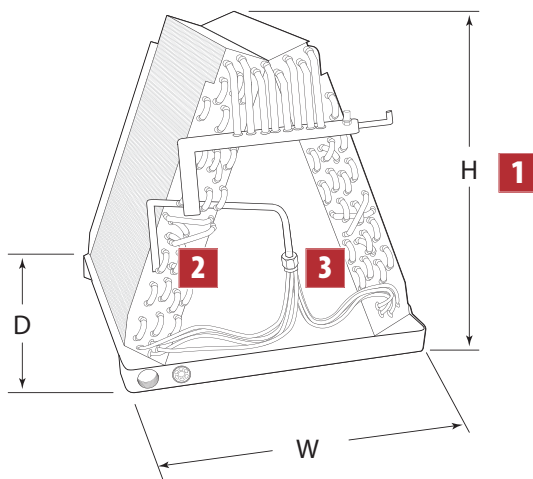

### NOTICE

All Service Coils are shipped from the factory pressurized with Nitrogen.

**These coils do not contain any refrigerant.**

**Relieve Nitrogen pressure before opening the refrigerant circuit.**



# MANUFACTURED HOUSING AC ACCESSORIES

THERMOSTATS		
PART NUMBER	DESCRIPTION	Weight Lbs.
02538747000	THERMOSTAT-HEATING / COOLING—4 WIRE PIGTAIL	1
111001	THERMOSTAT-COOL ONLY	1
111002	THERMOSTAT-HEAT ONLY	1
111003	THERMOSTAT-HEATING / COOLING 5 WIRE	1
111004	THERMOSTAT-DIGITAL PROGRAMMABLE HEAT PUMP (2H1C)	1
111005	THERMOSTAT-DIGITAL NON PROGRAMMABLE HEAT PUMP (2H1C)	1
111006	THERMOSTAT-DIGITAL PROGRAMMABLE AC (1H1C)	1
111007	THERMOSTAT-DIGITAL NON PROGRAMMABLE AC (1H1C)	1
111010	THERMOSTAT-DIGITAL MULTIFUNCTION	1

**THERMOSTAT**



111001

**THERMOSTAT**



111002

**THERMOSTAT**



111003

**THERMOSTAT**



111004

**THERMOSTAT**



111005

**THERMOSTAT**



111006

**THERMOSTAT**



111007

**THERMOSTAT**



111010

**THERMOSTAT**



02538747000



# MANUFACTURED HOUSING AC ACCESSORIES

## FOR ALL NORDYNE FURNACE APPLICATIONS (INTERTHERM/MILLER)

PART NUMBER	DESCRIPTION	WEIGHT LBS.
9536.7411	COIL CABINET W/ FILTER	6
13010001	COIL CABINET E2/E3 —KD	6
13010002	COIL CABINET- LOUVERED GRILLE ONLY	4

### COIL CABINET

- UTILIZES NORDYNE FRONT GRILLE
- SHIPS FLAT-REDUCED FREIGHT EASY ASSEMBLY
- 23" HEIGHT-MAXIMUM ALLOWED WITH GRILLE
- USES STANDARD 20" x 25" x 1" FILTER



13010001 COIL CABINET E2-E4-KD

### LOUVERED GRILLE

Replacement for Coil Cabinet



13010002 COIL GRILLE E2-E4-KD

## BLOWERS AND ADAPTORS FOR OLDER REVOLV® FURNACES

PART NUMBER	DESCRIPTION
3500.6901	BLOWER-REVOLV® ELECTRIC 2-4 TONS
3500.7901	BLOWER-REVOLV® ELECTRIC 4+ TONS
7900.6051	BLOWER-REVOLV® GAS DGAT, 76-7900 ONLY 4 TON AC
7900.6061	BLOWER-REVOLV® GAS DGAT, 76-7900 ONLY 3.5 TON AC
7900.7741	BLOWER-REVOLV® GAS DGAA, DGAH-4 TON
7900.7751	BLOWER-REVOLV® GAS DGAA, DGAH-5 TON

## BLOWERS AND ADAPTORS FOR OLDER NORDYNE FURNACES

PART NUMBER	DESCRIPTION
9536.7301	BLOWER-NORDYNE ELECTRIC ALL FEXX SERIES, E1EH
9536.7351	BLOWER-NORDYNE ELECTRIC E2EH ONLY
1888120854D	BLOWER-NORDYNE ELECTRIC E2EH-E2EB 4-4.5 TON
9336.7901	BLOWER-NORDYNE GAS M1G-M1S SERIES-2-4.0 TON
9536.7301	BLOWER ELECTRIC A/C

# MANUFACTURED HOUSING AC ACCESSORIES

DUAL FUEL KIT	
PART NUMBER	DESCRIPTION
13010004	DUAL FUEL KIT
	

CONTROL BOXES FOR OLDER FURNACES ( COLEMAN <sup>®</sup> , EVCON <sup>™</sup> , RED T <sup>™</sup> )	
Part Number	Description
3500.5821	CONTROL PACKAGE FOR ADDING AC/HP W/2 WIRE (HEAT ONLY) T/STAT TO 3400, 3500, AND EBXXA FURNACES
3500.5841	CONTROL PACKAGE FOR ADDING AC/HP W/4 WIRE (HEAT/COOL) T/STAT TO 3400, 3500, AND EBXXA FURNACES
7900.6021	CONTROL PACKAGE FOR ADDING AC/HP W/2 WIRE (HEAT ONLY) T/STAT TO OLDER (PRE 1996) GAS FURNACES
18400001	CONTROL PACKAGE FOR ADDING AC/HP W/4 WIRE T/STAT (HEAT/COOL) TO OLDER (PRE 1996) GAS FURNACES



# Packaged Air Conditioners

The Revolv® single packaged air conditioners are high efficiency self contained cooling and heating units that can be installed on a slab. Units are ETL and ETLc listed.

## Features and Benefits

**Quality Compressor** – State of the art compressor is standard equipment.

**Hi Pressure Switch** – Ensure long compressor life.

**Micro-Channel Coils** – Both indoor and outdoor all aluminum coils are designed to optimize heat transfer, minimize size and cost, and increase durability and reliability. Eliminates corrosion.

**ECM Blower Motor** – Fixed torque energy efficient brushless DC ECM motor.

**Permanently Lubricated Condenser Motor** – A heavy duty PSC motor for long lasting reliability and quiet operation. Requires no maintenance and is completely protected from rain and snow.

**Designed Using Galvanized Steel** – With a polyester urethane coat finish. The 950 hour salt spray finish is 1.5 mil thick and resists corrosion 50% better than comparable units.

**Compact Footprint and Profile** – Make the RPC Series easy to install and transport.

**Optional Electric Heat** – Field installed 5 – 15 KW.

## Warranty

**10 Years Parts / 1 Year Labor**

Visit [www.stylecrestinc.com](http://www.stylecrestinc.com) for warranty registration



# 14 SEER



## Revolv® Packaged Air Conditioners

REVOLV® PACKAGED AIR CONDITIONERS 14 SEER				
Tons Nominal	Unit SKU	AHRI Model #	Cooling BTUH	Unit Size W x L x H
1.5	RPC1418	RP7RE-018K	17800	35" x 49" x 22.2"
2	RPC1424	RP7RE-024K	23800	35" x 49" x 22.2"
2.5	RPC1430	RP7RE-030K	28400	35" x 49" x 22.2"
3	RPC1436	RP7RE-036K	35000	35" x 49" x 22.2"
3.5	RPC1442	RP7RE-042K	40500	35" x 49" x 30.2"
4	RPC1448	RP7RE-048K	47000	35" x 49" x 30.2"
5	RPC1460	RP7RE-060K	56000	35" x 49" x 34.2"

HEAT STRIP KITS	
KW	SKU
5	H3HK005H-01C
10	H3HK010H-01C
15	H3HK015H-01C

ACCESSORIES	
4-Pole Single Circuit Adapter	913350
6-Pole Single Circuit Adapter	913556
Circuit Breaker Single Phase (2-Pole)	913554
Duct Collar (12")	294941A
Duct Collar (14")	294942A

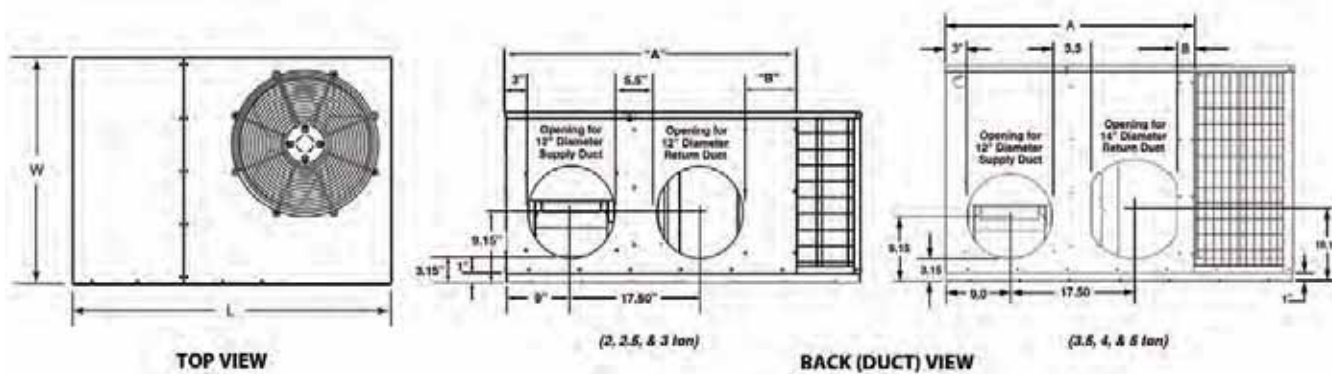

REVOLV® PACKAGED AIR CONDITIONER DIMENSIONS					
Unit SKU	(L) Length	(W) Width	(H) Height	A	B
RPC1418	49"	35"	22.2"	35.02"	2.48"
RPC1424	49"	35"	22.2"	35.02"	2.48"
RPC1430	49"	35"	22.2"	35.02"	2.48"
RPC1436	49"	35"	22.2"	35.02"	2.48"
RPC1442	49"	35"	30.2"	35.02"	2.48"
RPC1448	49"	35"	30.2"	35.02"	2.48"
RPC1460	49"	35"	34.2"	35.02"	2.48"



# Packaged Heat Pumps

The Revolv® single packaged heat pumps are high efficiency self contained cooling and heating units that can be installed on a slab. Units are ETL and ETLc listed.

## Features and Benefits

**Quality Compressor** – State of the art compressor is standard equipment.

**Hi / Low Pressure Switches** – Ensure long compressor life.

**Micro-Channel Coils** – Both indoor and outdoor all aluminum coils are designed to optimize heat transfer, minimize size and cost, and increase durability and reliability. Eliminates corrosion.

**ECM Blower Motor** – Fixed torque energy efficient brushless DC ECM motor.

**Permanently Lubricated Condenser Motor** – A heavy duty PSC motor for long lasting reliability and quiet operation. Requires no maintenance and is completely protected from rain and snow.

**Compact Footprint and Profile** – Make the RPH Series easy to install and transport.

**First in Industry Patented Hot Gas Defrost** – Ensures complete, worry-free defrost.

**All Aluminum Coils** – Provides high corrosion resistance, lower refrigerant volume.

**Five Minute Restart Time Delay** – When the unit shuts down, a five minute delay keeps the unit from restarting, eliminating the highest cause of compressor failure.

**Outdoor Thermostat** – Standard

**Optional Electric Heat** – Field installed 5-15 KW

## Warranty

**10 Years Parts / 1 Year Labor**

Visit [www.stylecrestinc.com](http://www.stylecrestinc.com) for warranty registration



# 14 SEER



# Revolv® Packaged Heat Pumps

REVOLV® PACKAGED HEAT PUMPS 14 SEER					
Tons Nominal	Unit SKU	AHRI Model #	Cooling BTUH	Heating BTUH (47°F)	Unit Size W x L x H
2	RPH1424	RQ7RE-024K	23200	21800	35" x 49" x 30.2"
2.5	RPH1430	RQ7RE-030K	28200	27400	35" x 49" x 30.2"
3	RPH1436	RQ7RE-036K	35000	34600	35" x 49" x 30.2"
3.5	RPH1442	RQ7RE-042K	41300	39000	35" x 49" x 30.2"
4	RPH1448	RQ7RE-048K	48000	48000	35" x 63" x 38.2"
5	RPH1460	RQ7RE-060K	55500	56000	35" x 63" x 38.2"

HEAT STRIP KITS	
KW	SKU
5	H3HK005H-01C
10	H3HK010H-01C
15	H3HK015H-01C

ACCESSORIES	
4-Pole Single Circuit Adapter	913350
6-Pole Single Circuit Adapter	913556
Circuit Breaker Single Phase (2-Pole)	913554
Duct Collar (12")	294941A
Duct Collar (14")	294942A

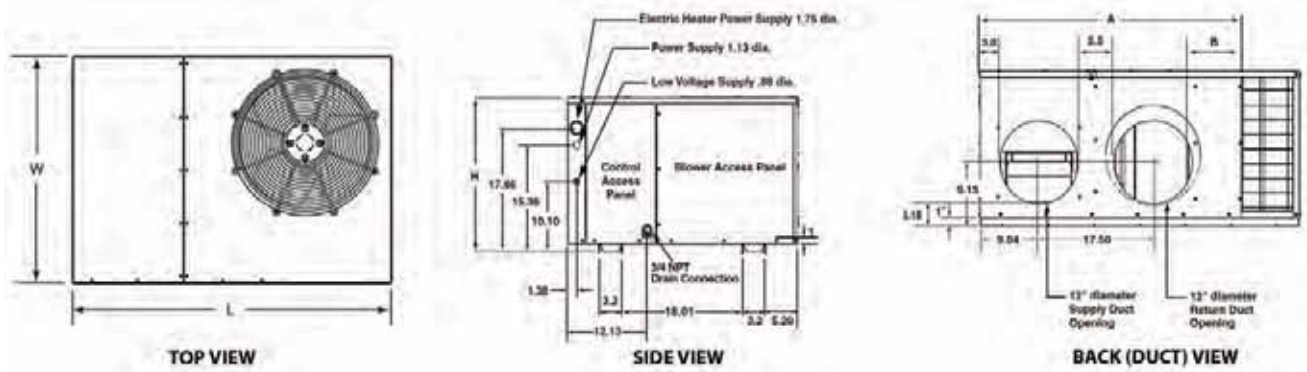

REVOLV® PACKAGED HEAT PUMP DIMENSIONS					
Unit SKU	(L) Length	(W) Width	(H) Height	A	B
RPH1424	49"	35"	30.2"	35.02"	2.48"
RPH1430	49"	35"	30.2"	35.02"	2.48"
RPH1436	49"	35"	30.2"	35.02"	2.48"
RPH1442	49"	35"	30.2"	35.02"	2.48"
RPH1448	63"	35"	38.2"	35.02"	2.48"
RPH1460	63"	35"	38.2"	35.02"	2.48"



# PACKAGED SYSTEMS ACCESSORIES

## SINGLE WIDE KIT FOR SELF CONTAINED AIR CONDITIONERS (TYPICAL)

**ORDER ONE EACH OF THE FOLLOWING:**

- 112012 ACCESSORY KIT  
CONSISTS OF: 12" x 20" RETURN BOX & GRILLE  
BLUE WASHABLE RETURN AIR FILTER  
12" x 12" SUPPLY FITTING W/DAMPER

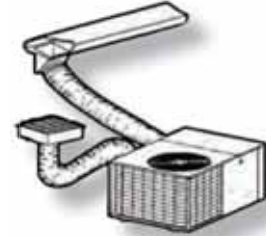

## DOUBLE WIDE KIT FOR SELF CONTAINED AIR CONDITIONERS (TYPICAL)

**ORDER ONE EACH OF THE FOLLOWING:**

- 112012 ACCESSORY KIT (SEE SINGLE WIDE FOR INCLUDED ITEMS)
- 1101225 12" x 25' FLEX DUCT .047 R4
- 11121212 12" x 12" x 12" METAL WYE
- 7336.5801 DUCT CONNECTOR W/ DAMPER (1 REQUIRED FOR INSTALL)



### SUPPLY / RETURN

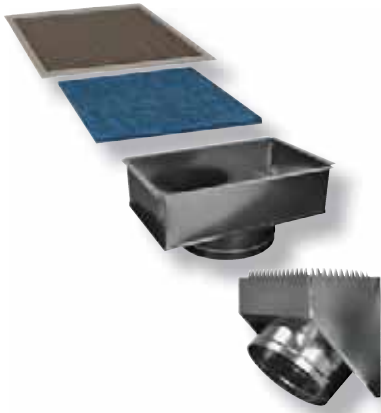

- 112012 ACCESSORY KIT  
12" SUPPLY, 12" RETURN

### RETURN AIR KIT W/GRILLE



- 115012 12" RETURN AIR KIT W/GRILLE
- 115014 14" RETURN AIR KIT W/GRILLE
- 111220BRN GRILLE ONLY

### FLEX DUCT



- 1101025 10" x 25' FLEX DUCT R4.2
- 1101225 12" x 25' FLEX DUCT R4.2
- 1101425 14" x 25' FLEX DUCT R4.2
- 1161025 10" x 25' FLEX DUCT R6
- 1161225 12" x 25' FLEX DUCT R6
- 1161425 14" x 25' FLEX DUCT R6
- 1181225 12" x 25' FLEX DUCT R8
- 1181425 14" x 25' FLEX DUCT R8

**METAL WYE**



- 11121010 12" x 10" x 10" METAL WYE
- 11121212 12" x 12" x 12" METAL WYE
- 111412 14" x 12" x 12" METAL WYE
- 11141414 14" x 14" x 14" METAL WYE

**REDUCER INCREASER**



- 1112108 REDUCER INCREASER 12"-10"
- 1114128 REDUCER INCREASER 14"-12"

**DUCT COLLAR W/TABS**



- 110010 10" COLLAR W/TABS
- 110120 12" COLLAR W/TABS
- 110140 14" COLLAR W/TABS

**DRAWBANDS**



- 110225 DRAWBAND 36" LENGTH FOR FLEX DUCT / 50 PKG
- 110248 DRAWBAND 48" LENGTH FOR FLEX DUCT / 50 PKG

**PIPE HANGER STRAP**



- 1113038 PLASTIC, 3/4" x 100', .050 GAUGE ROLL

**PIPE HANGER STRAP**



- 116507 GALVANIZED 3/4" x 100' 28 GAUGE ROLL

**FABRIC FLEX DUCT STRAP**



- 6014932 1 3/4" x 300' / FABRIC

**BACKFLOW DAMPER FOR RE, RG, & M5 SERIES**



- 901083 PKG. AC BACKFLOW DAMPER GAS/OIL FURNACE

**BACKFLOW DAMPER FOR RE, RG, & M5 SERIES**



- 902095 PKG. AC BACKFLOW DAMPER GAS/OIL FURNACE



# RE9 Series Electric Furnaces

The RE Series furnace is designed for all sizes of manufactured and modular homes. These units incorporate reliability and low maintenance. Units may be installed free standing in a utility room or enclosed in an alcove or closet. RE Series furnaces are A/C ready, with multiple blower combinations for cooling requirement.

## Features and Benefits

**A/C and H/P ready** – For up through 4.0 tons.

**Available in** – Downflow and Upflow configurations.

**Built in full sized coil cabinet** – No need to add parts.

**Built in circuit breakers** – For safety and dependability.

**Nichrome heating elements** – For long lasting efficient heat.

## Warranty

**2 Years Parts / 1 Year Labor**

Visit [www.stylecrestinc.com](http://www.stylecrestinc.com)  
for warranty registration



# Revolv® RE9 Series Electric Furnaces

REVOLV® RE9 SERIES ELECTRIC FURNACE	
Model Number	Description
RE9D10C4	ELECTRIC 10KW DOWNFLOW W/CABINET
RE9D12C4	ELECTRIC 12KW DOWNFLOW W/CABINET
RE9D15C4	ELECTRIC 15KW DOWNFLOW W/CABINET
RE9D17C4	ELECTRIC 17KW DOWNFLOW W/CABINET
RE9D20C4	ELECTRIC 20KW DOWNFLOW W/CABINET
RE9D23C4	ELECTRIC 23KW DOWNFLOW W/CABINET
RE9U10C4	ELECTRIC 10KW UPFLOW W/CABINET
RE9U12C4	ELECTRIC 12KW UPFLOW W/CABINET
RE9U15C4	ELECTRIC 15KW UPFLOW W/CABINET
RE9U17C4	ELECTRIC 17KW UPFLOW W/CABINET
RE9U20C4	ELECTRIC 20KW UPFLOW W/CABINET
RE9U23C4	ELECTRIC 23KW UPFLOW W/CABINET

Electrical Specifications				
Model Number	Supply Circuit	Total Amperes	Maximum Over-current Rating	Minimum Circuit Ampacity
RE9D/U10C4	Single	44.6	60	56
RE9D/U12C4	Single	51.2	70	64
	Dual "A"	27.1	40	34
RE9D/U15C4	Dual "B"	24.2	30	30
	Single	65.4	90	82
	Dual "A"	44.6	60	56
RE9D/U17C4	Dual "B"	20.8	30	26
	Single	70.4	90	88
	Dual "A"	47.9	60	60
RE9D/U20C4	Dual "B"	22.5	30	28
	Single	86.2	125	108
	Dual "A"	44.6	60	56
RE9D/U23C4	Dual "B"	41.7	60	52
	Single	93.8	125	117
	Dual "A"	45.5	60	57
RE9D/U23C4	Dual "B"	48.0	60	60

Revolv® RE9 Series Electric Furnace						
Electric Furnace Models	RE9D/U10C4	RE9D/U12C4	RE9D/U15C4	RE9D/U17C4	RE9D/U20C4	RE9D/U23C4
Rated Heating Output, Btuh (see note 1)	35,000	41,000	53,000	57,000	70,000	75,000
Watts (Total kw, Heating Elements and Blower)	10.4	12.0	15.4	16.6	20.4	22.0
Supply Voltage	240 Volts/60Hz/1-Phase					
Heating Elements, No.(Total kw)	2 (10.0)	2 (11.6)	3 (15.0)	3 (16.2)	4 (20.0)	4 (21.6)
Blower Wheel Size	10 ½" Dia, 8" Wide					
Motor Speed, H.P. Rating, Amps	4 Speed, ½ HP, 2.9					
Test ESP, in. w.c. Max	0.3					
Optional Cooling Available with factory installed blower	2.0 - 4.0 Ton					
Optional Heat Pump Available with factory installed blower	2.0 - 4.0 Ton					
Air Filter (U-Models)	16" x 20" x 1" (nominal)					
Air Filters (D-Models)	18" x 30" x 1" (front)			16" x 20" x 1" (top)		
Furnace Dimensions	Width-20", Height-60.63", Depth-24 ½"					
1. Heating output rated at listed voltage. For outputs at voltages other than 240V, multiply BTU/H rating by the following factors: x 0.92 (230V), x 0.84 (220V), x 0.75 (208V)						

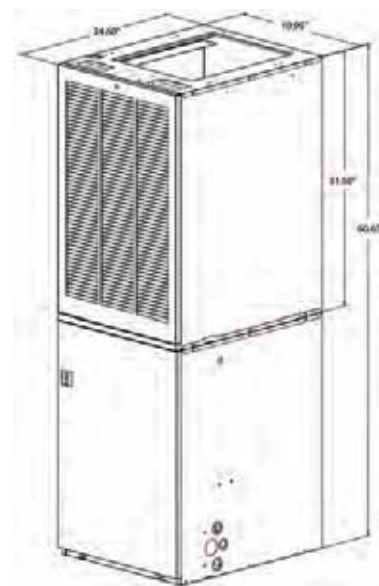

Clearances		
ALL MODELS	CLOSET	ALCOVE
Front ‡	6"	18"
Back	0"	0"
Sides	0"†	0"†
Top	0"	0"
Top and Sides of Duct	0"	0"
Bottom of Duct	0"	0"
‡ Service Clearance		
† For upflow application using upflow stand, 1" minimum per side.		

Revolv® RE9 Accessories	
Part Number	Description
1007729	ECM Blower Kit
902985	Blower - 5 ton
902989	Top Grille / Frame
903891	Coil Cabinet Downflow (Front Return)
904620A	Upflow Stand
281241R	Replacement Door for Upflow Stand
1006730	Coil Cabinet Upflow & Downflow w/Solid Door
1006731	Coil Cabinet Upflow & Downflow w/Louvered Door



# RE9X Series Electric Furnaces

The RE Series furnace is designed for all sizes of manufactured and modular homes. These units incorporate reliability and low maintenance. Units may be installed free standing in a utility room or enclosed in an alcove or closet. RE Series furnaces are A/C ready, with multiple blower combinations for cooling requirement.

## Features and Benefits

- A/C and H/P ready** – For up through 4.0 tons.
- Convertible to** – Downflow and Upflow configurations.
- Built in circuit breakers** – For safety and dependability.
- Nichrome heating elements** – For long lasting efficient heat.
- Available** – Full sized Upflow and Downflow coil cabinets.

## Warranty

**2 Years Parts / 1 Year Labor**

Visit [www.stylecrestinc.com](http://www.stylecrestinc.com) for warranty registration

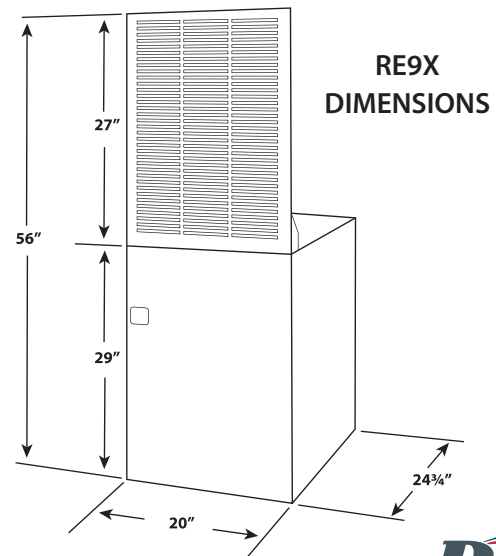

# Revolv® RE9X Series Electric Furnaces

Furnace Model Number	Description	Depth (D)	Width (W)	Height <sup>^</sup> (H)	Total KW	No. of Elements (Total KW)	BTUH*	Voltage 1-Phase
RE9X10N4	ELECTRIC 10KW W/O CABINET	24 3/4"	20"	29"	10.4	2 (10.0)	35000	240V/60Hz
RE9X12N4	ELECTRIC 12KW W/O CABINET	24 3/4"	20"	29"	12.0	2 (11.6)	41000	240V/60Hz
RE9X15N4	ELECTRIC 15KW W/O CABINET	24 3/4"	20"	29"	15.4	3 (15.0)	53000	240V/60Hz
RE9X17N4	ELECTRIC 17KW W/O CABINET	24 3/4"	20"	29"	16.6	3 (16.2)	57000	240V/60Hz
RE9X20N4	ELECTRIC 20KW W/O CABINET	24 3/4"	20"	29"	20.4	4 (20.0)	70000	240V/60Hz
RE9X23N4	ELECTRIC 23KW W/O CABINET	24 3/4"	20"	29"	22.0	4 (21.6)	75000	240V/60Hz

INFORMATION FOR ALL MODELS				CLEARANCES			
Blower Wheel Size		10.5" Diameter, 8" Wide		CLOSET		ALCOVE	
Motor Speed H. P. Rating, Amps		4 Speed, 1/2 HP, 2.9		Front ‡		6" 18"	
Test ESP, in W. C. Max		0.3		Back		0" 0"	
Optional Cooling Available with Factory Installed Blower		2.0 - 4.0 Ton		Sides		0" † 0" †	
Optional Heap Pump Available with Factory Installed Blower		2.0 - 4.0 Ton		Top		0" 0"	
Air Filter - Standard		16" x 20" x 1" Nominal		Top & Sides of Duct		0" 0"	
* Heating output rated at listed voltage. For outputs at voltages other than 240V, multiply BTUH rating by the following factors: x 0.92 (230V), x 0.84 (220V), x 0.75 (208V) ^ Height is 56" with return air grille installed, 58" with coil cabinet, and 72" with coil cabinet and upflow stand.				Bottom of Duct		0" 0"	
				‡ Service Clearance		† for Upflow application using upflow stand 1" minimum per side	

Revolv® RE9X Series Electrical Specifications				
Model Number	Supply Circuit	Total Amperes	Maximum Over-current Rating	Minimum Circuit Ampacity
RE9X10N4	Single	44.6	60	56
RE9X12N4	Single	51.2	70	64
	Dual "A"	27.1	40	34
	Dual "B"	24.2	30	30
RE9X15N4	Single	65.4	90	82
	Dual "A"	44.6	60	56
	Dual "B"	20.8	30	26
RE9X17N4	Single	70.4	90	88
	Dual "A"	47.9	60	60
	Dual "B"	22.5	30	28
RE9X20N4	Single	86.2	125	108
	Dual "A"	44.6	60	56
	Dual "B"	41.7	60	52
RE9X23N4	Single	93.8	125	117
	Dual "A"	45.5	60	57
	Dual "B"	48.0	60	60

Revolv® RE9X Airflow Data									
RE9X10N4, RE9X12N4, RE9X15N4, RE9X17N4, RE9X20N4, RE9X23N4									
Coil	High		Med. High		Med. Low		Low		
	4 Ton	No Coil	3.5 Ton	No Coil	3 Ton	No Coil	2.5 Ton	No Coil	
Static (ESP) in W.C.	0.1	1559	1503	1389	1362	1227	1203	923	885
	0.2	1506	1458	1352	1330	1208	1174	906	863
	0.3	1460	1414	1310	1291	1170	1146	880	831
	0.4	1401	1352	1260	1241	1136	1103	845	798
	0.5	1333	1282	1198	1179	1086	1055	805	758
	0.6	1251	1208	1133	1113	1027	996	757	707

Revolv® RE9X Accessories	
Part Number	Description
1007729	ECM Blower Kit
902985	Blower - 5 ton
902989	Top Grille / Frame
903891	Coil Cabinet Downflow (Front Return)
904620A	Upflow Stand
281241R	Replacement Door for Upflow Stand
1006730	Coil Cabinet Upflow & Downflow w/Solid Door
1006731	Coil Cabinet Upflow & Downflow w/Louvered Door



# RG1 80% AFUE Gas Furnaces

The RG1 Series furnace is designed for all sizes of manufactured and modular homes. These units incorporate high efficiency, reliability, and low maintenance. Units may be installed free standing in a utility room or enclosed in an alcove or closet. RG1 Series furnaces are available in A/C adaptable or A/C ready, with or without coil cavity box, multiple blower combinations for cooling requirements, and many burner options. Units are ETL and ETLc listed.

## Features and Benefits

**Sealed combustion** – Vents exhaust gases directly outdoors and draws in outside fresh air for combustion.

**Choice of models** – For up to 4 tons A/C and 3.5 tons H/P.

**Modern hot surface ignition** – No pilot lights to blow out.

**Low maintenance** – Sealed bearings on motors, reliable controls and burners.

**Appliance quality** – Metal door with baked enamel finish for long life and easy cleaning.

## Warranty

**2 Years Parts / 1 Year Labor**

**10 Years Heat Exchanger**

Visit [www.stylecrestinc.com](http://www.stylecrestinc.com)  
for warranty registration



# Revolv® RG1 AFUE 80% Gas Furnaces

REVOLV® RG1 80% AFUE GAS FURNACES		
Model Number	Description	Shipping Weight Lbs
RG1D56N3	GAS-80%, DOWNFLOW, 56KBTU NO CABINET, 3 TON BLOWER*	152
RG1D70N3	GAS-80%, DOWNFLOW, 70KBTU NO CABINET, 3 TON BLOWER*	153
RG1D77N3	GAS-80%, DOWNFLOW, 77KBTU NO CABINET, 3 TON BLOWER*	149
RG1D90N3	GAS-80%, DOWNFLOW, 90KBTU NO CABINET, 3 TON BLOWER*	151
RG1D56C3	GAS-80%, DOWNFLOW, 56KBTU W/CABINET, 3 TON BLOWER	167
RG1D70C3	GAS-80%, DOWNFLOW, 70KBTU W/CABINET, 3 TON BLOWER	168
RG1D77C3	GAS-80%, DOWNFLOW, 77KBTU W/CABINET, 3 TON BLOWER	164
RG1D90C3	GAS-80%, DOWNFLOW, 90KBTU W/CABINET, 3 TON BLOWER	166
RG1D56N4	GAS-80%, DOWNFLOW, 56KBTU NO CABINET, 4 TON BLOWER*	156
RG1D70N4	GAS-80%, DOWNFLOW, 70KBTU NO CABINET, 4 TON BLOWER*	157
RG1D77N4	GAS-80%, DOWNFLOW, 77KBTU NO CABINET, 4 TON BLOWER*	156
RG1D90N4	GAS-80%, DOWNFLOW, 90KBTU NO CABINET, 4 TON BLOWER*	156
RG1D56C4	GAS-80%, DOWNFLOW, 56KBTU W/CABINET, 4 TON BLOWER	171
RG1D70C4	GAS-80%, DOWNFLOW, 70KBTU W/CABINET, 4 TON BLOWER	172
RG1D77C4	GAS-80%, DOWNFLOW, 77KBTU W/CABINET, 4 TON BLOWER	171
RG1D90C4	GAS-80%, DOWNFLOW, 90KBTU W/CABINET, 4 TON BLOWER	171

\* For cooling and heat pump applications, add coil cabinet 911969A (20") or 922594 (26")

RG1 80% Gas Furnace Specifications					
Furnace Model Number	Input KBTU/H	Output KBTU/H	Orifice No. Natural Gas	Orifice No. LP	A/C Ready Tons
RG1D56(N,C)3	56	46	29	45	3
RG1D70(N,C)3	70	57	24	42	3
RG1D77(N,C)3	77	62	21	40	3
RG1D90(N,C)3	90	72	17	36	3
RG1D56(N,C)4	56	46	29	45	4
RG1D70(N,C)4	70	57	24	42	4
RG1D77(N,C)4	77	62	21	40	4
RG1D90(N,C)4	90	72	17	36	4



Coil Cabinet  
911969A (20") or 922594 (26")

Clearances		
All Models	Closet	Alcove
Front	6"	18"
Back	0"	0"
Sides	0"	0"
Roof Jack	0"	0"
Top	6"	6"
Top and Sides of Duct	0"	0"
Bottom of Duct	0"	0"
B Cabinet	0"	0"
A Cabinet (w/coil box)	0"	0"
A Cabinet (w/o coil box)	¼"	¼"

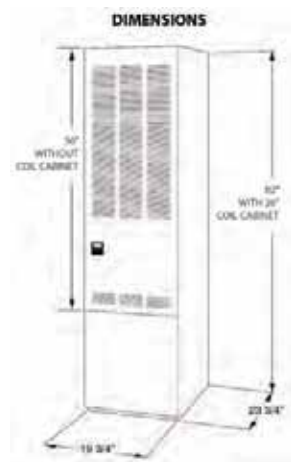
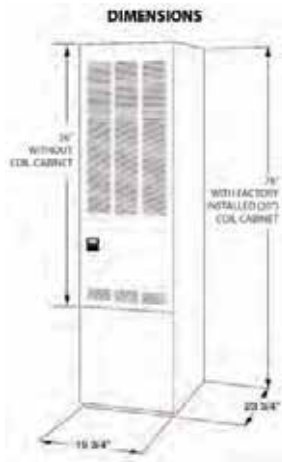





# RG7 95% + AFUE Gas Furnaces

The high efficiency downflow gas furnace is especially designed for Modular Housing. It may be installed in a utility room, or enclosed in a closet. CSA design certified for use in the United States and Canada.

## Features and Benefits

**High Efficiency** – 95% AFUE.

**Sealed combustion** – Can be vented vertically or horizontally with PVC pipe.

**Choice of models** – For A/C and H/P applications through 4 tons A/C, and 3.5 H/P

**Modern hot surface ignition** – No pilot lights to blow out.

**Multi-speed** – Direct drive blower.

**Low maintenance:** Sealed bearings on motors, reliable controls and burners.

**Appliance quality** – Metal door with baked enamel finish for long life and easy cleaning.

## Warranty

**2 Years Parts / 1 Year Labor**

**10 Years Heat Exchanger**

Visit [www.stylecrestinc.com](http://www.stylecrestinc.com)  
for warranty registration



WITH COIL CABINET



WITHOUT COIL CABINET



# Revolv® RG7 95%+ AFUE Gas Furnaces

REVOLV® RG7 95%+ GAS FURNACES		
Model Number	Description	Shipping Weight Lbs
RG7D45N4	GAS-95%, DOWNFLOW, 45KBTU, NO CABINET, 4 TON BLOWER*	150
RG7D60N4	GAS-95%, DOWNFLOW, 60KBTU, NO CABINET, 4 TON BLOWER*	150
RG7D72N4	GAS-95%, DOWNFLOW, 72KBTU, NO CABINET, 4 TON BLOWER*	155
RG7D45C4	GAS-95%, DOWNFLOW, 45KBTU, W/CABINET, 4 TON BLOWER	170
RG7D60C4	GAS-95%, DOWNFLOW, 60KBTU, W/CABINET, 4 TON BLOWER	170
RG7D72C4	GAS-95%, DOWNFLOW, 72KBTU, W/CABINET, 4 TON BLOWER	175

\*For cooling and heat pump applications, add coil cabinet 911969A (20") or 922594 (26")

**VENTING**

All models are approved for both vertical and horizontal direct (2 pipe) venting applications. See Vent Table below for specified sizes and allowable lengths.

**Maximum Direct Vent, Dual Pipe Length (ft.)\***

RG7 Inputs (BTUH)	Inlet / Outlet 3 in. Diameter	Inlet / Outlet 2 in. Diameter
45,000	60	30
60,000	60	30
72,000	60	30

\*NOTES:

1. Subtract 3.5 ft. for each additional 3" 90 degree elbow.
2. Two 45 degree elbows are equivalent to one 90 degree elbow.
3. One short radius elbow is equivalent to two long radius elbows
4. Do not include termination elbows in calculation of vent length
5. This table is applicable for elevations from sea level to 2,000 ft.  
For higher elevations decrease vent pipe lengths by 8% per 1000 ft. of altitude.
6. Only the listed pipe materials are approved for use with RG7 condensing furnaces.
7. For Canadian applications, use ULC S636 approved material.

**RG7 95% Gas Furnace Specifications**

Furnace Model Number	Input KBTU/H	Output KBTU/H	A/C Ready Tons
RG7D45N4	45	42.75	4
RG7D60N4	60	57	4
RG7D72N4	72	68.4	4
RG7D45C4	45	42.75	4
RG7D60C4	60	57	4
RG7D72C4	72	68.4	4



**Coil Cabinet**  
911969A (20") or 922594 (26")

**Clearances**

ALL MODELS	CLOSET	ALCOVE
Front	1"	1"
Back	0"	0"
Sides	0"	0"
Vent	0"	0"
Top	6"	6"
Duct (Plenum) (w/coil box)	0"	0"
Duct (Plenum) (w/o coil box) within 3 feet	¼"	¼"

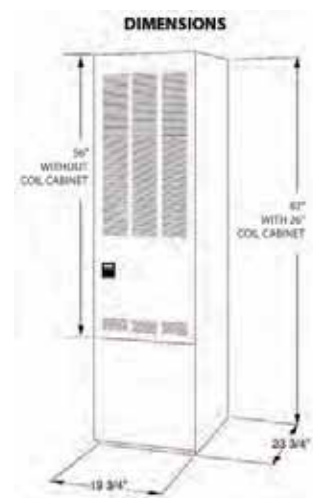
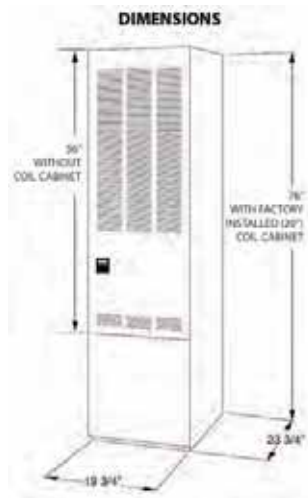



# M5 Series Oil Furnaces

The M5 oil furnace is designed for all sizes of manufactured and modular homes. These units incorporate high efficiency, reliability, and low maintenance. Units may be installed free standing in a utility room or enclosed in an alcove or closet. M5 oil furnaces are A/C ready, with coil cavity box.

## Features and Benefits

**Sealed Combustion System**—Vents exhaust gas directly outdoors and draws in 100% outside air for the burner.

**Easy Open Pawl Latch**—Secures the door firmly for transit, yet allows easy removal for access.

**Large, Effective Air Filter**—Room air is cleaner with this permanent washable filter.

**High Efficiency Drum Heat Exchanger**—Delivers optimum heat transfer with low air resistance.

**Appliance Quality Door**—Protects against rust and other corrosion. Baked enamel finish allows for easy cleaning.

**Fully Insulated Cabinet**—Insures minimized heat loss and quiet operation.

**Reliable Burner**—With uniform flame pattern extends life of heat exchanger.

## Warranty

**2 Years Parts / 1 Year Labor**

**10 Years Heat Exchanger**

Visit [www.stylecrestinc.com](http://www.stylecrestinc.com) for warranty registration



## Revolv® M5 Oil Furnaces

REVOLV® M5 OIL FURNACES			
Previous Revolv® Model Number	New Revolv® Model Number	Description	Shipping Weight Lbs
RO1D66C3	M5SB-066A BW	Oil, downflow, 66KBTU, with cabinet, 3 ton blower	167
RO1D86C3	M5SB-086A BW	Oil, downflow, 86KBTU, with cabinet, 3 ton blower	174

M5 Oil Furnace Specifications								
Previous Revolv® Model Number	New Revolv® Model Number	Input MBtu/h	Output MBtu/h	E.S.P. In. WC	Motor HP	Motor FLA	A/C Ready Tons	AFUE %
RO1D66C3	M5SB-066A BW	66	56	0.3	1/4	6	3	83
RO1D86C3	M5SB-086A BW	86	73	0.3	1/4	6	3	83

Clearances			
All Models	Closest	Alcove	
Front	6"	18"	
Back	0"	0"	
Sides	0"	0"	
Roof Jack	0"	0"	
Top	6"	6"	
Top and Sides of Duct	0"	0"	
Bottom of Duct	0"	0"	

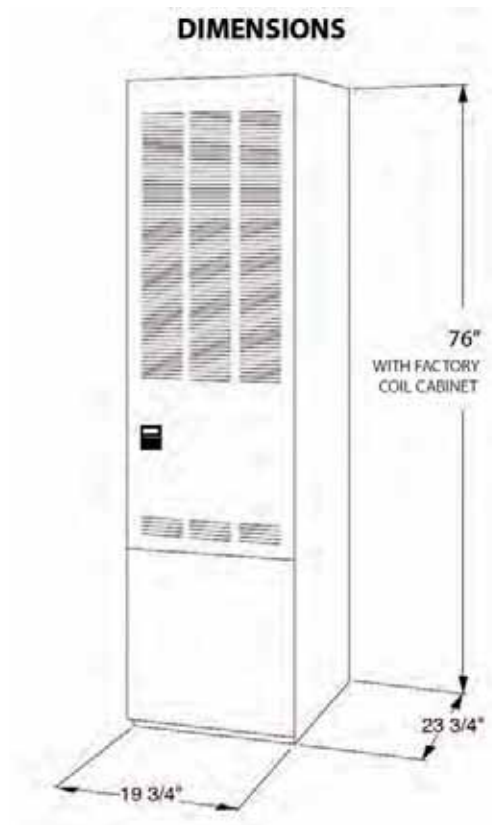

# RE9, RG1, AND M5 FURNACE ACCESSORIES

RE9, RG1 & M5 Furnace Accessories	
Description	Part Number
Automatic Cavity / Backflow Damper	901083
Automatic Cavity / Backflow Damper	902095
Ceiling Rings (2 piece adjustable)	902521
Plenum / Duct Connectors	Part Number
11.25 x 13.50 x 0.88 12 / carton	901987A
11.25 x 13.50 x 2.00 12 / carton	901988A
11.25 x 13.50 x 4.25 6 / carton	901989A
11.25 x 13.50 x 6.25 6 / carton	901990A
11.25 x 13.50 x 8.25 4 / carton	901991A
11.25 x 13.50 x 10.25 3 / carton	901992A
11.25 x 13.50 x 12.25 3 / carton	901993A
11.25 x 13.50 x 6.25 24 / carton	902681A
Roof Jack Crown Assembly	903656A
Roof Jack Extensions (RG1/M5)	Part Number
10" Int	901935
16" Int	903107
18" Ext	901937
Sloped Roof Flashings	Part Number
2 ½" in 12" - 4 / carton	903893
3" in 12" - 4 / carton	903894
4" in 12" - 2 / carton	903895
Coil Cabinets	Part Number
Coil Cabinet ( 20" )	911969A
Coil Cabinet ( 26" )	922594

Automatic Cavity / Backflow Damper



902095

Automatic Cavity / Backflow Damper



901083

Coil Cabinet  
Fits RG1, RG7 N4 Models



911969A (20") or 922594 (26")



Ceiling Rings

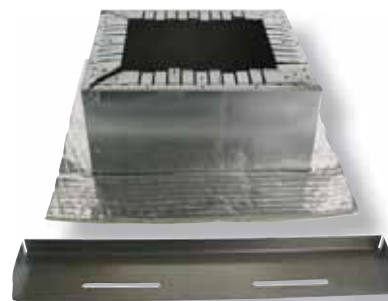

Plenum / Duct Connectors

# RE9, RG1, AND M5 FURNACE ACCESSORIES

RE9, RG1 & M5 Furnace Accessories			
Description			
Roof Jacks (RG1 / M5)	Pitch	Extension	Part Number
FAW1523-0A	0/12	15" – 23"	903658
FAW2135-0A	0/12	21" – 35"	903659
FAW2747-0A	0/12	27" – 47"	903660
SAW2135-2A	2/12	21" – 35"	903662
SAW2747-2A	2/12	27" – 47"	903663
SAW3563-2A	2/12	35" – 63"	903664
SAW5195-2A	2/12	51" – 95"	920638
SAW2747-4A	4/12	27" – 47"	903678A
SAW3563-4A	4/12	35" – 63"	903665A
SAW5195-4A	4/12	51" – 95"	903666
Roof Jack Crown Assembly			903656A
Roof Jack Extensions (RG1/M5)			Part Number
10" Int			901935
16" Int			903107
18" Ext			901937

Roof Jack Crown Assembly



Roof Jack Extensions



Roof Jack With 2 1/2 / 12 Slant Flashing

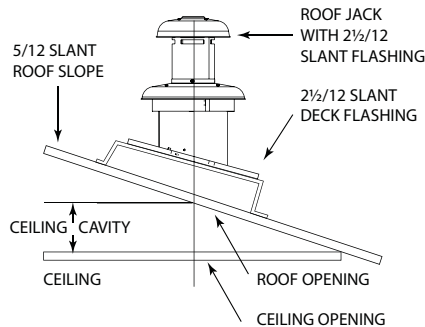

Product Availability, Prices and Specifications Subject to Change without Notice

# HEATING & AIR CONDITIONING

## RG7 FURNACE ACCESSORIES

RG7 Furnace Accessories	
Description	Part Number
Automatic Cavity / Backflow Damper	901083
Automatic Cavity / Backflow Damper	902095
Plenum / Duct Connectors	Part Number
11.25 x 13.50 x 0.88 12 / carton	901987A
11.25 x 13.50 x 2.00 12 / carton	901988A
11.25 x 13.50 x 4.25 6 / carton	901989A
11.25 x 13.50 x 6.25 6 / carton	901990A
11.25 x 13.50 x 8.25 4 / carton	901991A
11.25 x 13.50 x 10.25 3 / carton	901992A
11.25 x 13.50 x 12.25 3 / carton	901993A
11.25 x 13.50 x 6.25 24 / carton	902681A
Vent Transition RG7 - 8"	Part Number
Vent Transition RG7 - 8"	904106
Coil Cabinets	Part Number
Coil Cabinet ( 20" )	911969A
Coil Cabinet ( 26" )	922594

*Automatic Cavity / Backflow Damper*



902095

*Automatic Cavity / Backflow Damper*

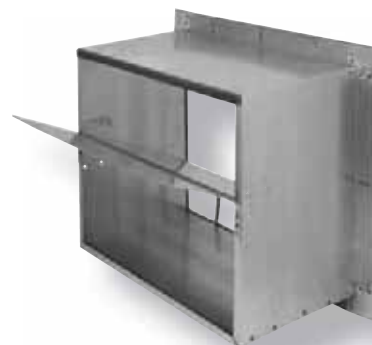

901083



*Vent Transition RG7 - 8"*

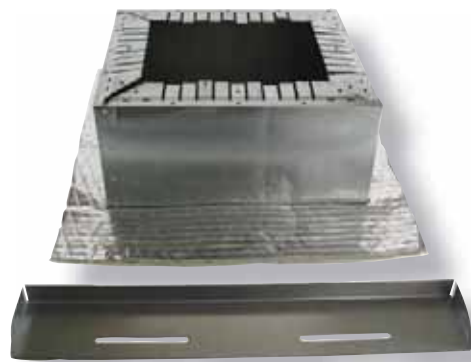

*Plenum / Duct Connectors*

# HEATING & AIR CONDITIONING

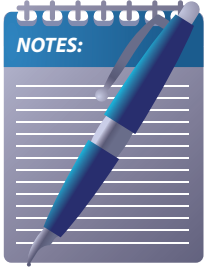

A series of horizontal blue lines spanning the width of the page, providing a space for handwritten notes. The lines are evenly spaced and extend from the left margin to the right edge of the page.





# VMC Series Gas Manufactured Housing Furnace

## Features and Benefits

- Ease of installation** – Fits standard MH furnace footprint.
- Easy conversion from natural gas to propane**–All models have convertible gas valves.
- A/C ready** – Up to 4.0 tons.\*
- 4-speed blower**–Easily adapted to air flow needs of the home.
- Limited Lifetime** – Heat exchanger warranty.
- ETL Listed**
- Sealed Combustion design** – Provides draws combustion air from the outside.
- 18-Gauge Aluminum** – Coated Primary Heat Exchanger & 24C Stainless Steel Secondary Heat Exchanger Provide Long Life on VMC.
- Standard footprint** – Easily replaces older MH furnaces
- New high capacity** – Built-in coil cabinet
- Energy Star** – Models available

\*3.5 ton on 50K BTU 4.0 ton on 75K BTU



**Warranty**  
**5 Years Parts**  
**Limited Lifetime Heat Exchanger**  
 Visit [www.stylecrestinc.com](http://www.stylecrestinc.com)  
 for warranty registration

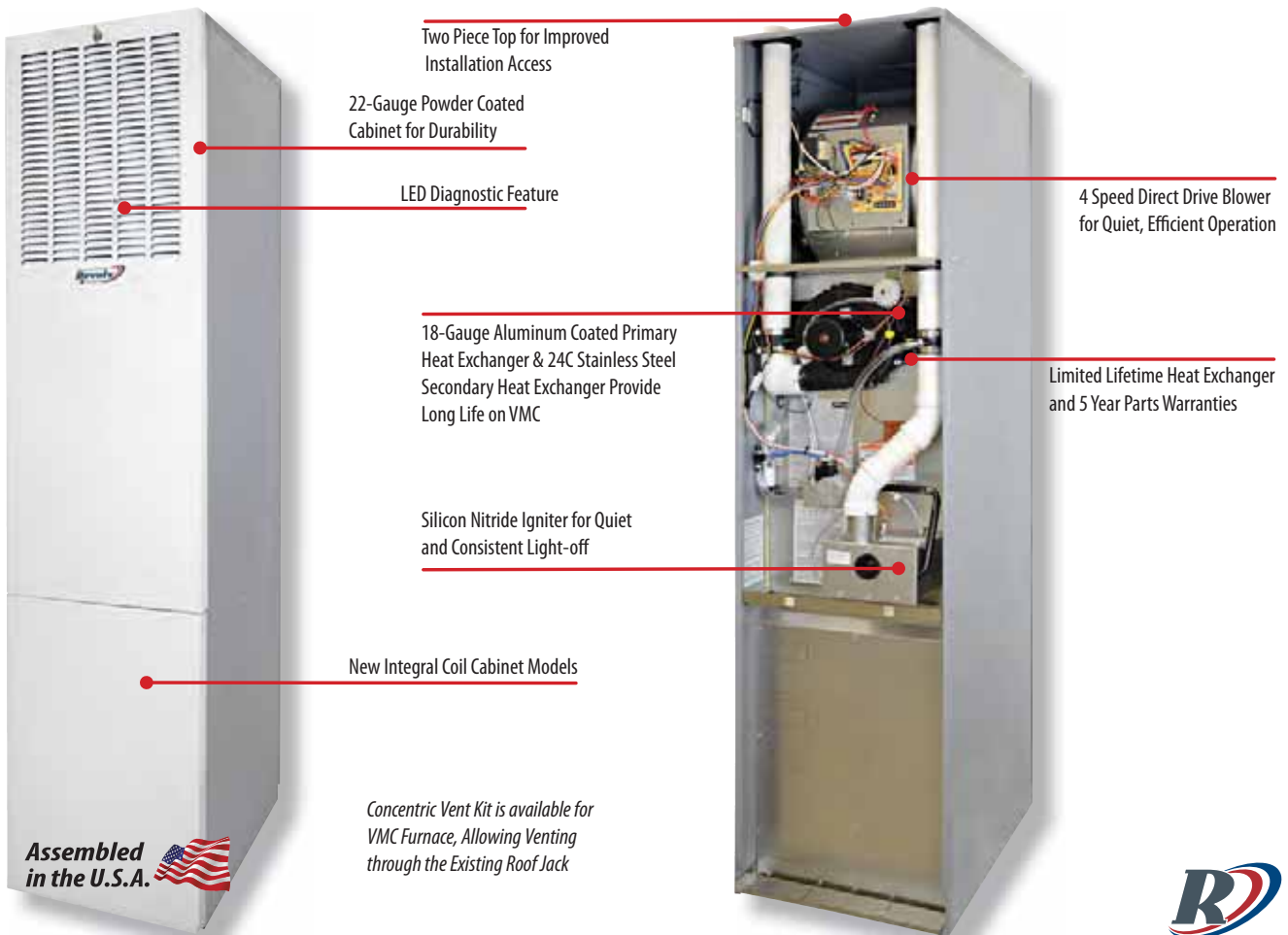

Assembled in the U.S.A.



# Revolv<sup>®</sup> VMC Series Gas Furnaces

## REVOLV<sup>®</sup> VMC GAS FURNACES

MODEL NUMBER	PART NUMBER	ITEM DESCRIPTION	INPUT MBH	OUTPUT MBH	DIMENSIONS H x W x D	WT. LBS.
VMC1-50D36N	08540005	FURNACE-GAS-50K-95% -3.5 T-VMC	50	48	76 1/8" x 18 3/4" x 25 3/4"	205
VMC1-75D36N	08540006	FURNACE-GAS-75K-95% -4.0 T-VMC	75	72	76 1/8" x 18 3/4" x 25 3/4"	205
VMC1-50DV3N	08540007	FURNACE-GAS-50K-95% -3.5 T-VMC-ES ★	50	48	76 1/8" x 18 3/4" x 25 3/4"	205
VMC1-75DV3N	08540008	FURNACE-GAS-75K-95% -4.0 T-VMC-ES ★	75	72	76 1/8" x 18 3/4" x 25 3/4"	205

## Revolv<sup>®</sup> Gas Furnace Accessories

08560001	COMBUSTIBLE BASE
08560002	CONCENTRIC VENT KIT with ROOF FLASHING
08560005	VMC-CONCENTRIC VENT KIT
08560006	VMC-ROOF FLASHING KIT
08560007	VMC-3"X4" DRAFT TRANSITION
08560008	VMC-3"X5" DRAFT TRANSITION
08560009	VMC-ROOF JACK CLOSEOFF
08560003	COIL CABINET 20"
08560004	COIL CABINET 24"



★ THE NEW VMC ENERGYSTAR ES- MODELS NOW AVAILABLE ★

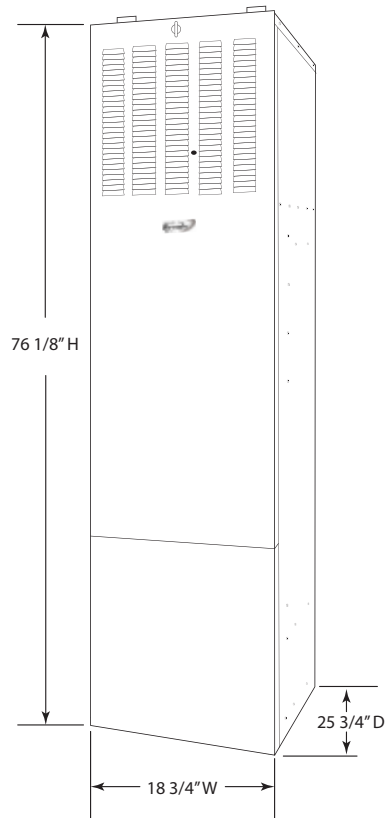



# VMA Series Gas Manufactured Housing Furnace

## Features:

**Ease of installation** – Fits standard MH furnace footprint.

**Easy conversion from natural gas to propane**–All models have convertible gas valves.

**A/C ready** – Up to 4.0 tons.\*

**4-speed blower** – Easily adapted to air flow needs of the home.

**Limited Lifetime** – Heat exchanger warranty.

**ETL Listed**

**Sealed Combustion design** – Provides draws combustion air from the outside.

**18-Gauge Aluminum** – Coated Primary Heat Exchanger & 24C Stainless Steel Secondary Heat Exchanger Provide Long Life on VMA.

**Standard footprint** – Easily replaces older MH furnaces.

**New high capacity** – Coil cabinet available.

**Energy Star** – Models available.

\*3.5 ton on 50K BTU 4.0 ton on 75K BTU



**Warranty**  
**5 Years Parts**

**Limited Lifetime Heat Exchanger**

Visit [www.stylecrestinc.com](http://www.stylecrestinc.com)  
for warranty registration

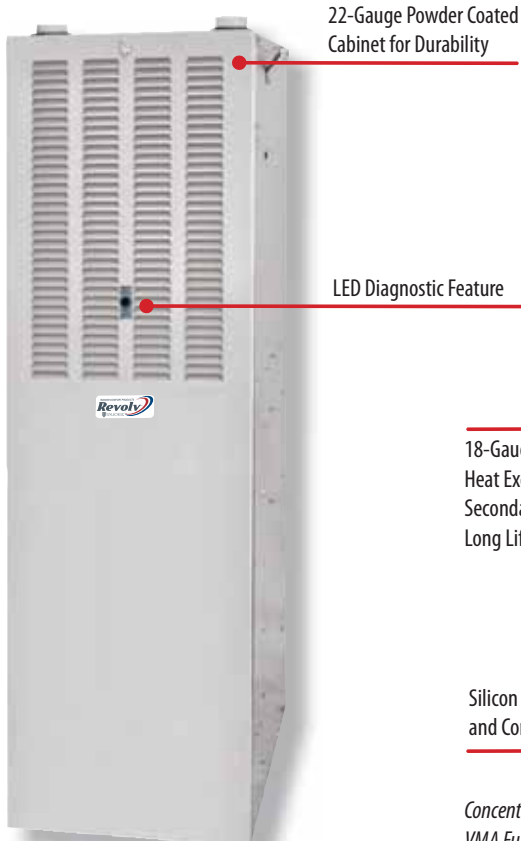

22-Gauge Powder Coated Cabinet for Durability

LED Diagnostic Feature

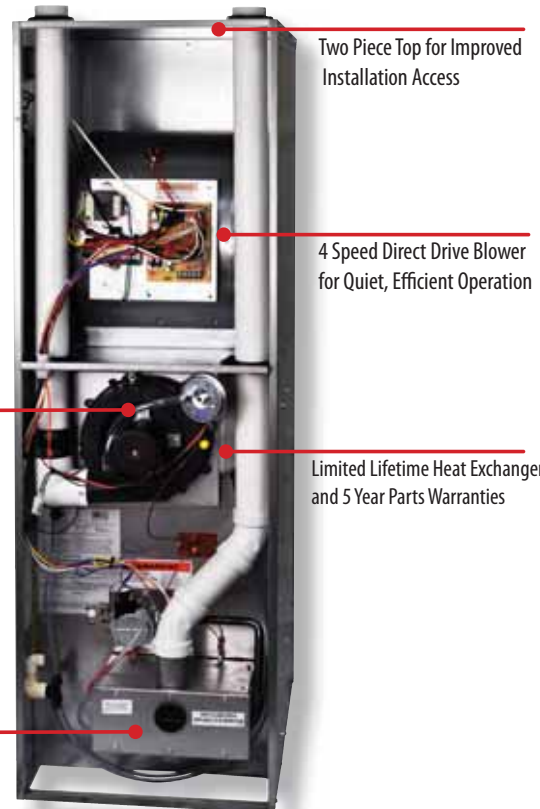

Two Piece Top for Improved Installation Access

4 Speed Direct Drive Blower for Quiet, Efficient Operation

18-Gauge Aluminum Coated Primary Heat Exchanger & 24C Stainless Steel Secondary Heat Exchanger Provide Long Life on VMA

Limited Lifetime Heat Exchanger and 5 Year Parts Warranties

Silicon Nitride Igniter for Quiet and Consistent Light-off

Concentric Vent Kit is available for VMA Furnace, Allowing Venting through the Existing Roof Jack

**Assembled in the U.S.A.**



## Revolv® VMA Series Gas Furnaces

### REVOLV® VMA GAS FURNACES

MODEL NUMBER	PART NUMBER	ITEM DESCRIPTION	INPUT MBH	OUTPUT MBH	DIMENSIONS H x W x D	WT. LBS.
VMA3-50D36N	08540003	FURNACE-GAS-50K-95% -3.5 T-VMA	50	48	57" x 18" x 25 3/4"	175
VMA3-75D36N	08540004	FURNACE-GAS-75K-95% -3.5 T-VMA	75	72	57" x 18" x 25 3/4"	175

### Revolv® Gas Furnace Accessories

08560001	COMBUSTIBLE BASE
08560002	CONCENTRIC VENT KIT with ROOF FLASHING
08560005	VMA-CONCENTRIC VENT KIT
08560006	VMA-ROOF FLASHING KIT
08560007	VMA-3"X4" DRAFT TRANSITION
08560008	VMA-3"X5" DRAFT TRANSITION
08560009	VMA-ROOF JACK CLOSEOFF
08560003	COIL CABINET 20"
08560004	COIL CABINET 24"

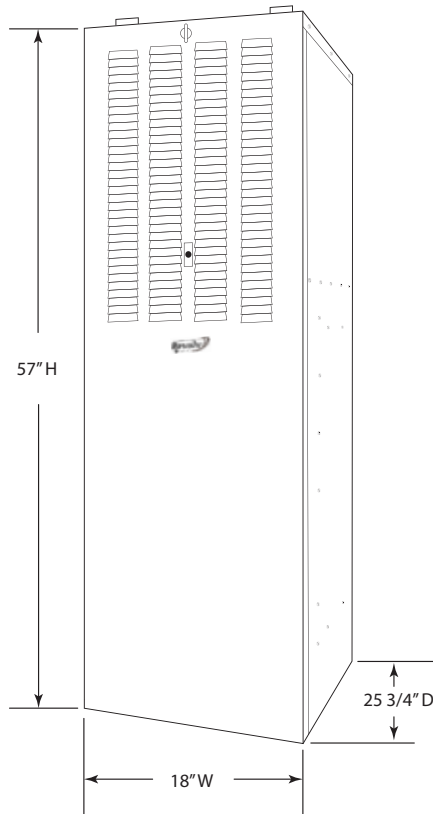

Product Availability, Prices and Specifications Subject to Change without Notice

# Revolv® VMA Series Gas Furnace Accessories

## ROOF FLASHING KIT



08560006 VMA ROOF FLASHING KIT

## ROOF JACK CLOSEOFF



08560009 VMA ROOF JACK CLOSEOFF

## COMBUSTIBLE BASE



08560001 COMBUSTIBLE BASE

## CONCENTRIC VENT KIT



08560005 VMA CONCENTRIC VENT KIT

## COIL CABINET



(Coil Sold Separately)

08560003 VMA COIL CABINET 20"  
08560004 VMA COIL CABINET 24"

## DRAFT TRANSITION



08560007 VMA DRAFT TRANSITION 3" x 4"  
08560008 VMA DRAFT TRANSITION 3" x 5"

# HEATING & AIR CONDITIONING

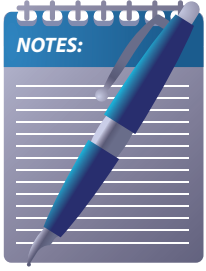

A series of horizontal blue lines for writing, starting from the top right of the page and extending down to the bottom right. The lines are evenly spaced and cover most of the page's width.

**A.C. DISCONNECT SWITCH**

THREE-PIECE CONSTRUCTION  
UP OPENING



598064 NONFUSIBLE 60 AMP

**CONNECTORS**



- 598042 1/2" STRAIGHT CONNECTOR  
25/CTN
- 598043 3/4" STRAIGHT CONNECTOR  
10/CTN
- 598045 1/2" 90° ELBOW CONNECTOR  
10/CTN
- 598046 3/4" 90° ELBOW CONNECTOR  
10/CTN

**LIQUID-TIGHT CONDUIT KIT**

FOR A.C. UNIT HOOKUP  
WIRE NONMETALLIC  
CONNECTORS  
ASSEMBLY, WIRE, CONDUIT & CONNECTORS



- 598077 3/4" x 6', #8 WIRE
- 598071 1/2" x 4', #10 WIRE
- 598073 1/2" x 6', #10 WIRE
- 598079 3/4" x 6', #6 WIRE

**TIME DELAY RELAY**

- REQUIRED WITH SOME APPLICATIONS
- 80 SECOND DELAY

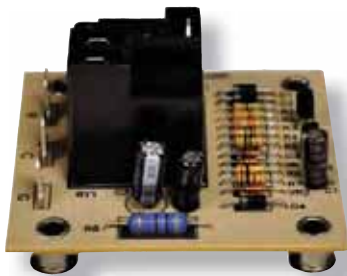

6918.5011 TDR SWITCH

**LIQUID-TIGHT CONDUIT**

FLEXIBLE, NONMETALLIC, TYPE B



- 598040 1/2" CONDUIT 100'
- 598041 3/4" CONDUIT 100'

**CONDENSATION DRAIN TRAP**

3/4"



5015411 3/4" CONDENSATION DRAIN TRAP

**A/C PADS**

DISTRIBUTES WEIGHT EVENLY, RESISTS BREAKAGE - LIGHT-WEIGHT, EASY TO INSTALL!



- 1124242D PAD A/C 24 X 24 X 2"
- 1130302D PAD A/C 30 X 30 X 2"
- 1134342D PAD A/C 34 X 34 X 2"

- 1124243D PAD A/C 24 X 24 X 3"
- 1130303D PAD A/C 30 X 30 X 3"
- 1132323D PAD A/C 32 X 32 X 3"
- 1136363D PAD A/C 36 X 36 X 3"
- 1136483D PAD A/C 36 X 48 X 3"
- 1145583D PAD A/C 45 X 58 X 3"
- 1145583D PAD A/C 45 X 58 X 3"
- 1152523D PAD A/C 52 X 52 X 3"

- H3232-4 PAD A/C 32 X 32 X 4"—150MPH
- H3636-4 PAD A/C 36 X 36 X 4"—150MPH
- H3652-4 PAD A/C 36 X 52 X 4"—150MPH
- 1145584 PAD A/C 45 X 58 X 4"—150MPH
- H3865-4 PAD A/C 38 X 65 X 4"—150MPH

- 1138524HT PAD-AC 38" X 52" X 4"—175MPH
- 1145584HT PAD-AC 45" X 58" X 4"—175MPH

- 1136368HP PAD-HP W/RISER 36" X 36" X 8"

OTHER SIZES AVAILABLE!

**SINGLE OUTDOOR THERMOSTAT**

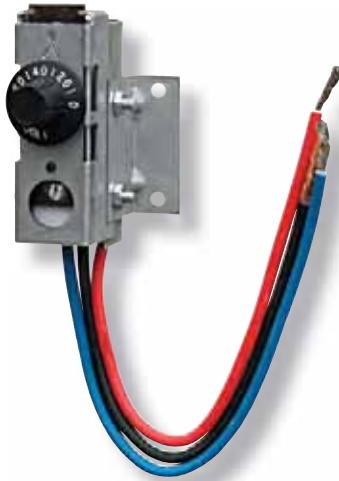

111020 THERMOSTAT  
OUTDOOR/SINGLE

**METAL FLOOR REGISTERS**

- SMOOTH OPERATION
- DUAL GATE, DIRECTIONAL AIR FLOW PADDLES
- WIDE FLANGES ON ALL FOUR SIDES
- MULTI-POINT WELDS



DOES NOT INCLUDE SCREWS

- 11CL48B 4" x 8" BROWN
- 11CL48W 4" x 8" WHITE
- 11CL410B 4" x 10" BROWN
- 11CL410W 4" x 10" WHITE
- 11CL412B 4" x 12" BROWN
- 11CL412W 4" x 12" WHITE

**PLASTIC FLOOR REGISTERS**

DISHWASHER SAFE - NO SHARP EDGES  
LIGHTWEIGHT, NEARLY INDESTRUCTIBLE



- 1178481 4" x 8" WHITE—40/CTN
- 1178487 4" x 8" BROWN—40/CTN
- 1178401 4" x 10" WHITE—40/CTN
- 1178407 4" x 10" BROWN—40/CTN

**BACKFLOW DAMPER FOR RE, RG, & M5 SERIES**



901083



902095

- 901083 PKG. AC BACKFLOW DAMPER GAS/OIL FURNACE
- 902095 PKG. AC BACKFLOW DAMPER GAS/OIL FURNACE



**DRAFT CAP**

FOR SINGLE WALL PIPE APPLICATION



- 522086 4" FLUE SIZE-8/CTN
- 522095 5" FLUE SIZE-8/CTN

**REGISTER COLLARS**

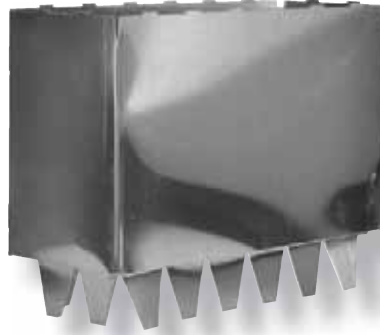

- 11486 4" W x 8" D x 6" LONG 48/CTN
- 114106 4" W x 10" D x 6" LONG 48/CTN

**UNIVERSAL THERMOCOUPLE KITS**



- 11923 THERMOCOUPLE AND ADAPTOR 30" KIT

**FURNACE FILTER**



- 11050001 FILTER 2 PAK 17" x 24" TRIMMABLE

**FURNACE FILTER**



- 11110611 TECH FAB BLUE FILTER 16" x 20" WASHABLE



**MANUFACTURED HOUSING**

**FURNACE FILTERS**



1122515 16" x 20" FIBERGLASS FILTER  
 1122517 20" x 20" FIBERGLASS FILTER

**FURNACE FILTERS**



1162036 ¼" x 19" x 36" FOAM FILTER  
 1161026 ¼" x 16" x 26" FOAM FILTER  
 FOR MILLER/INTERTHERM  
 1163054 ¼" x 19" x 54" FOAM FILTER  
 FOR MILLER/INTERTHERM

**FURNACE FILTER**



119401 METAL FILTER 15 ½" x 20" EACH  
 1196935689 FILTER / METAL  
 15.9" x 19" (PAIR)

**FURNACE FILTER KITS**

TWO FILTERS WITH MOUNTING BRACKETS

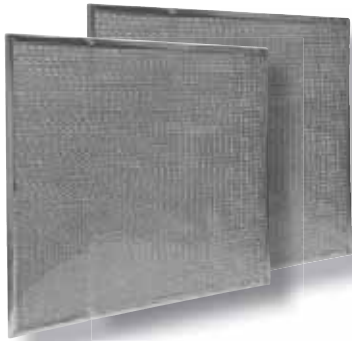

921784A FILTER KIT 15" x 17" MC 18"  
 921785A FILTER KIT 17" x 21" MC 24"  
 1006697 FILTER KIT 17" x 28" MC 29"

**FURNACE FILTER**

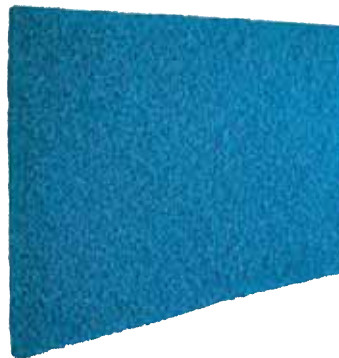

07540020 FILTER-VMA/C 1" x 18" x 24"

**METAL FLASHING**



60850 8" x 50' ALUMINUM  
 601050 10" x 50' ALUMINUM  
 6010501 10" x 50' GALVANIZED

## THERMOSTAT

- RUGGED SNAP-ACTION CONTACTS
- ADJUSTABLE HEAT ANTICIPATOR
- BI-METAL THERMOMETER
- CLASSIC WHITE COLOR



111001 COOL ONLY THERMOSTAT

111002 HEAT ONLY THERMOSTAT

## THERMOSTAT

- RUGGED SNAP-ACTION CONTACTS
- ADJUSTABLE HEAT ANTICIPATOR
- BI-METAL THERMOMETER
- HEAT/COOL MODEL INCLUDES SWITCHING SUBBASE
- HEAT/COOL MODEL COMPATIBLE WITH ELECTRIC HEAT SYSTEMS
- CLASSIC WHITE COLOR



111003 HEAT/COOL THERMOSTAT

## THERMOSTAT

- HEATING AND COOLING 4 WIRE (24)



02538747000 THERMOSTAT HEAT/COOL 4 WIRE

## HEATING & AIR CONDITIONING

### THERMOSTAT

NON-PROGRAMMABLE

- FOSSIL FUEL OR ELECTRIC HEAT COMPATIBLE
- LARGE LCD WITH BACKLIGHT
- SELECTABLE CELSIUS OR FAHRENHEIT TEMPERATURE DISPLAY
- INCLUDES B/O TERMINALS
- ELECTRONIC ACCURACY



FURNACES AND A/C

111007 DIGITAL NON PROGRAMMABLE T-STAT 1H/1C

### THERMOSTAT

PROGRAMMABLE

- FOSSIL FUEL OR ELECTRIC HEAT COMPATIBLE
- LARGE LCD WITH BACKLIGHT
- SELECTABLE CELSIUS OR FAHRENHEIT TEMPERATURE DISPLAY
- INCLUDES B/O TERMINALS
- ELECTRONIC ACCURACY



FURNACES AND A/C

111006 DIGITAL PROGRAMMABLE T-STAT 1H/1C

### THERMOSTAT

NON-PROGRAMMABLE

- ELECTRIC HEAT COMPATIBLE
- LARGE LCD WITH BACKLIGHT
- SELECTABLE CELSIUS OR FAHRENHEIT TEMPERATURE DISPLAY
- INCLUDES B/O TERMINALS
- ELECTRONIC ACCURACY



FURNACES AND HEAT PUMP

111005 DIGITAL NON PROGRAMMABLE T-STAT 2H/1

## HEATING & AIR CONDITIONING

### THERMOSTAT

PROGRAMMABLE

- ELECTRIC HEAT COMPATIBLE
- LARGE LCD WITH BACKLIGHT
- SELECTABLE CELSIUS OR FAHRENHEIT TEMPERATURE DISPLAY
- INCLUDES B/O TERMINALS
- ELECTRONIC ACCURACY



FURNACES AND HEAT PUMP

111004 DIGITAL PROGRAMMABLE T-STAT 2H/1C

### THERMOSTAT DIGITAL MULTI FUNCTION

- LARGE EASY-TO-READ BACKLIT TOUCH SCREEN DISPLAY WITH EASY TO USE SETUP
- USER SELECTABLE PROGRAMMING (7 DAY, 5/11 DAY WITH 4 TIME AND TEMP SETTINGS PER PROGRAM
- MAINTAINS ROOM TEMPERATURE +/- 1° F
- APPLICABLE FOR SINGLE AND MULTIPLE STAGE HEAT (A/C AND H/P OPERATION)
- WIRING OPTIONS-BATTERY OPERATION OR HARD-WIRED WITH BATTERY BACKUP
- BUILT IN DIAGNOSTIC INDICATOR
- FILTER CHANGE REMINDER
- AUTO CHANGEOVER OPTION-AUTOMATICALLY CHANGES FROM HEATING MODE TO COOLING
- TEMPORARY TEMPERATURE OVERRIDE-15 MINUTE OR 7-DAY VACATION MODES
- DUAL FUEL CAPACITY



111010 DIGITAL PROGRAMMABLE T-STAT MULTIFUNCTION



**MANUFACTURED HOUSING**



# Interior Lighting *Series*

## 6" CEILING FIXTURE

BRUSHED NICKEL  
SINGLE LIGHT  
(GLOBE SOLD SEPARATELY)



59202401 6" 1LT CEILING FIXTURE BRUSHED NICKEL 48/CARTON

## 6" CEILING FIXTURE

GLOSS WHITE  
SINGLE LIGHT  
(GLOBE SOLD SEPARATELY)



59202008 6" 1LT CEILING FIXTURE GLOSS WHITE

## 6" GLOBE

ALABASTER



591302 6" GLOBE ALABASTER

## 6" GLOBE

WHITE



591013 6" GLOBE WHITE

## 6" GLOBE

CLEAR GLASS BARREL



591194 6" GLOBE CLEAR BARREL  
(FITS 591190) 48/CARTON

# Interior Lighting *Series*

## **7" CEILING FIXTURE**

BRUSHED NICKEL  
SINGLE LIGHT  
(GLOBE SOLD SEPARATELY)



59220401 7" 1LT CEILING FIXTURE BRUSHED NICKEL

## **7" CEILING FIXTURE**

GLOSS WHITE  
SINGLE LIGHT  
(GLOBE SOLD SEPARATELY)



59220008 7" 1LT CEILING FIXTURE GLOSS WHITE

## **7" GLOBE**

ALABASTER



591567 7" GLOBE ALABASTER



**MANUFACTURED HOUSING**



# Interior Lighting *Series*

## **9" CEILING FIXTURE**

BRUSHED NICKEL  
TWO LIGHT  
(GLOBE SOLD SEPARATELY)



59215401 9" 2 LT CEILING FIXTURE BRUSHED NICKEL

## **9" CEILING FIXTURE**

GLOSS WHITE  
TWO LIGHT  
(GLOBE SOLD SEPARATELY)



59215008 9" 2 LT CEILING FIXTURE GLOSS WHITE

## **9" GLOBE**

ETCHED DIAMOND GLASS



591575 9" GLOBE ETCHED DIAMOND GLASS



**MANUFACTURED HOUSING**

# Interior Lighting *Series*

## **11" CEILING FIXTURE**

BRUSHED NICKEL  
TWO LIGHT  
(GLOBE SOLD SEPARATELY)



59023401 11" 2LT CEILING FIXTURE BRUSHED NICKEL

## **13" CEILING FIXTURE**

BRUSHED NICKEL  
TWO LIGHT  
(GLOBE SOLD SEPARATELY)



59024401 13" 2 LT CEILING FIXTURE BRUSHED NICKEL

## **11" GLOBE**

ALABASTER



59225040 11" GLOBE ALABASTER



**MANUFACTURED HOUSING**

# Interior Lighting *Series*

**12" GLOBE**  
SQUARE GLASS



59010002 12" GLOBE SQUARE GLASS 24/CARTON

**14" GLOBE**  
WHITE PLASTIC  
DIFFUSER



5911501 14" GLOBE PLASTIC DIFFUSER

**CEILING FIXTURE**  
GLOSS WHITE  
TWO LIGHT  
(GLOBE SOLD SEPARATELY)



591203 2 LT CEILING FIXTURE  
GLOSS WHITE 48/CARTON

**PLASTIC FINIAL**  
WHITE  
(LIGHTING ACCESSORIES)



59010001 PLASTIC FINIAL EACH

**GLOBE**  
ALABASTER BELL



591234 GLOBE ALABASTER BELL

# Interior Lighting *Series*

## **18" VANITY PENDANT FIXTURE**

BRUSHED NICKEL  
(GLOBES SOLD SEPARATELY)



59832401 18" 2LT VANITY PENDANT BRUSHED NICKEL

## **18" VANITY BAR FIXTURE**

BRUSHED NICKEL  
(BULBS SOLD SEPARATELY)



59323401 18" VANITY BAR BRUSHED NICKEL 6/CARTON



**MANUFACTURED HOUSING**

# Outdoor Lighting *Series*

## COACH PORCH FIXTURE

BRUSHED NICKEL  
1 LIGHT



59406502 COACH PORCH BRUSHED NICKEL

## LANTERN PORCH FIXTURE

BRUSHED NICKEL  
1 LIGHT



59523502 LANTERN PORCH BRUSHED NICKEL

## EXTERIOR FIXTURE

BLACK PLASTIC  
(GLOBE SOLD SEPARATELY)



591190 BLACK PLASTIC EXTERIOR FITS 591194 48/CARTON

## GLOBE

CLEAR GLASS BARREL



591194 CLEAR GLASS BARREL 48/CARTON

# Outdoor Lighting *Series*

## PORCH LIGHT WITH GLOBE

BLACK



## PORCH LIGHT WITH GLOBE

WHITE



591671194 PORCH LIGHT W/GLOBE BLACK 4/CARTON

596788 PORCH LIGHT W/GLOBE WHITE 4/CARTON

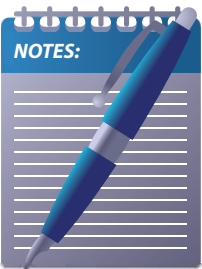

A series of horizontal blue lines for taking notes, starting from the top of the notepad icon and extending across the width of the page.

## ELECTRICAL

### SMOKE ALARM

120 VOLT WITH BATTERY BACK-UP  
U.L. APPROVED



59604016 OFF WHITE, 5 1/4" DIAMETER  
120 VOLT WITH BATTERY  
BACKUP U.L. APPROVED  
6/CTN

### SMOKE ALARM

BATTERY U.L. APPROVED



594112 OFF WHITE, 5 1/4" DIAMETER  
2"H, 9 VOLT BATTERY  
INCLUDED—12/CTN



**MANUFACTURED HOUSING**

### BATHROOM CEILING FAN



WITH LIGHT

59200 VERTICAL OUTLET, 10 3/4" R.O.  
USES 7 1/8" DIAMETER DUCT  
59VC0133-00 COVER LENS FOR 59200  
59312 FAN BLADE FOR 59200

WITHOUT LIGHT

592262 BATHROOM FAN ASSEMBLY  
590388 REPLACEMENT MOTOR  
590574 REPLACEMENT COVER

### RANGE CORD

FOUR PRONG BLADE  
FOUR WIRE



59ER2050 4' RANGE CORD; 50 AMP  
12/CARTON

### DRYER CORD

FOUR PRONG - FOUR WIRE



05020002 4' DRYER CORD; 30 AMP

**ELECTRICAL**

**GROUND FAULT CIRCUIT INTERRUPTER**

15 AMP, 125V



59131851 WHITE, 15 AMP / 125V  
59131842 IVORY, 15 AMP / 125V

**RANGE RECEPTACLE**

50 AMP 4-WIRE, SURFACE MOUNTING



5955050 U.L. LISTED, 125 / 250V  
CSA APPROVED 10/CARTON

**DRYER RECEPTACLE**

4- WIRE, 30 AMP, SURFACE MOUNT



591225 125 / 250V 10/CARTON

**ROOF CAP 5"**

CAP & FLANGE



522005 4 3/4" ABOVE ROOF LINE  
5" DIA. ATTIC VENT 26/CARTON

**ROOF CAP 7"**

CAP & FLANGE FOR FLAT ROOF



591505 ROOF CAP FOR FLAT ROOF ONLY  
8/CARTON

**ROOF CAP 7"**

CAP & FLANGE FOR SLOPED ROOF OF 12°



59201 COMPLETE ASSEMBLY FOR  
SLOPED ROOF 12° ANGLE  
FOR VERTICAL OUTLET FANS  
4/CARTON



**ROCKER SWITCH-EASY 3 PIECE SNAP ON**



**NOTE: 59153101 rocker switch can be ganged with 59153321 double coverplate for multi-switch applications**



- 59153101 SWITCH-SC DECO W/O COVEPLATE
- 59153311 COVERPLATE-RECEPTACLE-SNAP ON WHITE
- 59153321 COVERPLATE-DOUBLE DECO-SNAP ON WHITE

**DUPLEX RECEPTACLE-EASY 2 PIECE SNAP ON**

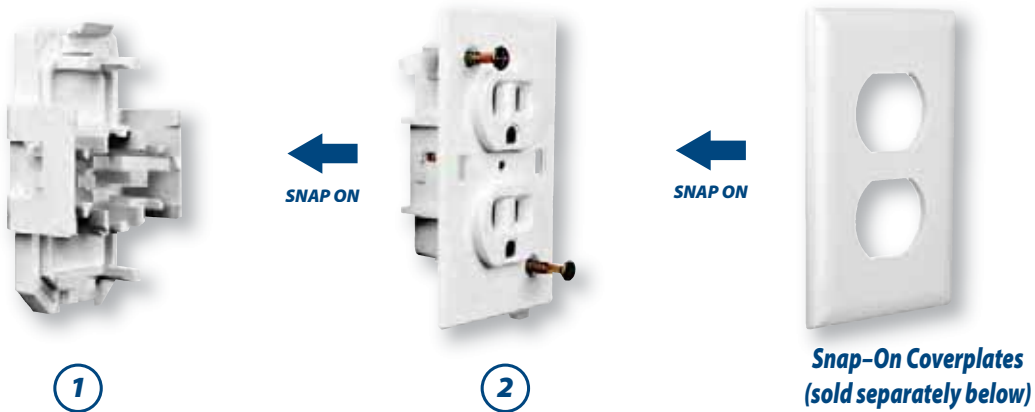

- 59153201 RECPTACLE-DUPLEX SC W/O COVERPLATE
- 59153211 COVERPLATE-DOUBLE DECO-SNAP ON WHITE

# ELECTRICAL

## DUPLEX RECEPTACLE

AUTOMATIC GROUNDING



- 5953201 WHITE, 15AMP / 125V  
10/CARTON
- 5953202 IVORY, 15AMP / 125V  
10/CARTON

## SINGLE POLE TOGGLE SWITCH

AUTOMATIC GROUNDING



- 5914511 WHITE - 15AMP; 1/2HP 120V  
10/CARTON
- 5914512 IVORY - 15AMP; 1/2HP 120V  
10/CARTON

## ROCKER SWITCH

SINGLE PADDLE



- 596043 WHITE, 15AMP / 125V  
10/CARTON
- 596044 IVORY, 15AMP / 125V  
10/CARTON

## DUPLEX RECEPTACLE COVERPLATE



- 5939031 WHITE - SMOOTH SURFACE
- 5939032 IVORY - SMOOTH SURFACE

## SINGLE POLE TOGGLE SWITCH COVERPLATE

SINGLE TOGGLE



- 5939011 WHITE - SMOOTH SURFACE
- 5939012 IVORY - SMOOTH SURFACE

## ROCKER SWITCH COVERPLATE

SINGLE PADDLE



- 59611507 WHITE
- 59611500 IVORY

## 30" GAS RANGE—WHITE WITH CLOCK AND TIMER

FRIGIDAIRE®

**FEATURES:**

- LARGE 4.2 CU. FT. OVEN GIVES MORE ROOM TO COOK MULTIPLE ITEMS AT ONCE
- COOKTOP HAS FOUR 9,000 BTU GAS BURNERS AND STURDY BLACK STEEL SQUARE GRATES
- EASY-TO-CLEAN PORCELAIN ON STEEL OVEN
- EVEN BAKING™ TECHNOLOGY ENSURES THAT FOOD COMES OUT EVENLY
- BROIL AND SERVE™ LOWER DRAWER FEATURES A 18,000 BTU VARIABLE TEMP BROILER
- EASY-SET FRONT MOUNTED CONTROLS WITH BUSH-TO-TURN CONTROL KNOBS
- STYLISH COLOR-COORDINATED OVEN DOOR HAS A LARGE WINDOW THAT MAKES IT EASY TO CHECK ON WHAT IS COOKING
- TWO OVEN RACKS CAN BE CONFIGURED TO ACCOMODATE A VARIETY OF BAKING NEEDS
- LIMITED 1-YEAR WARRANTY

**COOKTOP**

- RIGHT FRONT BURNER: 9,000 BTU
- RIGHT REAR BURNER: 9,000 BTU
- LEFT FRONT BURNER: 9,000 BTU
- LEFT REAR BURNER: 9,000 BTU

**APPROXIMATE DIMENSIONS:**

- HEIGHT: 45 ¾"
- WIDTH: 27 ⅞"
- DEPTH: 25 ¾"

**GENERAL SPECIFICATIONS**

- SHIPPING WEIGHT (APPROX.): 150 LBS



05310011 30" RANGE GAS W/CLOCK & TIMER— WHITE

## 30" GAS RANGE—BLACK WITH CLOCK AND TIMER

FRIGIDAIRE®

**FEATURES:**

- LARGE 4.2 CU. FT. OVEN GIVES MORE ROOM TO COOK MULTIPLE ITEMS AT ONCE
- COOKTOP HAS FOUR 9,000 BTU GAS BURNERS AND STURDY BLACK STEEL SQUARE GRATES
- EASY-TO-CLEAN PORCELAIN ON STEEL OVEN
- EVEN BAKING™ TECHNOLOGY ENSURES THAT FOOD COMES OUT EVENLY
- BROIL AND SERVE™ LOWER DRAWER FEATURES A 18,000 BTU VARIABLE TEMP BROILER
- EASY-SET FRONT MOUNTED CONTROLS WITH BUSH-TO-TURN CONTROL KNOBS
- STYLISH COLOR-COORDINATED OVEN DOOR HAS A LARGE WINDOW THAT MAKES IT EASY TO CHECK ON WHAT IS COOKING
- TWO OVEN RACKS CAN BE CONFIGURED TO ACCOMODATE A VARIETY OF BAKING NEEDS
- LIMITED 1-YEAR WARRANTY

**COOKTOP**

- RIGHT FRONT BURNER: 9,000 BTU
- RIGHT REAR BURNER: 9,000 BTU
- LEFT FRONT BURNER: 9,000 BTU
- LEFT REAR BURNER: 9,000 BTU

**APPROXIMATE DIMENSIONS:**

- HEIGHT: 45 ¾"
- WIDTH: 27 ⅞"
- DEPTH: 25 ¾"

**GENERAL SPECIFICATIONS**

- SHIPPING WEIGHT (APPROX.): 150 LBS



05310003B 30" RANGE GAS W/CLOCK & TIMER — BLACK

## 30" ELECTRIC RANGE—WHITE WITH CLOCK AND TIMER

FRIGIDAIRE®

**FEATURES:**

- STORE-MORE™ STORAGE DRAWER
- COLOR-COORDINATED OVEN DOOR WITH LARGE WINDOW
- BRIGHT LIGHTING
- MANUAL CLEAN OVEN
- LIFT-UP PORCELAIN COOKTOP
- CHROME DRIP BOWLS
- TOWEL-BAR HANDLE
- 2 OVEN RACKS

**COOKTOP SPECIFICATIONS**

- COOKING SURFACE: SLABTOP COIL W/ CHROME BOWLS
- RIGHT FRONT: 6" - 1,250 WATTS
- RIGHT REAR: 6" - 1,250 WATTS
- LEFT FRONT: 8" - 2,100 WATTS
- LEFT REAR: 6" - 1,250 WATTS

**APPROXIMATE DIMENSIONS:**

- HEIGHT: 47"
- WIDTH: 29 7/8"
- DEPTH: 28 1/2"

**GENERAL SPECIFICATIONS**

- SHIPPING WEIGHT (LBS): 140



05310010 30" RANGE ELEC W/CLOCK & TIMER—WHITE  
59ER2050 RANGE CORD 50AMP, 4', 4-WIRE SOLD SEPERATELY

## 30" ELECTRIC RANGE—BLACK WITH CLOCK AND TIMER

FRIGIDAIRE®

**FEATURES:**

- STORE-MORE™ STORAGE DRAWER
- COLOR-COORDINATED OVEN DOOR WITH LARGE WINDOW
- BRIGHT LIGHTING
- MANUAL CLEAN OVEN
- LIFT-UP PORCELAIN COOKTOP
- CHROME DRIP BOWLS
- TOWEL-BAR HANDLE
- 2 OVEN RACKS

**COOKTOP SPECIFICATIONS**

- COOKING SURFACE: SLABTOP COIL W/ CHROME BOWLS
- RIGHT FRONT: 6" - 1,250 WATTS
- RIGHT REAR: 6" - 1,250 WATTS
- LEFT FRONT: 8" - 2,100 WATTS
- LEFT REAR: 6" - 1,250 WATTS

**APPROXIMATE DIMENSIONS:**

- HEIGHT: 47"
- WIDTH: 29 7/8"
- DEPTH: 28 1/2"

**GENERAL SPECIFICATIONS**

- SHIPPING WEIGHT (LBS): 140



05310013 30" RANGE ELEC W/CLOCK & TIMER—BLACK  
59ER2050 RANGE CORD 50AMP, 4', 4-WIRE SOLD SEPERATELY

## 16.3 CUBIC FOOT REFRIGERATOR TOP FREEZER—WHITE

FRIGIDAIRE®

### STORE-MORE™ HUMIDITY-CONTROLLED CRISPER DRAWERS

- KEEP YOUR FRUITS AND VEGETABLES FRESH IN OUR HUMIDITY CONTROLLED CRISPER DRAWERS.

### BUILT WITH AMERICAN PRIDE

- APPLIANCES THAT ARE HIGH-PERFORMING, MORE ACCESSIBLE, AND MORE INNOVATIVE THAN EVER—DESIGNED, BUILT, AND ENGINEERED IN THE U.S.A.

### STORE-MORE™ GALLON DOOR SHELF

- DOOR STORAGE GIVES YOU ROOM FOR LARGER ITEMS LIKE A GALLON OF MILK.

### SQUARE DOOR DESIGN FULL-WIDTH FREEZER RACK

- ENJOY MORE USABLE SPACE AND BETTER ORGANIZATION.

### REVERSIBLE DOOR

- DOOR CAN BE INSTALLED TO OPEN LEFT OR RIGHT BASED ON YOUR NEEDS.

### APPROXIMATE DIMENSIONS:

- EXTERIOR WIDTH: 28"
- CABINET WIDTH: 28"
- EXTERIOR DEPTH: 30 1/8"

### GENERAL SPECIFICATIONS

- SHIPPING WEIGHT (APPROX.): 190 LBS



05310008 16.3 CUBIC FOOT REFRIGERATOR TOP FREEZER—WHITE  
05020001 ICE MAKER KIT FOR FRIGIDAIRE FREEZER

## 24" BUILT-IN DISHWASHER—WHITE

FRIGIDAIRE®

### TALL-TUB DESIGN

- OUR LARGE CAPACITY, TALL-TUB DISHWASHER FITS UP TO 14 PLACE SETTINGS SO YOU CAN WASH MORE AT ONCE

### WASH LEVELS

- 5 WASH LEVELS
- 3 WASH ARMS

### WASH CYCLES

- 3 THREE WASH ARMS

### DELAY START

- SET YOUR DISHWASHER TO RUN ON YOUR SCHEDULE

### SPACEWISE® SILVERWARE BASKET

- THERE'S A PLACE FOR ALL OF YOUR SILVERWARE IN OUR MULTI-COMPARTMENT, REMOVABLE BASKET

### READY-SELECT® CONTROLS

- EASILY SELECT OPTIONS WITH THE TOUCH OF A BUTTON

### EXTERIOR DIMENSIONS

- HEIGHT 33 1/2" TO 35" ADJUSTABLE
- WIDTH 24"
- DEPTH 25"



05310005 24" BUILT-IN DISHWASHER—WHITE  
5941046 DISHWASHER WATER LINE KIT—SOLD SEPERATELY

## 6.5 CUBIC FOOT DRYER—WHITE ELECTRIC OR GAS



### FEATURES

- MODERN STYLING
- WRINKLE PREVENT OPTION
- AUTOMATIC DRYNESS CONTROL
- 3 DRYING TEMPERATURES
- 60 MINUTE TIMED DRY
- AIR FLUFF CYCLE
- ON/OFF END-OF-CYCLE SIGNAL
- OPTIONAL DRYING RACK
- 7 CYCLES
- WIDE-OPENING REVERSIBLE-SWING DOOR

### EXTERIOR DIMENSIONS

- HEIGHT 42 ½"
- WIDTH 29"
- DEPTH 28 ½"

### GENERAL SPECIFICATIONS

- PRODUCT WEIGHT (LBS): 121



05A881 6.5 CUBIC FOOT ELECTRIC DRYER—WHITE

05A882 6.5 CUBIC FOOT GAS DRYER—WHITE

05020002 POWER CORD —SOLD SEPERATELY

## 3.6 CUBIC FOOT WASHER—WHITE



### FEATURES

- SPRECKLE PORCELAIN WASH BASKET
- 700 RPM MAX SPIN SPEED
- DELUXE DUAL ACTION AGITATOR
- CYCLE STATUS BAR
- ADVANCED SUSPENSION SYSTEM
- 9 WASH CYCLES
- AUTOMATIC TEMPERATURE CONTROL
- CASUAL CYCLE
- LOAD-SIZE OPTION
- DELICATE CYCLE

### EXTERIOR DIMENSIONS

- HEIGHT 43"
- WIDTH 27 ½"
- DEPTH 26"



05A772 3.6 CUBIC FOOT WASHER—WHITE

050166 INLET HOSES 2PK-4' LONG —SOLD SEPERATELY

# 1.5 CU. FT. OVER-THE-RANGE MICROWAVE—WHITE

# FRIGIDAIRE

**ONE-TOUCH OPTIONS**

- OUR MICROWAVES FEATURE EASY-TO-USE ONE-TOUCH BUTTONS SO YOU CAN COOK BAKED POTATOES, POPCORN OR EVEN 30 SECONDS WITH THE TOUCH OF A BUTTON

**READY-SELECT® CONTROLS**

- EASILY SELECT OPTIONS WITH THE TOUCH OF A BUTTON

**10 COOKING POWER LEVELS**

**AUTO-REHEAT OPTIONS**

**ELECTRONIC CLOCK/TIMER**

**AUTO-START HEAT SENSOR VENT FAN**

**CAPACITIES**

- CAPACITY (CU. FT.) 1.5

**EXTERIOR DIMENSIONS**

- HEIGHT 16 13/32"
- WIDTH 29 7/8"
- DEPTH 15 1/32"



05310006 1.5 CU. FT. OVER-THE-RANGE MICROWAVE—WHITE

## EXHAUST FAN SIDEWALL

FOR 2 3/4" - 4" THICK WALLS



5920154 9 1/2" x 9 1/2" R.O.  
115V. MEDIUM MOTOR  
MILL FINISH W/ GRILL 6/CTN

## EXHAUST FAN GRILL



59564 REPLACEMENT GRILL  
(USE WITH 5920154) 15/CTN

## POWER RANGE HOOD

POWER - WITH LIGHT  
TOP OR BACK SQUARE EXHAUST



FRONT



BACK

59112301 WHITE, 115V, 12" x 30"

## APPLIANCES

### VENTED RANGE HOOD

POWER - WITH LIGHT  
ROUND TOP EXHAUST

**VENTLINE**  
By DEXTER



FRONT



BACK

59012301 WHITE, 12" x 30"

### RANGEHOOD OUTLET ADAPTER

8" X 8" (FOR SINGLE AND TWO SPEED)

**VENTLINE**  
By DEXTER



591579 RANGE HOOD OUTLET ADAPTER

### POWER RANGE HOOD

POWER - WITH LIGHT  
TOP OR BACK SQUARE EXHAUST

**VENTLINE**  
By DEXTER



FRONT



BACK

5912421 WHITE, 12" x 42", POWER

### RANGEHOOD FAN MOTOR

115 VOLT

**VENTLINE**  
By DEXTER



59361 RANGE HOOD FAN MOTOR 115V

### RANGEHOOD GREASE FILTER

8" X 8" (FOR SINGLE AND TWO SPEED)

**VENTLINE**  
By DEXTER



591070 FILTER GREASE 8" x 8" (FOR SINGLE AND TWO SPEED) FOR RANGEHOOD

### SWITCH—FAN ROCKER

BLACK

**VENTLINE**  
By DEXTER



591193 SWITCH - FAN, ROCKER BLACK 1 SPEED



## APPLIANCES

### SWITCH-FAN ROCKER

BLACK—2 SPEE

**VENTLINE**  
By DEXTER



591198 SWITCH - FAN, ROCKER BLACK  
2 SPEED

### FANBLADE—RANGEHOOD

FOR ROUND OUTLET SINGLE SPEED

**VENTLINE**  
By DEXTER



590311 FANBLADE - RANGEHOOD  
RND OUTLET SINGLE SPEED

### FANBLADE—RANGEHOOD

FOR SQUARE OUTLET

**VENTLINE**  
By DEXTER



590409 FANBLADE - RANGEHOOD  
SQUARE OUTLET

### OUTSIDE VENT COVER

WEATHERPROOF WITH LOCKABLE  
DAMPER. 1 3/4" INLET, WHITE.  
3 1/2" x 10.5" RO. COLONIAL WHITE

**VENTLINE**  
By DEXTER



591111 OUTSIDE VENT COVER

### 6" ELECTRIC RANGE BURNER

PLUG-IN



59142 6" ELECTRIC RANGE BURNER  
PLUG-IN

### 8" ELECTRIC RANGE BURNER

PLUG-IN



59152 8" ELECTRIC RANGE BURNER  
PLUG-IN

APPLIANCES

**6" COMBINATION DRIP PAN & RING**



59382 6" COMBINATION DRIP PAN & RING

**8" COMBINATION DRIP PAN & RING**



59392 8" COMBINATION DRIP PAN & RING

**6" TRIM RING ONLY**



591052 6" TRIM RING ONLY 6/CTN

**8" TRIM RING ONLY**



591054 8" TRIM RING ONLY 12/CTN

**6" DRIP PAN ONLY**



591056 6" DRIP PAN ONLY 12/CTN

**8" DRIP PAN ONLY**



591058 8" DRIP PAN ONLY 12/CTN

## APPLIANCES

### UNIVERSAL RECEPTACLE BLOCK



5900873 UNIVERSAL RECEPTACLE  
BLOCK 12/CTN

### RANGE CORD FOUR PRONG BLADE FOUR WIRE



59ER2050 4' RANGE CORD  
50 AMP, 4 - WIRE

### 4 WIRE DRYER CORD 4' IN LENGTH, 30 AMP



05020002 DRYER CORD, 4'  
30 AMP, 4 - WIRE

### DISHWASHER HOOKUP KIT



5941046 DISHWASHER HOOK UP KIT

### WASHER INLET HOSES 4' LONG 2 PK



050166 WASHER INLET HOSES 4'  
2 PK

### ICEMAKER KIT



050130 INSTALLATION KIT  
W/POLY TUBE - 25'

## APPLIANCES

### LIGHTBULB



600540 LIGHTBULB 40W  
FOR APPLIANCES

### HOSE CLAMP



050164 CLAMP HOSE 3 5/8" TO 4 1/2"

### FOOD WASTE DISPOSER

- CONTINUOUS FEED
- QUICK-LOCK MOUNTING
- DISHWASHER DRAIN CONNECT



05010001 1/3 HP FOOD WASTE  
DISPOSER

### DRYER VENT KIT WITH RIGID SUPUR-FLEX®

IN 4 - COLOR CARTON

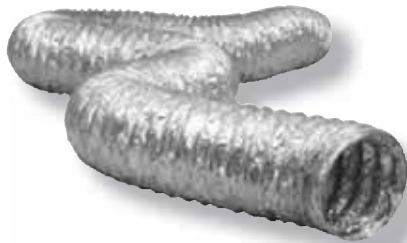

050152 FLEXIBLE METALIC DUCT  
4" x 25'

### DRYER VENT KIT WITH SEMI-RIGID SUPUR-FLEX®

DESIGNED & ENGINEERED FOR DRYER VENT-  
ING HOLDS RIGID SHAPE WHEN STRETCHED



050151 DRYER UNIT KIT  
WHITE HOOD, 5' FLEX DUCTING,  
CLAMPS, COLLAR AND PIPE  
050153 DRYER VENT KIT  
FLEXIBLE ALUM. DUCT - RIGID, 8'



MANUFACTURED HOUSING

# Kinro<sup>®</sup> Mobile Home Door Measurement Guide



There are several factors to help determine that the correct Kinro door is selected:

## • Type-Does the customer need an:

- Outswing door**—this is a single door hinged on the outside that opens outward. It does not have a storm door. This is a series 5140 door
- Combination or House type door**—this door has a main door that opens inward, and a storm door attached on the outside. This is economical upgrade form the outswing door with a variety of options. This is a series 5210 door
- Upgrade combination door**—this door also has a main door that opens inward and a storm door, but the main door is a stronger, higher quality door (6 panel or flat steel-and a larger variety of window options). This is a series 7660 door
- Storm door only**—if only the storm door needs replaced, it may be ordered separately. Please note that care needs to be taken when removing the old storm door, since this is the attachment method of the door assembly to the house. The storm door also keeps the door assembly square in the opening. Anyone replacing a storm door must take care to secure the main door in place and maintain it square fitting in the door jamb. Note also that storm doors are not universal in size or application. Different brands of doors use different sizes of storm doors and do not interchange. This is a series 5600 door.

## • Hand or Hinge-which way does the door open?

Standing **OUTSIDE** the home, which side are the **HINGES** on? If they are on the **LEFT** side-You have a **LEFT HAND DOOR**. On the **RIGHT**? You have a **RIGHT HAND DOOR**

- **What is the right size?** There are 3 critical measurements-width, height, and if it is a combination door-jamb width (or thickness).

All Mobile Home door sizes are based on "rough opening" which is the size of the hole in the side of the home if the door was removed. Typically these numbers will be slightly larger than the "Call Size" of the door to allow the door to be shimmed to plumb and level. Example: If the door was removed and you measured the opening at 32 ½' wide and 76 ½" tall, you would order a 32" x 76" door. If you can't remove the door first, the best way is to remove the interior trim and measure the door WITH THE SIDE JAMBS and add ½" (.5") This will give you the call size for width and height. The actual door assembly (sometimes call the "buck size" will measure slightly smaller than the call size to allow for adjustments for plumb and level. (See chart on next page)

The last measurement is **jamb size**. Since the mobile home combination door has the main door and the storm door as a complete assembly, the door frame or jamb is included and must match the thickness of the wall of the home.

The thickness of the wall of the home varies with date of manufacture, the interior and exterior coverings, and the size of studs used in the wall construction. Earlier homes used homes with a 4" thick wall-these had metal siding, ¾" thick interior walls and nominal 2"x 4" studs. As manufacturers added vinyl siding and other exterior coverings and thicker interior wall coverings, walls grew to 4 ½" thick. Many modern homes now have 6" or even 6 ½" thick walls to take advantage of the greater strength and insulation of thicker walls.

## 3 EASY STEPS TO CHOOSE THE DOOR

<b>5140 Series Outswing Door</b>		
<b>Cell Size</b>	<b>Rough Opening</b>	<b>Buck size</b>
<b>Width x Height</b>	<b>Width x Height</b>	<b>Width x Height</b>
32" x 72"	32" x 72"	31.44" x 71.63"
32" x 74"	32" x 74"	31.44" x 73.63"
32" x 76"	32" x 76"	31.44" x 75.63"
32" x 78"	32" x 78"	31.44" x 77.63"
32" x 80"	32" x 80"	31.44" x 79.63"
34" x 76"	34" x 76"	33.44" x 75.63"
34" x 78"	34" x 78"	33.44" x 77.63"
34" x 80"	34" x 80"	33.44" x 79.63"
36" x 76"	36" x 76"	35.44" x 75.63"
36" x 80"	36" x 80"	35.44" x 79.63"
38" x 80"	38" x 80"	37.44" x 79.63"
<b>5210 Series Combination Door</b>		
<b>Cell Size</b>	<b>Rough Opening</b>	<b>Buck size</b>
<b>Width x Height</b>	<b>Width x Height</b>	<b>Width x Height</b>
32" x 76"	32" x 76"	31.44" x 75.63"
34" x 76"	34" x 76"	33.44" x 75.63"
34" x 78"	34" x 78"	33.44" x 77.63"
34" x 80"	34" x 80"	33.44" x 79.63"
36" x 76"	36" x 76"	35.44" x 75.63"
36" x 80"	36" x 80"	35.44" x 79.63"
38" x 76"	38" x 76"	37.44" x 75.63"
38" x 80"	38" x 80"	37.44" x 79.63"
<b>7660 Series Combination Door</b>		
<b>Cell Size</b>	<b>Rough Opening</b>	<b>Buck size</b>
<b>Width x Height</b>	<b>Width x Height</b>	<b>Width x Height</b>
32" x 76"	32" x 76"	31.44" x 75.63"
34" x 76"	34" x 76"	33.44" x 75.63"
34" x 78"	34" x 78"	33.44" x 77.63"
34" x 80"	34" x 80"	33.44" x 79.63"
36" x 76"	36" x 76"	35.44" x 75.63"
36" x 80"	36" x 80"	35.44" x 79.63"
38" x 76"	38" x 76"	37.44" x 75.63"
38" x 80"	38" x 80"	37.44" x 79.63"



---

---

## **FLANGE MOUNTING SYSTEM DOOR INSTALLATION FOR MANUFACTURED HOUSING**

Correct installation of the Kinro Manufactured Housing Door is essential for proper function. Improper installation will void the limited warranty.

Please read all instructions completely prior to door installation.

1. The following directions represent the proper installation of the Kinro doors. These directions do not indicate the only method of installation; however, acceptable methods of alternate installation will be considered the sole responsibility of the housing manufacturer.

2. All personal protective equipment, i.e. safety glasses, gloves, steel-toed boots or shoes, should be worn during the installation of the Kinro door.

### **WARNING!**

Due to the weight of the Kinro door products, proper lifting is required. Please use a reasonable amount of people with the required abilities to lift, carry and install the Kinro door assembly.

The safety directions in this manual are not intended to provide answers for all contingencies. It is the responsibility of the housing manufacturer to provide and implement all safety practices.

3. Kinro, Inc. does not warrant that all door products and directions provided comply with all applicable codes and regulations. The housing manufacturer is responsible for ensuring all components and installation methods used to build the housing conform with all codes and regulations.

4. Do not store doors in direct sunlight when stilled wrapped in delivery material.

### ***PREPARATION OF THE ROUGH OPENING***

1. The rough opening must be correctly sized and constructed. The rough opening is referred to by the door call size, e.g. 30" x 72" is rough opening of 30" wide by 72" high. The rough opening sill must be square to the floor with a allowance of  $\frac{1}{8}$ " or less across the entire width. If the rough opening sill is out of square by more than  $\frac{1}{8}$ " inch, shimming the door may be possible to square the door to the rough opening.

2. Be sure to confirm the square of the rough opening with diagonal measurements, see Fig. 2 on page H-5. The measurement between Fig. 1A and Fig. 1B must not exceed  $\frac{1}{4}$ ". The rough opening sill will need to be modified if the difference between the two diagonal measurements exceeds  $\frac{1}{4}$ ".

3. The rough opening must be inspected on the exterior face where the mounting flange of the door will make contact. There must be no gaps or open areas where the mounting flange will contact the rough opening. To completely and safely secure the door assembly, sheathing or other exterior wall material must be structurally sound.



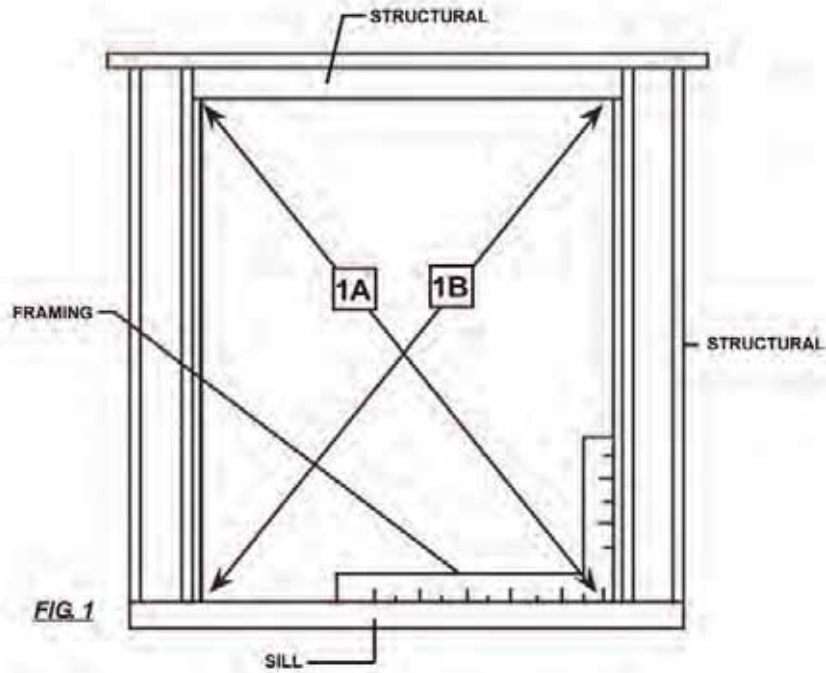

## DOOR INSPECTION AND PREPARATION

Terminology - Figure 2 gives all of the door terminology used in this manual.

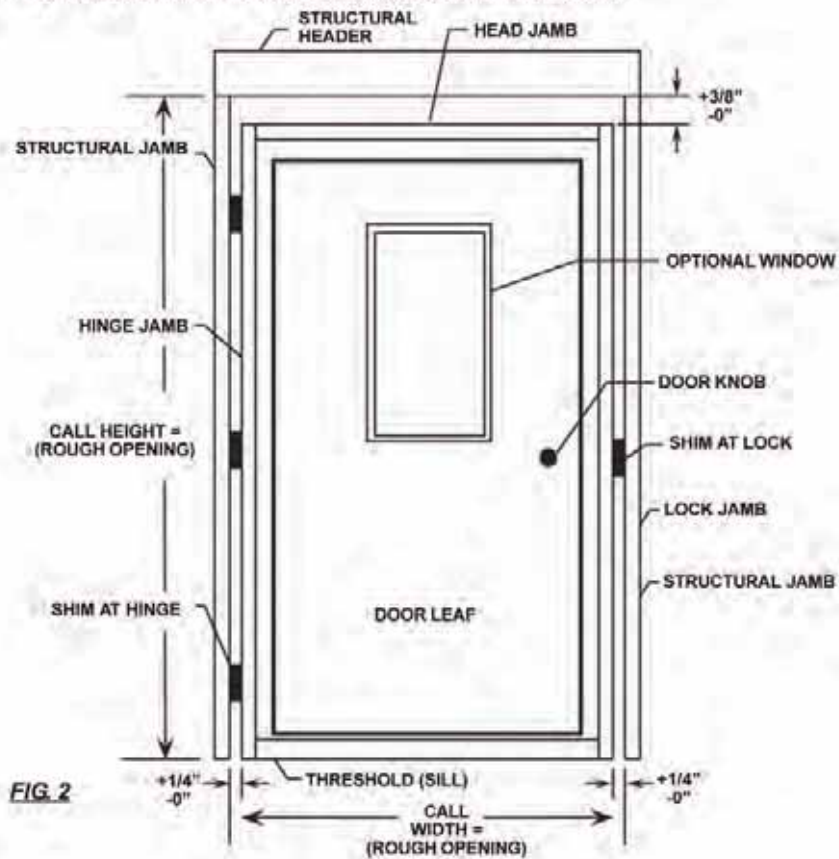

## DOORS & WINDOWS

1. Prior to installation, door must be measured to ensure it matches the rough opening call size, call width minus  $\frac{1}{2}$ " and call height minus  $\frac{3}{8}$ ".
2. Be sure to inspect mounting flanges to confirm they have not been damaged during shipping or handling. If the mounting flanges have been damaged or otherwise distorted, they will not lie flat against the exterior perimeter of the rough opening attempt to straighten the mounting flange or contact Kinro, Inc.
3. During the installation process, the door must remain closed at all times. Spacer blocks and or installation clips are installed in every Kinro door to assist when installing door by maintaining reveal between the frame and the door core until the door is completely installed.

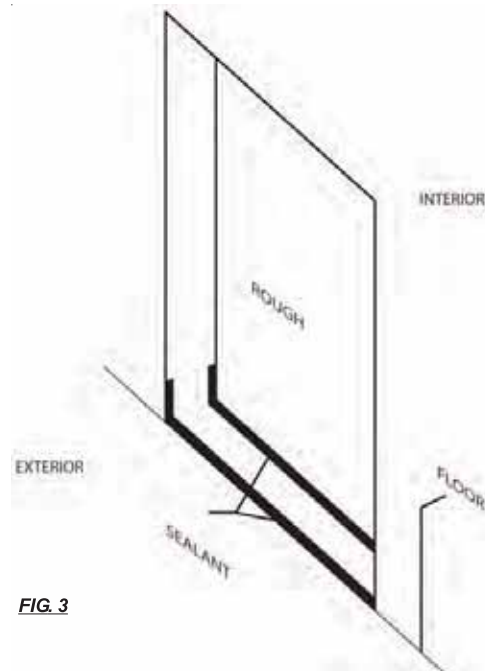

4. Apply sealant on the floor so the outside edges of the sill (both sides) will be sealed to the floor extending about 6" up the frame/jamb, see Fig. 3.
5. Apply sealant to the backside of the mounting flange, in line with the pre-punched holes.

### DOOR INSTALLATION

1. Place the door in the rough opening with the sill resting on the rough opening sill. If the rough opening sill is not square to the floor, remove the door and restructure the rough opening so that the sill is square.
2. Center the door from left to right, DO NOT remove the sill from contacting the rough opening sill. When installing doors, use corrosion resistant fasteners that produce a minimum of 1" of penetration into the framing members.

## WARNING!

While holding the door frame flat against the exterior of the wall, fasteners should be installed into both jambs and at the head. Install screws at the designated mounting locations making sure that there is at least 1" of penetration from the door jamb or head into the wall studs, see Fig. 4 for order of fastener install.

## WARNING!

Do not overdrive fasteners. Over driving fasteners will fracture or distort the mounting flange and compromise the seal. Do not apply fasteners or staples through any other surfaces of the door other than specified by Kinro designated areas or the mounting flange. Failure to comply may void any manufacturer's warranty.

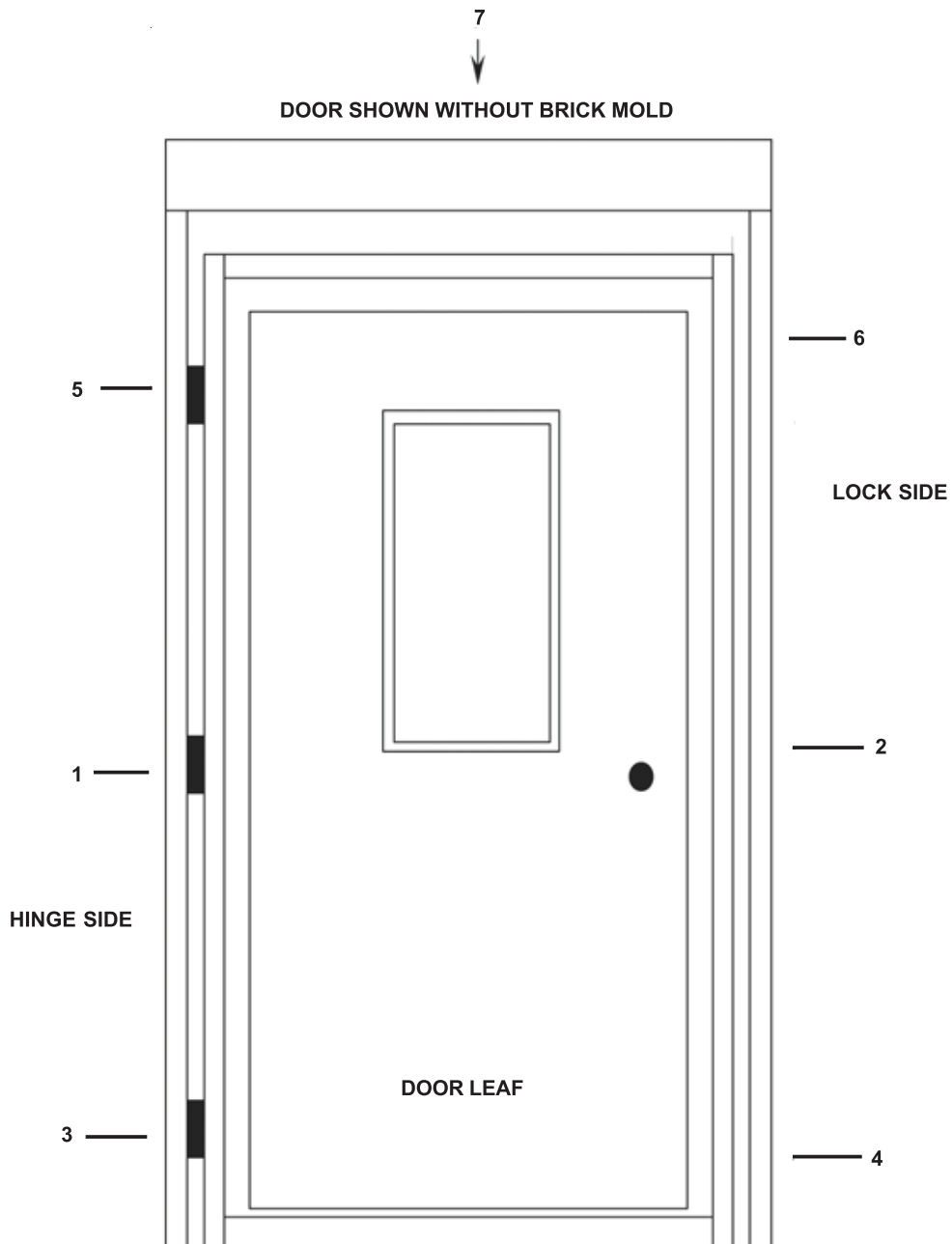

**FIG. 4**

3. Be sure to check the door frame a second time to confirm it is centered from side to side in the opening and the door frame members are straight and the door frame square. Measure opposite corners of the door frame in a manner similar to measuring the diagonals of the Rough Opening in Fig. 1. Allowance should be  $\frac{1}{8}$ " or smaller. If not, remove fasteners and re-install frame as per above directions.

**NOTE:** If scaffolding interferes with the top of the door, it is acceptable to install fasteners later when they are more accessible. Remove shipping blocks.

### **WARNING!**

Mounting flange is provided with pre-punched holes. Never leave holes or slots unsealed as moisture can penetrate and cause damage.

### **WARNING!**

Continue to install the rest of the fasteners starting in the center of each side of the door and progressing out to the corners. Fasteners must be installed in every hole to ensure the sealant on the back of the mounting flange makes full contact with the exterior perimeter of the rough opening.

4. From the interior of the house, place shims between the frame at the hinge locations into the frame/jamb and at the strike plate.

**NOTE:** Shims should only be used if there is a gap between the door jamb or the strike plate and sidewall studs. Do not force shims in.

**NOTE:** Shims should not be used at the frame head of a unit. If the rough opening header deflects, building loads will be transferred to the door causing improper operation or failure of door.

5. Open the door and install a fastener into all 3 mounting jamb hinges through the open hole in the center of each hinge. Additionally, screws of sufficient length to penetrate the structural member of the rough opening a minimum of 1" should be run through the jamb between the lock plate and the deadbolt strike plate.

6. Once the door is securely fastened in place, remove any pre-squaring clips and install any remaining door hardware so door opens and closes during testing for correct operation.

7. Add screw covers or brickmould over mounting fasteners if applicable.

8. Re-install shipping clips prior to transporting.

### **OPTIONAL INSTALLATION PROCEDURES**

**Insulation**—Insulate between the door frame and the interior of the rough opening at both jambs and at the head.

### **WARNING!**

Do not overpack insulation, as bowed frame/jambs may result. Expandable foam type material may bow frame as well, causing improper operation of the unit.

**Cleaning**—Do not use abrasive cleaners on the glass as they can permanently scratch or mar the surface. Any cleaners, other than mild detergent and a soft cloth should be tried in a corner of the door to check whether they actually damage the finish.

### **WARNING!**

Legged "J"-rail improperly installed may cause water or air to enter. Refer to the J-rail manufacturer for proper installation procedures. Failure to do may void the warranty, see Fig. 5. Weatherstripping, hardware components, tracks or vinyl components should not be painted or stained.

**Flashing**—Kinro recommends the use of flashing for proper moisture control. Refer to Section 21 (New Construction Installations) of the AAMA Installer Certification Manual.

# DOORS & WINDOWS

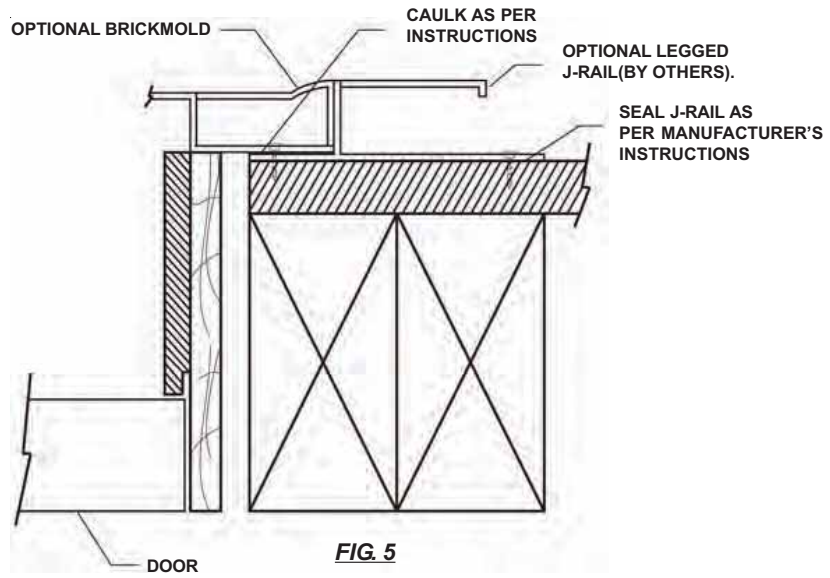

TYPICAL SECTION AT THE JAMB  
SHOWING POSSIBLE "J-RAIL" BY OTHERS

# DOORS & WINDOWS

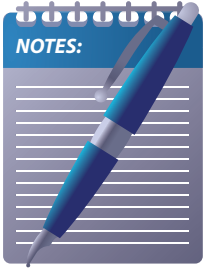

Four horizontal lines for writing notes, with a light yellow highlight on the top two lines.

Main body of the page containing 20 horizontal lines for writing notes, with alternating light yellow highlights on every second line.





## Series 7660 Six Panel House Type Steel Door

### Standard Features

- 25 gauge steel door core.
- Stainless steel lock system.
- Core is edge bored and capped for easy addition of dead bolt.
- Pre-finished white jamb system.
- Thermally broken threshold with rubber strip to prevent condensation and floor damage.
- Metal blind stop with residential style Q-Lon weatherstrip located on three sides.
- Four leaf sill sweep to stop drafts.
- Lockside metal blind stop and integral sealing system.
- Heavy duty aluminum framed storm door with stainless steel bushings in the hinges.
- Knocker/viewer standard (except oval).
- Manufactured to comply with
  - HUD Std. 3280-405
  - AAMA 1702.2.95
  - AAMA 1702.2.95



69350001 KINRO TOUCH-UP WHITE PAINT

*A totally efficient thermal entrance system. Completely pre-hung and ready to install, the 7660 includes a 25 gauge steel inner door and an energy efficient storm door.*

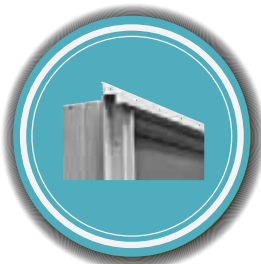

Door Frame Corner

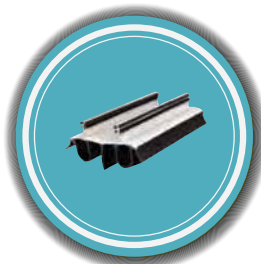

Sweep



Adjustable Blind Stop



6 Panel Solid Door

**NEW SIZES ADDED REGULARLY – CONTACT YOUR SALES REPRESENTATIVE**

## DOORS & WINDOWS

### KINRO SERIES 7660 HOUSE TYPE STEEL 6 PANEL DOOR WITHOUT WINDOW

Size W x H	DOOR DESCRIPTION	OPENING DIRECTION	WINDOW TYPE	STORM COLOR	STORM TYPE	JAMB SIZE	PART NUMBER
32" x 76"	RESIDENTIAL COMBO DOOR	LEFT HAND	N/A	WHITE	CONVENTIONAL	4"	69K23276LOWC0
		RIGHT HAND	N/A	WHITE	ALL GLASS	4"	69K23276R0WA0
			N/A	WHITE	CONVENTIONAL	4"	69K23276R0WC0
34" x 76"	RESIDENTIAL COMBO DOOR	LEFT HAND	N/A	WHITE	ALL GLASS	4"	69K23476LOWA0
			N/A	WHITE	CONVENTIONAL	4"	69K23476LOWC0
			N/A	WHITE	FULL VIEW	4"	69K23476LOWF0
			N/A	WHITE	CONVENTIONAL	6.5"	69K23476LOWC2
		RIGHT HAND	N/A	WHITE	ALL GLASS	4"	69K23476R0WA0
			N/A	WHITE	CONVENTIONAL	4"	69K23476R0WC0
			N/A	WHITE	FULL VIEW	4"	69K23476R0WF0
			N/A	WHITE	CONVENTIONAL	6.5"	69K23476R0WC2
38" x 76"	RESIDENTIAL COMBO DOOR	LEFT HAND	N/A	WHITE	CONVENTIONAL	4"	69K23876LOWC0
		RIGHT HAND	N/A	WHITE	CONVENTIONAL	4"	69K23876R0WC0
		LEFT HAND	N/A	WHITE	CONVENTIONAL	6.5"	69K23876LOWC2
		RIGHT HAND	N/A	WHITE	CONVENTIONAL	6.5"	69K23876R0WC2
34" x 78"	RESIDENTIAL COMBO DOOR	LEFT HAND	N/A	WHITE	CONVENTIONAL	4"	69K23478LOWC0
		RIGHT HAND	N/A	WHITE	CONVENTIONAL	4"	69K23478R0WC0
34" x 80"	RESIDENTIAL COMBO DOOR	LEFT HAND	N/A	WHITE	FULL VIEW	4"	69K23480LOWF0
			N/A	WHITE	CONVENTIONAL	4"	69K23480LOWC0
			N/A	WHITE	CONVENTIONAL	6.5"	69K23480LOWC2
		RIGHT HAND	N/A	WHITE	FULL VIEW	4"	69K23480R0WF0
			N/A	WHITE	CONVENTIONAL	4"	69K23480R0WC0
			N/A	WHITE	CONVENTIONAL	6.5"	69K23480R0WC2
36" x 76"	RESIDENTIAL COMBO DOOR	LEFT HAND	N/A	WHITE	ALL GLASS	4"	69K23676LOWA0
		RIGHT HAND	N/A	WHITE	ALL GLASS	4"	69K23676R0WA0
36" x 80"	RESIDENTIAL COMBO DOOR	LEFT HAND	N/A	WHITE	ALL GLASS	4"	69K23680LOWA0
		RIGHT HAND	N/A	WHITE	ALL GLASS	4"	69K23680R0WA0
		LEFT HAND	N/A	WHITE	CONVENTIONAL	4"	69K23680LOWC0
		RIGHT HAND	N/A	WHITE	CONVENTIONAL	4"	69K23680R0WC0
38" x 80"	RESIDENTIAL COMBO DOOR	LEFT HAND	N/A	WHITE	CONVENTIONAL	4"	69K23880LOWC0
		LEFT HAND	N/A	WHITE	CONVENTIONAL	6.5"	69K23880LOWC2
		RIGHT HAND	N/A	WHITE	CONVENTIONAL	4"	69K23880R0WC0
		RIGHT HAND	N/A	WHITE	CONVENTIONAL	6.5"	69K23880R0WC2
		LEFT HAND	N/A	WHITE	ALL GLASS	4"	69K23880LOWA0
		RIGHT HAND	N/A	WHITE	ALL GLASS	4"	69K23880R0WA0
38" x 82"	RESIDENTIAL COMBO DOOR	LEFT HAND	N/A	WHITE	ALL GLASS	4"	69K23882LOWA0
		RIGHT HAND	N/A	WHITE	ALL GLASS	4"	69K23882R0WA0

#### STORM DOOR STYLES



*All Glass*



*Conventional*



*Full View*





## Series 7660 Cottage House Type Steel Door

### Standard Features

- 25 gauge steel door core.
- Stainless steel lock system.
- Core is edge bored and capped for easy addition of dead bolt.
- Pre-finished white jamb system.
- Thermally broken threshold with rubber strip to prevent condensation and floor damage.
- Metal blind stop with residential style Q-Lon weatherstrip located on three sides.
- Four leaf sill sweep to stop drafts.
- Lockside metal blind stop and integral sealing system.
- Heavy duty aluminum framed storm door with stainless steel bushings in the hinges with built-in drip cap.
- Manufactured to comply with
  - HUD Std. 3280-405
  - AAMA 1702.2.95
  - AAMA 1702.2.95



69350001 KINRO TOUCH-UP WHITE PAINT

*A totally efficient thermal entrance system. Completely pre-hung and ready to install, the 7660 includes a 25 gauge steel inner door and an energy efficient storm door.*



Door Frame Corner

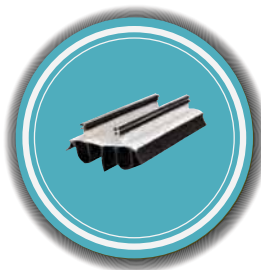

Sweep



Blind Stop



9 Pane Cottage Window

NEW SIZES ADDED REGULARLY – CONTACT YOUR SALES REPRESENTATIVE

## DOORS & WINDOWS

### KINRO SERIES 7660 HOUSE TYPE STEEL DOOR WITH COTTAGE WINDOW

Size W x H	DOOR DESCRIPTION	OPENING DIRECTION	WINDOW TYPE	STORM COLOR	STORM TYPE	JAMB SIZE	PART NUMBER	
34" x 76"	RESIDENTIAL COMBO DOOR	LEFT HAND	COTTAGE	WHITE	CONVENTIONAL	4"	69K23476L4WC0	
							6 ½"	69K23476L4WC2
			COTTAGE IG			4"	69K23476L8WC0	
						6 ½"	69K23476L8WC2	
		RIGHT HAND	COTTAGE	WHITE	CONVENTIONAL	4"	69K23476R4WC0	
							6 ½"	69K23476R4WC2
			COTTAGE IG			6 ½"	69K23476R8WC2	
						4"	69K23476R8WC0	
34" x 80"	RESIDENTIAL COMBO DOOR	LEFT HAND	COTTAGE	WHITE	CONVENTIONAL	4"	69K23480L4WC0	
							6 ½"	69K23480L4WC2
		RIGHT HAND	COTTAGE			CONVENTIONAL	4"	69K23480R4WC0
								6 ½"

### STORM DOOR STYLES



*Conventional*



## Series 7660 Sunburst House Type Steel Door

### Standard Features

- 25 gauge steel door core.
- Stainless steel lock system.
- Core is edge bored and capped for easy addition of dead bolt.
- Pre-finished white jamb system.
- Thermally broken threshold with rubber strip to prevent condensation and floor damage.
- Metal blind stop with residential style Q-Lon weatherstrip located on three sides.
- Four leaf sill sweep to stop drafts.
- Lockside metal blind stop and integral sealing system.
- Heavy duty aluminum framed storm door with stainless steel bushings in the hinges and built-in drip cap.
- Manufactured to comply with
  - HUD Std. 3280-405
  - AAMA 1702.2.95
  - AAMA 1702.2.95



*A totally efficient thermal entrance system. Completely pre-hung and ready to install, the 7660 includes a 25 gauge steel inner door and an energy efficient storm door.*



69350001 KINRO TOUCH-UP WHITE PAINT



Door Frame Corner

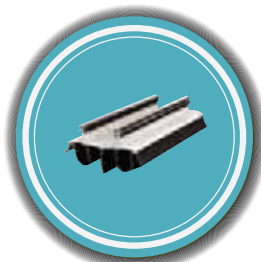

Sweep



Blind Stop



Sunburst Window

NEW SIZES ADDED REGULARLY – CONTACT YOUR SALES REPRESENTATIVE





## Series 7660 Full Oval House Type Steel Door

### Standard Features

- 25 gauge steel door core.
- Stainless steel lock system.
- Core is edge bored and capped for easy addition of dead bolt.
- Pre-finished white jamb system.
- Thermally broken threshold with rubber strip to prevent condensation and floor damage.
- Metal blind stop with residential style Q-Lon weatherstrip located on three sides.
- Four leaf sill sweep to stop drafts.
- Lockside metal blind stop and integral sealing system.
- Heavy duty aluminum framed storm door with stainless steel bushings in the hinges and built-in drip cap.
- Manufactured to comply with
  - HUD Std. 3280-405
  - AAMA 1702.2.95
  - AAMA 1702.2.95



69350001 KINRO TOUCH-UP WHITE PAINT

*A totally efficient thermal entrance system. Completely pre-hung and ready to install, the 7660 includes a 25 gauge steel inner door and an energy efficient storm door.*



Door Frame Corner

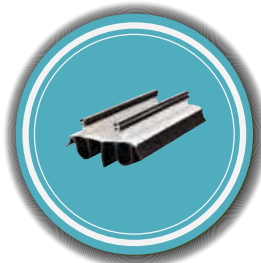

Sweep



Blind Stop



Bevel and Frosted Glass

NEW SIZES ADDED REGULARLY – CONTACT YOUR SALES REPRESENTATIVE

Product Availability, Prices and Specifications Subject to Change without Notice

**KINRO SERIES 7660 HOUSE TYPE STEEL DOOR WITH BRASS FULL OVAL WINDOW**

Size W x H	DOOR DESCRIPTION	OPENING DIRECTION	WINDOW TYPE	STORM COLOR	STORM TYPE	JAMB SIZE	PART NUMBER
34" x 76"	RESIDENTIAL COMBO DOOR	LEFT HAND	OVAL	WHITE	ALL GLASS	4"	69K23476L6WA0
		RIGHT HAND				4"	69K23476R6WA0

**STORM DOOR STYLES**

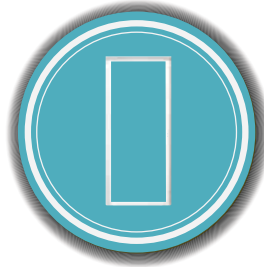

*All Glass*

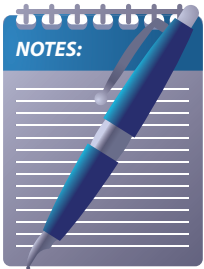

A series of horizontal lines for taking notes, including a shaded yellow area for the first few lines.



## Series 5210 Inswing Combination

### Standard Features

- Galvanized steel frame which is pre-cambered on the lock side to promote a tight seal.
- Three heavy duty hinges join the core to the frame.
- Heavy, damage resistant panels are securely bonded to the core.
- Effective insulated 2 pound density foam core.
- 5 pound density foam lock block won't distort or deteriorate.
- Thermally broken threshold with rubber strip to prevent condensation and floor damage.
- Core is edge bored and capped for easy addition of dead bolt
- Residential style butt hinges used to mount inswinging core.
- Lockside metal blind stop and integral sealing system.
- Pre-finished jamb system.
- Double leaf sill sweep to stop drafts.
- Stainless steel lock system with adjustable strike plate.
- Self-storing heavy duty aluminum framed storm door with stainless steel bushings in the hinges and built-in drip cap.
- Manufactured to comply with
  - HUD Std. 3280-405
  - AAMA 1702.2.95
  - AAMA 1702.2.95



69350001 KINRO TOUCH-UP WHITE PAINT



**An efficient thermal entrance system for manufactured housing. Completely pre-hung and ready to install, the 5210 includes a tough fiberglass-clad inner door and an energy efficient storm door.**



5210 Door Sweep



5210 Door Stop

NEW SIZES ADDED REGULARLY – CONTACT YOUR SALES REPRESENTATIVE

## DOORS & WINDOWS

### KINRO SERIES 5210 INSWING COMBINATION DOOR

Size W x H	DOOR DESCRIP- TION	OPENING DIRECTION	WINDOW TYPE	STORM COLOR	STORM TYPE	JAMB SIZE	PART NUMBER
32" x 76"	INSWING COMBO DOOR	LEFT HAND	10 x 10	MILL	CONVENTIONAL	4"	69K73276L1MCO
				WHITE	CONVENTIONAL	4"	69K73276L1WCO
		RIGHT HAND		MILL	CONVENTIONAL	4"	69K73276R1MCO
				WHITE	CONVENTIONAL	4"	69K73276R1WCO
34" x 76"	INSWING COMBO DOOR	LEFT HAND	10 x 10	MILL	CONVENTIONAL	4"	69K73476L1MCO
				WHITE	CONVENTIONAL	4"	69K73476L1WCO
				WHITE	CONVENTIONAL	6 ½"	69K73476L1WC2
				COTTAGE	CONVENTIONAL	6 ½"	69K73476L4WC2
		RIGHT HAND	10 x 10	MILL	CONVENTIONAL	4"	69K73476R1MCO
				WHITE	CONVENTIONAL	4"	69K73476R1WCO
				WHITE	CONVENTIONAL	6 ½"	69K73476R1WC2
				WHITE	CONVENTIONAL	6 ½"	69K73476R4WC2
34" x 78"	INSWING COMBO DOOR	LEFT HAND	10 x 10	MILL	CONVENTIONAL	4"	69K73478L1MCO
			10 x 10	WHITE	CONVENTIONAL	4"	69K73478L1WCO
		RIGHT HAND	10 x 10	MILL	CONVENTIONAL	4"	69K73478R1MCO
			10 x 10	WHITE	CONVENTIONAL	4"	69K73478R1WCO
34" x 80"	INSWING COMBO DOOR	LEFT HAND	10 x 10	MILL	CONVENTIONAL	4"	69K73480L1MCO
			10 x 10	WHITE	CONVENTIONAL	4"	69K73480L1WCO
			COTTAGE	CONVENTIONAL	6 ½"	69K73480L4WC2	
		RIGHT HAND	10 x 10	MILL	CONVENTIONAL	4"	69K73480R1MCO
			10 x 10	WHITE	CONVENTIONAL	4"	69K73480R1WCO
			COTTAGE	CONVENTIONAL	6 ½"	69K73480R4WC2	
36" x 76"	INSWING COMBO DOOR	LEFT HAND	10 x 10	WHITE	CONVENTIONAL	4"	69K73676L1WCO
		RIGHT HAND	10 x 10	WHITE	CONVENTIONAL	4"	69K73676R1WCO
36" x 80"	INSWING COMBO DOOR	LEFT HAND	10 x 10	WHITE	CONVENTIONAL	4"	69K73680L1WCO
		RIGHT HAND	10 x 10	WHITE	CONVENTIONAL	4"	69K73680R1WCO
38" x 76"	INSWING COMBO DOOR	LEFT HAND	10 x 10	WHITE	CONVENTIONAL	4"	69K73876L1WCO
		RIGHT HAND	10 x 10	WHITE	CONVENTIONAL	4"	69K73876R1WCO
38" x 80"	INSWING COMBO DOOR	LEFT HAND	10 x 10	WHITE	CONVENTIONAL	4"	69K73880L1WCO
		RIGHT HAND	10 x 10	WHITE	CONVENTIONAL	4"	69K73880R1WCO

### STORM DOOR STYLES



*All Glass*



*Conventional*



*Full View*

Product Availability, Prices and Specifications Subject to Change without Notice





## Outswing Door Series 5140

### Standard Features

- Strong welded aluminum frame with integral weather baffle.
- Three heavy duty hinges join the core to the frame.
- Heavy, damage resistant panels are securely bonded to the core.
- Effective insulated 2 pound density foam core.
- 5 pound density foam lock block won't distort or deteriorate
- Core is edge bored and capped for easy addition of dead bolt
- Bulb vinyl on all four sides form the primary sealing system. Extruded flap vinyl on all four sides of the frame form the secondary seal.
- Manufactured to comply with
  - HUD Std. 3280-405
  - AAMA 1702.2.95
  - AAMA 1702.2.95
- Painted frame option available.



*An outswing entrance door that combines beauty, durability, and efficiency. It is completely pre-hung and ready to install. The 5140 also has a flat mounting flange.*

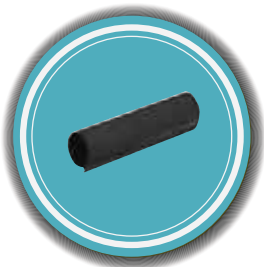

5140 Bulb Seal

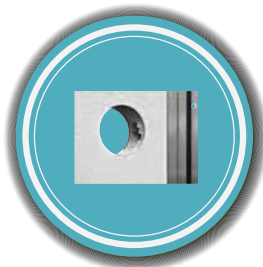

Predrilled For Lockset



Polyethylene Door Skin



High Density Foam Lock Block

**NEW SIZES ADDED REGULARLY – CONTACT YOUR SALES REPRESENTATIVE**

## DOORS & WINDOWS

### KINRO SERIES 5140 OUTSWING DOOR

Size W x H	DOOR DESCRIPTION	OPENING DIRECTION	WINDOW TYPE	JAMB SIZE	PART NUMBER
32" x 72"	OUTSWING DOOR	LEFT HAND	N/A	4"	69K43272LONNO
			10 x 10	4"	69K43272L1NNO
			14 x 27	4"	69K43272L3NNO
		RIGHT HAND	NONE	4"	69K43272RONNO
			10 x 10	4"	69K43272R1NNO
			14 x 27	4"	69K43272R3NNO
32" x 74"	OUTSWING DOOR	LEFT HAND	N/A	4"	69K43274LONNO
			14 x 27	4"	69K43274L3NNO
		RIGHT HAND	NONE	4"	69K43274RONNO
			14 x 27	4"	69K43274R3NNO
32" x 76"	OUTSWING DOOR	LEFT HAND	N/A	4"	69K43276LONNO
			10 x 10	4"	69K43276L1NNO
			14 x 27	4"	69K43276L3NNO
			COTTAGE	4"	69K43276L4NNO
		RIGHT HAND	N/A	4"	69K43276RONNO
			10 x 10	4"	69K43276R1NNO
			14 x 27	4"	69K43276R3NNO
			COTTAGE	4"	69K43276R4NNO
32" x 78"	OUTSWING DOOR	LEFT HAND	10 x 10	4"	69K43278L1NNO
			14 x 27	4"	69K43278L3NNO
		RIGHT HAND	10 x 10	4"	69K43278R1NNO
			14 x 27	4"	69K43278R3NNO
34" x 76"	OUTSWING DOOR	LEFT HAND	N/A	4"	69K43476LONNO
			10 x 10	4"	69K43476L1NNO
			14 x 27	4"	69K43476L3NNO
			COTTAGE	4"	69K43476L4NNO
		RIGHT HAND	N/A	4"	69K43476RONNO
			10 x 10	4"	69K43476R1NNO
			14 x 27	4"	69K43476R3NNO
			COTTAGE	4"	69K43476R4NNO
34" x 78"	OUTSWING DOOR	LEFT HAND	10 x 10	4"	69K43478L1NNO
		RIGHT HAND	10 x 10	4"	69K43478R1NNO
34" x 80"	OUTSWING DOOR	LEFT HAND	10 x 10	4"	69K43480L1NNO
		RIGHT HAND	10 X 10	4"	69K43480R1NNO
36" x 76"	OUTSWING DOOR	LEFT HAND	N/A	4"	69K43676LONNO
			10 x 10	4"	69K43676L1NNO
		RIGHT HAND	N/A	4"	69K43676RONNO
			10 x 10	4"	69K43676R1NNO
36" x 80"	OUTSWING DOOR	LEFT HAND	N/A	4"	69K43680LONNO
			10 x 10	4"	69K43680L1NNO
			14 x 27	4"	69K43680L3NNO
		RIGHT HAND	N/A	4"	69K43680RONNO
			10 x 10	4"	69K43680R1NNO
			14 x 27	4"	69K43680R3NNO



## Outswing Entry Steel Door Series 5500

### Standard Features

- White painted galvanized steel mounting frame
- 1 3/8" door thickness
- Core is edged bored, capped and face drilled for dead bolt
- Cottage style (9 light) window option available
- Full perimeter compression gaskets and seals
- 6-Panel design
- Polystyrene foam core insulation
- 4 extruded hinges with bushings
- Manufactured to comply with HUD Std. 3280-405



*A totally efficient thermal entrance system  
Completely pre-hung and ready to install*



1 3/8" Door Thickness

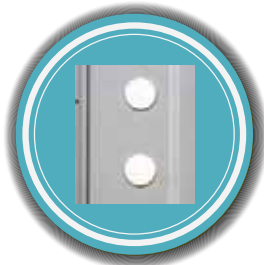

Predrilled For Lockset



Polystyrene Foam Core Insulation



9 Pane Cottage Window

NEW SIZES ADDED REGULARLY – CONTACT YOUR SALES REPRESENTATIVE

**KINRO SERIES 5500 OUTSWING STEEL ENTRY DOOR**

Size W x H	DOOR DESCRIPTION	OPENING DIRECTION	WINDOW TYPE	JAMB SIZE	PART NUMBER
32" x 72"	OUTSWING DOOR	LEFT HAND	N/A	4"	69K63272LONNO
			COTTAGE	4"	69K63272L4NNO
		RIGHT HAND	N/A	4"	69K63272RONNO
			COTTAGE	4"	69K63272R4NNO
32" x 76"	OUTSWING DOOR	LEFT HAND	N/A	4"	69K63276LONNO
			COTTAGE	4"	69K63276L4NNO
		RIGHT HAND	N/A	4"	69K63276RONNO
			COTTAGE	4"	69K63276R4NNO
34" x 76"	OUTSWING DOOR	LEFT HAND	N/A	4"	69K63476LONNO
			COTTAGE	4"	69K63476L4NNO
		RIGHT HAND	N/A	4"	69K63476RONNO
			COTTAGE	4"	69K63476R4NNO
34" x 80"	OUTSWING DOOR	LEFT HAND	N/A	4"	69K63480LONNO
			COTTAGE	4"	69K63480L4NNO
		RIGHT HAND	N/A	4"	69K63480RONNO
			COTTAGE	4"	69K63480R4NNO
36" x 76"	OUTSWING DOOR	LEFT HAND	N/A	4"	69K63676LONNO
			COTTAGE	4"	69K63676L4NNO
36" x 80"	OUTSWING DOOR	LEFT HAND	N/A	4"	69K63680LONNO



6 PANEL OUTSWING DOOR



COTTAGE OUTSWING DOOR



## Outswing Utility Door Series 5140

### Standard Features

- Strong welded aluminum frame with integral weather baffle.
- Three heavy duty hinges join the core to the frame.
- Heavy, damage resistant panels are securely bonded to the core.
- Effective insulated 2 pound density foam core.
- 5 pound density foam lock block won't distort or deteriorate
- Core is edge bored and capped for easy addition of dead bolt
- Bulb vinyl on all four sides form the primary sealing system. Extruded flap vinyl on all four sides of the frame form the secondary seal.
- Manufactured to comply with
  - HUD Std. 3280-405
  - AAMA 1702.2.95
  - AAMA 1702.2.95
- Painted frame option available.



*An outswing entrance door that combines beauty, durability, and efficiency. It is completely pre-hung and ready to install. The 5140 also has a flat mounting flange.*

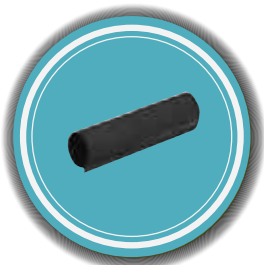

5140 Bulb Seal

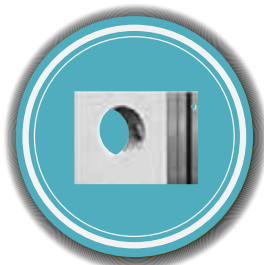

Predrilled For Lockset



Polyethylene Door Skin



High Density Foam Lock Block

**NEW SIZES ADDED REGULARLY – CONTACT YOUR SALES REPRESENTATIVE**





## 5600 Series Storm Door

### Standard Features

- Integral Z-bar drip cap.
- Full length galvanized hinge pin with stainless steel bushings.
- Safety glass
- Fiberglass screening
- Top quality hardware
- Heavy duty kick plate

### Available sizes:

- 32" x 76"
- 34" x 76"
- 34" x 78"
- 34" x 80"
- 36" x 76"
- 36" x 80"
- 38" x 76"
- 38" x 80"

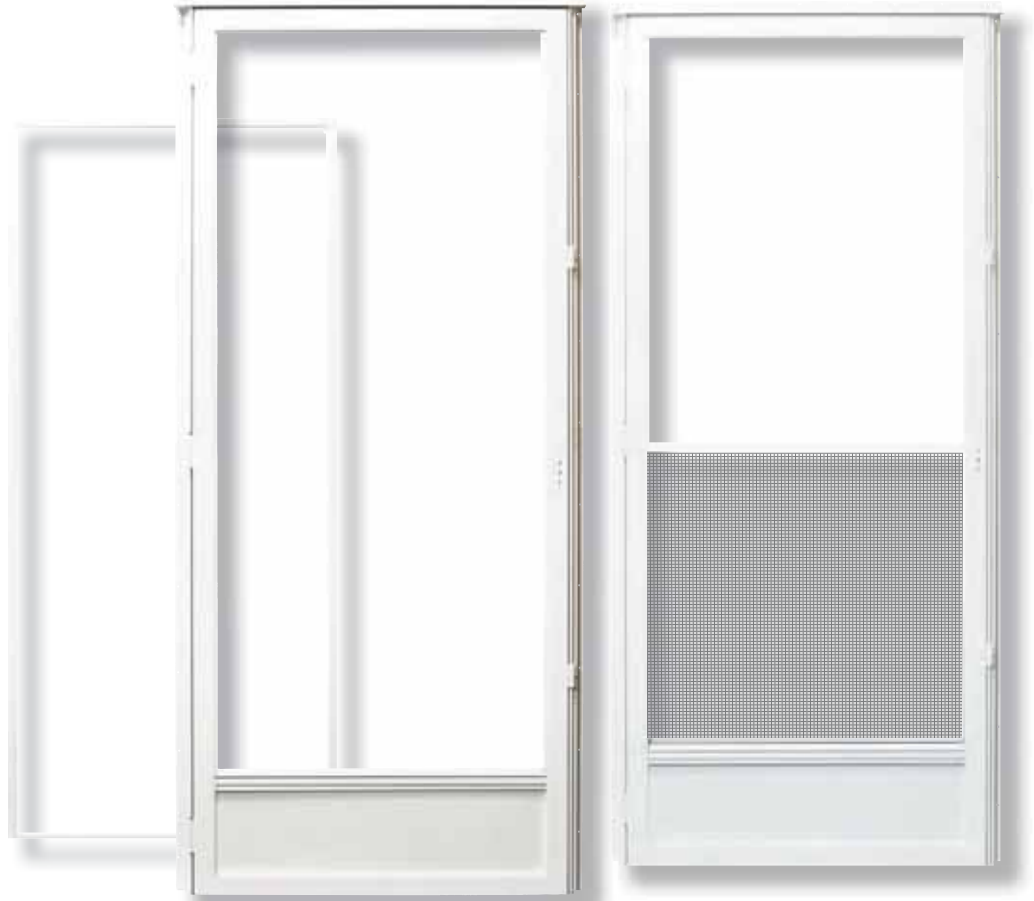

FULL VIEW STORM DOOR WITH REMOVABLE GLASS

CONVENTIONAL STORM DOOR



Integral Z-bar Drip Cap



Predrilled For Door Latch

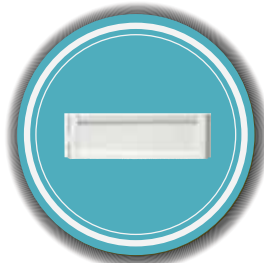

Heavy Duty Kickplate

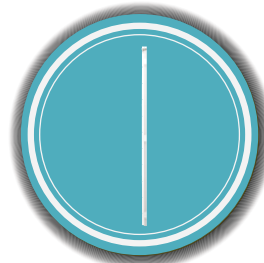

Full Length Galvanized Hinge Pin  
With Stainless Steel Bushings

NEW SIZES ADDED REGULARLY – CONTACT YOUR SALES REPRESENTATIVE

Product Availability, Prices and Specifications Subject to Change without Notice

KINRO SERIES 5600 STORM DOOR					
Size W x H	DOOR DESCRIPTION	OPENING DIRECTION	COLOR	WINDOW TYPE	PART NUMBER
32" x 76"	STORM DOOR	LEFT HAND	WHITE	CONVENTIONAL	69K83276LOWC0
		RIGHT HAND	WHITE	CONVENTIONAL	69K83276R0WC0
34" x 76"	STORM DOOR	LEFT HAND	MILL	CONVENTIONAL	69K83476L0MC0
			WHITE	CONVENTIONAL	69K83476LOWC0
			WHITE	FULL VIEW	69K83476LOWF0
			WHITE	ALL GLASS	69K83476LOWA0
		RIGHT HAND	MILL	CONVENTIONAL	69K83476R0MC0
			WHITE	CONVENTIONAL	69K83476R0WC0
			WHITE	FULL VIEW	69K83476R0WF0
			WHITE	ALL GLASS	69K83476R0WA0
34" x 78"	STORM DOOR	LEFT HAND	WHITE	CONVENTIONAL	69K83478LOWC0
		RIGHT HAND	WHITE	CONVENTIONAL	69K83478R0WC0
34" x 80"	STORM DOOR	LEFT HAND	WHITE	CONVENTIONAL	69K83480LOWC0
		RIGHT HAND	WHITE	CONVENTIONAL	69K83480R0WC0
36" x 76"	STORM DOOR	LEFT HAND	WHITE	CONVENTIONAL	69K83676LOWC0
		RIGHT HAND	WHITE	CONVENTIONAL	69K83676R0WC0
36" x 80"	STORM DOOR	LEFT HAND	WHITE	CONVENTIONAL	69K83680LOWC0
		RIGHT HAND	WHITE	CONVENTIONAL	69K83680R0WC0
38" x 76"	STORM DOOR	LEFT HAND	WHITE	CONVENTIONAL	69K83876LOWC0
		RIGHT HAND	WHITE	CONVENTIONAL	69K83876R0WC0
38" x 80"	STORM DOOR	LEFT HAND	WHITE	CONVENTIONAL	69K83880LOWC0
		RIGHT HAND	WHITE	CONVENTIONAL	69K83880R0WC0

**STORM DOOR STYLES**



*34" x 76" Storm Door  
with Conventional Window  
Also Available In Mill Finish*

*Conventional*

*Full View*





## 5900 Series Heavy Duty Storm Door

### Standard Features

- Full view 1 ¼" thick storm door
- Designed to fit Kinro 7660 & 5210 Entry Doors
- Wide frame on storm leaf lip profile
- Lip profile overlaps Z-bar
- Full-length galvanized hinge pin features stainless steel bushings
- Safety glass
- Rolled in fiberglass screening
- Top-quality hardware
- Heavy-duty kick plate

Available sizes:

- 34" x 76"
- 34" x 80"
- 38" x 76"

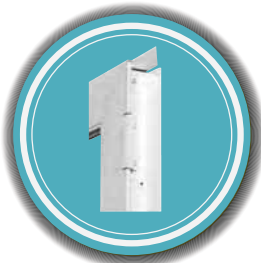
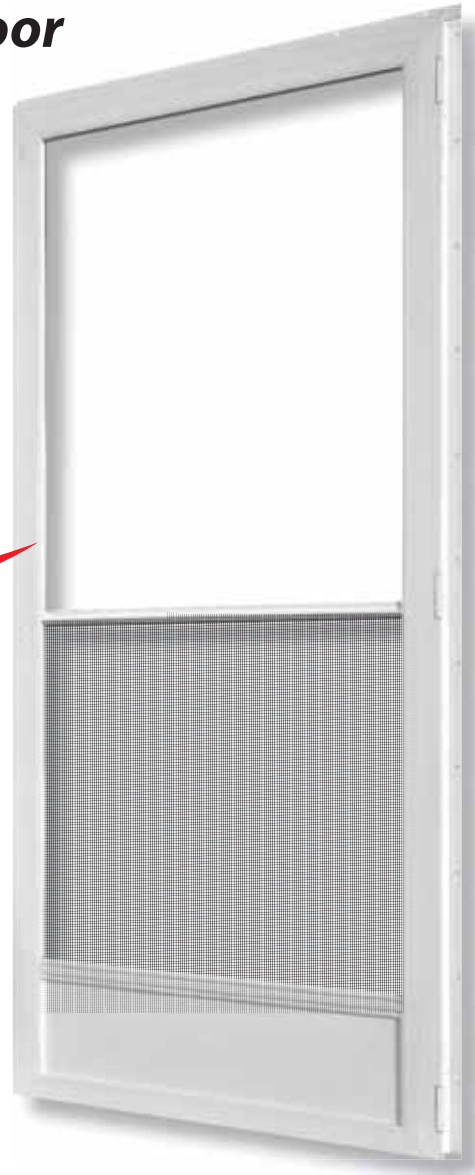

1 ¼" Door Thickness

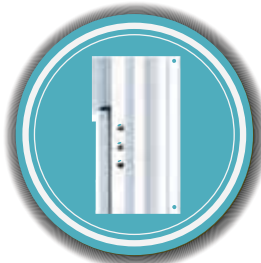

Predrilled For Door Latch



Heavy Duty Kickplate

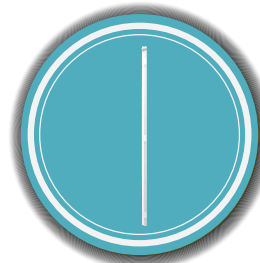

Full Length Galvanized Hinge Pin  
With Stainless Steel Bushings

NEW SIZES ADDED REGULARLY – CONTACT YOUR SALES REPRESENTATIVE

Product Availability, Prices and Specifications Subject to Change without Notice

**KINRO SERIES 5900 HEAVY DUTY STORM DOOR**

Size W x H	DOOR DESCRIPTION	OPENING DIRECTION	COLOR	WINDOW TYPE	PART NUMBER
34" x 76"	STORM DOOR	LEFT HAND	WHITE	CONVENTIONAL	69K83476LOWCH
		RIGHT HAND	WHITE	CONVENTIONAL	69K83476ROWCH
34" x 80"	STORM DOOR	LEFT HAND	WHITE	CONVENTIONAL	69K83480LOWCH
		RIGHT HAND	WHITE	CONVENTIONAL	69K83480ROWCH
38" x 76"	STORM DOOR	LEFT HAND	WHITE	CONVENTIONAL	69K83876LOWCH
		RIGHT HAND	WHITE	CONVENTIONAL	69K83876ROWCH

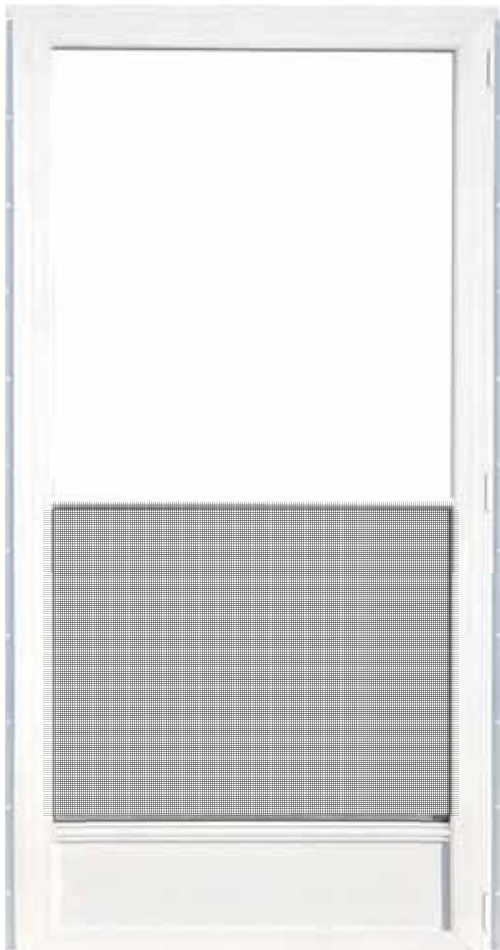

5900 HEAVY DUTY STORM DOOR OUTSIDE VIEW

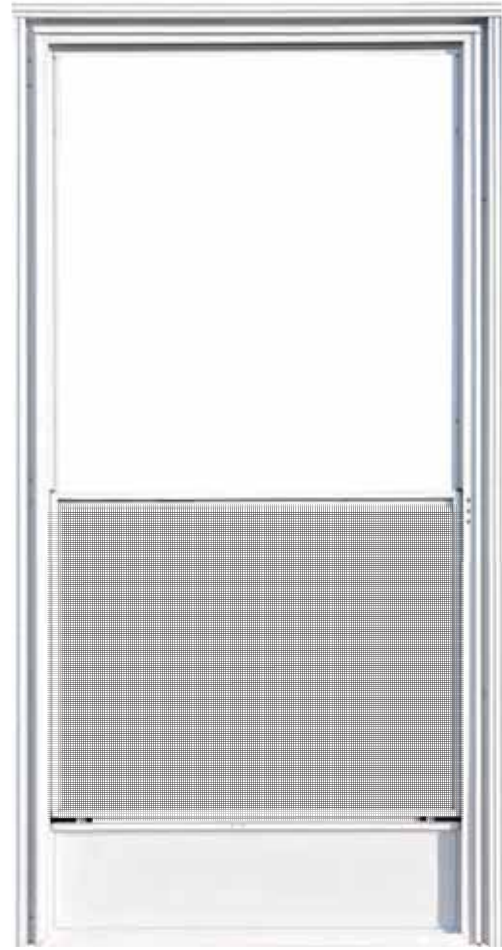

5900 HEAVY DUTY STORM DOOR INSIDE VIEW

# Kinro<sup>®</sup> Mobile Home Window Measuring Guide



There are several factors to help determine that the correct Kinro window is selected:

- **Type—does the customer need a:**

- ☑ **Flush mounted vertical sliding aluminum main window**—This window is made with an aluminum frame, mounts directly to the outside of the home, has a fixed upper sash, a lower sliding sash that slides vertically and a built in screen in the lower section. This was the original window used in early mobile homes and RV's and is still seen in some newer units. A low cost option for light and ventilation. This is an 18000 Series window.

- ☑ **Flush mounted horizontal sliding aluminum main window**— This window is made with an aluminum frame, mounts directly to the outside of the home, has one fixed and one horizontal sliding sash. Not widely used, it is available in limited sizes. This is a 19000 Series window.

- ☑ **Self-storing inside storm window**—This window provides improved sealing and energy efficiency when added to the flush mounted window (see 18000 / 19000 Series above). This window mounts to the inside of the window opening, has a white frame and sash and moveable lower sash. This is a 5700 Series storm window.

- ☑ **Vinyl windows**—These windows have much higher energy efficiency. Built with a removable siding channel, these windows mount to the exterior of the home and feature double paned insulating glass and a built in screen in the lower section. The lower main sash slides up for ventilation, and can be tilted in for easier cleaning of the outside lower glass. This is a 9750 Series window.

- **What is the right size?** There are two critical measurements, width and height. Mobile home sized windows are based on "call size". The rough opening is typically ¼"– ½" larger in width and height to allow for adjustment to achieve setting the windows plumb in the opening. The charts on next page help identify the call size.

- **How to measure a window:** Measure the width and height of the part of the window that fits into the opening in the home (see illustration on next page).

# Window Measuring Guide

**Kimco** 18000 / 19000 SERIES

**Kimco** 9750 SERIES

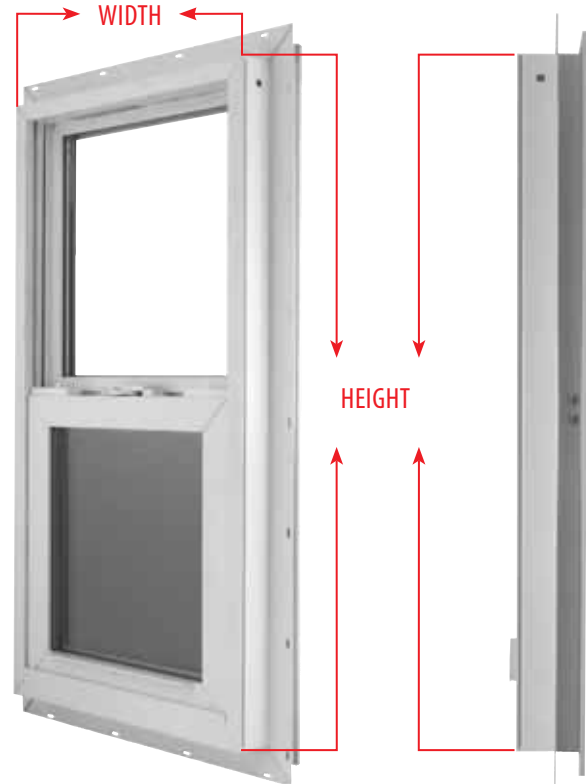
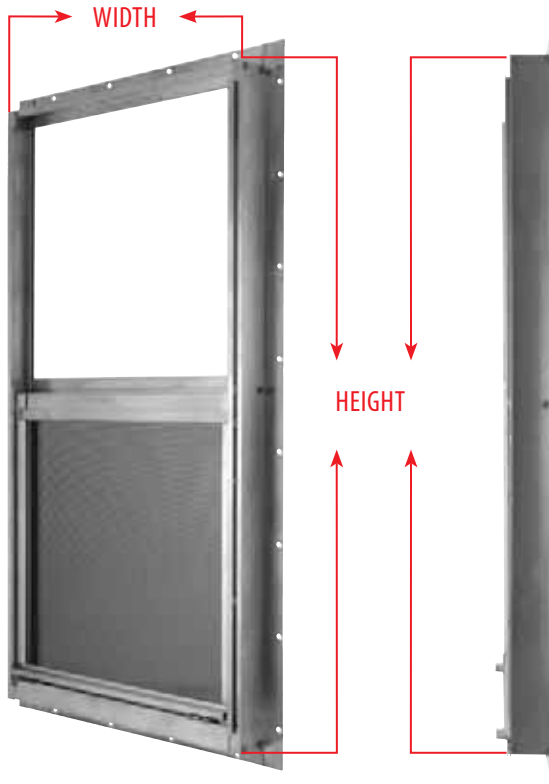

18000/19000 Series—example				
SKU	DESCRIPTION	CALL SIZE WIDTH x HEIGHT	ACTUAL BUILD SIZE WIDTH x HEIGHT	ROUGH OPENING WIDTH x HEIGHT
68K61421	WINDOW-ALUM VS 14" x 21" MILL	14" x 21"	14" x 21"	14 ¼" x 21 ¼"
68K61427	WINDOW-ALUM VS 14" x 27" MILL	14" x 27"	14" x 27"	14 ¼" x 27 ¼"
68K61440	WINDOW-ALUM VS 14" x 40" MILL	14" x 40"	14" x 40"	14 ¼" x 40 ¼"
68K61454	WINDOW-ALUM VS 14" x 54" MILL	14" x 54"	14" x 53 ⅞"	14 ¼" x 54 ⅞"
68K61827	WINDOW-ALUM VS 18" x 27" MILL	18" x 27"	18" x 27"	18 ¼" x 27 ¼"
68K62227	WINDOW-ALUM VS 22" x 27" MILL	22" x 27"	22" x 27"	22 ¼" x 27 ¼"
68K62427	WINDOW-ALUM VS 24" x 27" MILL	24" x 27"	24" x 27"	24 ¼" x 27 ¼"
9750 Series—example				
SKU	DESCRIPTION	CALL SIZE WIDTH x HEIGHT	ACTUAL BUILD SIZE WIDTH x HEIGHT	ROUGH OPENING WIDTH x HEIGHT
68K11427	WINDOW-VINYL 14" x 27"	14" x 27"	14" x 27"	14 ¼" x 27 ¼"
68K11440	WINDOW-VINYL 14" x 40"	14" x 40"	14" x 40"	14 ¼" x 40 ¼"
68K12440	WINDOW-VINYL 24" x 40"	24" x 40"	24" x 40"	24 ¼" x 40 ¼"
68K13027	WINDOW-VINYL 30" x 27"	30" x 27"	30" x 27"	30 ¼" x 27 ¼"
68K13040	WINDOW-VINYL 30" x 40"	30" x 40"	30" x 40"	30 ¼" x 40 ¼"
<b>CONTACT YOUR SALES REPRESENTATIVE FOR HELP AND A COMPLETE LIST OF SIZES</b>				



## **Series 18000**

# **Aluminum Vertical Slider Main Window**

### **FEATURES**

- Large flush mounting flange for easy installation
- Interlocking meeting rails provide additional security and structural performance
- Quality pile weather-stripping at sash head and jambs for maximum weather resistance
- Soft vinyl bulb gasket for additional weather seal
- Sloped sill and large built-in weep holes for superior drainage
- Jambs notched for multiple opening positions with spring-loaded latches
- Nylon glides enable easy window sash operation
- Screen included

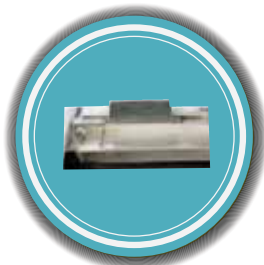

*Spring-Loaded Latches*



*Large Flush Mount  
For Easy Installation*



*Interlocking Meeting Rails  
Provide Additional Security  
And Structural Performance*

**NEW SIZES ADDED REGULARLY – CONTACT YOUR SALES REPRESENTATIVE**

Product Availability, Prices and Specifications Subject to Change without Notice

## DOORS & WINDOWS

<b>SERIES 18000 WINDOW ALUMINUM VERTICAL SLIDER MAIN WINDOW</b>			
SIZE W x H	DESCRIPTION	COLOR	PART NUMBER
14" x 21"	WINDOW-ALUM-V SLIDE	MILL	68K61421
14" x 21"	WINDOW-ALUM-V SLIDE	OBSCURE (WINDOW)	68K61421OBS
14" x 27"	WINDOW-ALUM-V SLIDE	MILL	68K61427
14" x 27"	WINDOW-ALUM-V SLIDE	OBSCURE (WINDOW)	68K61427OBS
14" x 40"	WINDOW-ALUM-V SLIDE	MILL	68K61440
14" x 40"	WINDOW-ALUM-V SLIDE	OBSCURE (WINDOW)	68K61440OBS
14" x 54"	WINDOW-ALUM-V SLIDE	MILL	68K61454
18" x 27"	WINDOW-ALUM-V SLIDE	MILL	68K61827
22" x 27"	WINDOW-ALUM-V SLIDE	MILL	68K62227
24" x 27"	WINDOW-ALUM-V SLIDE	MILL	68K62427
24" x 27"	WINDOW-ALUM-V SLIDE	WHITE LAP	68K62427WL
24" x 40"	WINDOW-ALUM-V SLIDE	MILL	68K62440
30" x 21"	WINDOW-ALUM-V SLIDE	MILL	68K63021
30" x 27"	WINDOW-ALUM-V SLIDE	MILL	68K63027
30" x 27"	WINDOW-ALUM-V SLIDE	WHITE LAP	68K63027WL
30" x 30"	WINDOW-ALUM-V SLIDE	MILL	68K63030
30" x 36"	WINDOW-ALUM-V SLIDE	MILL	68K63036
30" x 40"	WINDOW-ALUM-V SLIDE	MILL	68K63040
30" x 40"	WINDOW-ALUM-V SLIDE	WHITE	68K63040W
30" x 40"	WINDOW-ALUM-V SLIDE	WHITE LAP	68K63040WL
30" x 52"	WINDOW-ALUM-V SLIDE	MILL	68K63052
30" x 53"	WINDOW-ALUM-V SLIDE	MILL	68K63053
30" x 54"	WINDOW-ALUM-V SLIDE	MILL	68K63054
30" x 54"	WINDOW-ALUM-V SLIDE	WHITE	68K63054W
30" x 54"	WINDOW-ALUM-V SLIDE	WHITE LAP	68K63054WL
30" x 58"	WINDOW-ALUM-V SLIDE	MILL	68K63058
30" x 60"	WINDOW-ALUM-V SLIDE	MILL	68K63060
30" x 60"	WINDOW-ALUM-V SLIDE	WHITE LAP WITH GRIDS	68K63060WLG
36" x 27"	WINDOW-ALUM-V SLIDE	MILL	68K63627
36" x 36"	WINDOW-ALUM-V SLIDE	MILL	68K63636
36" x 36"	WINDOW-ALUM-V SLIDE	WHITE	68K63636W
36" x 40"	WINDOW-ALUM-V SLIDE	MILL	68K63640
36" x 40"	WINDOW-ALUM-V SLIDE	WHITE	68K63640W
36" x 54"	WINDOW-ALUM-V SLIDE	MILL	68K63654
40" x 27"	WINDOW-ALUM-V SLIDE	MILL	68K64027
40" x 36"	WINDOW-ALUM-V SLIDE	MILL	68K64036
40" x 40"	WINDOW-ALUM-V SLIDE	MILL	68K64040
40" x 54"	WINDOW-ALUM-V SLIDE	MILL	68K64054
46" x 27"	WINDOW-ALUM-V SLIDE	MILL	68K64627
46" x 36"	WINDOW-ALUM-V SLIDE	MILL	68K64636
46" x 40"	WINDOW-ALUM-V SLIDE	MILL	68K64640
46" x 40"	WINDOW-ALUM-V SLIDE	WHITE	68K64640W
46" x 53"	WINDOW-ALUM-V SLIDE	MILL	68K64653
46" x 54"	WINDOW-ALUM-V SLIDE	MILL	68K64654

<b>SERIES 18000 HORIZONTAL SLIDER ALUMINUM MAIN WINDOW</b>			
SIZE W x H	DESCRIPTION	COLOR	PART NUMBER
30" X 14"	WINDOW-HZ SLIDE	MILL	68K33014
30" X 27"	WINDOW-HZ SLIDE	MILL	68K33027
30" X 40"	WINDOW-HZ SLIDE	MILL	68K33040
46" X 27"	WINDOW-HZ SLIDE	MILL	68K34627
46" X 40"	WINDOW-HZ SLIDE	MILL	68K34640



## Series 5700 Self Storing Storm Window

### FEATURES

- Large flush mounting flange for easy installation
- Removable upper and lower sash are marine glazed for superior weather resistance
- Full interlock at meeting rail to provide window security and strength
- Latch strike allows varied opening heights for desired amount of ventilation
- Quality pile weather-strip throughout for maximum weather resistance
- Two spring loaded thumb latches for operation of removable lower sash
- Soft durable leaf vinyl provides tight weather seal between sash and sill
- Pile weather-strip along length of jamb to complete weather-strip package

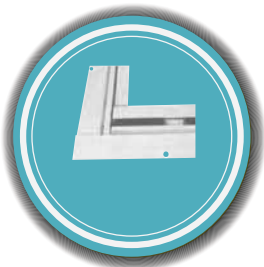

Two Spring Loaded Thumb Latches For Operation Of Removable Lower Sash

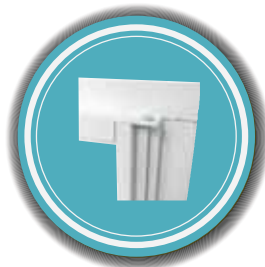

Marine Glazed Fixed Panel And Sash For Superior Weatherproofing

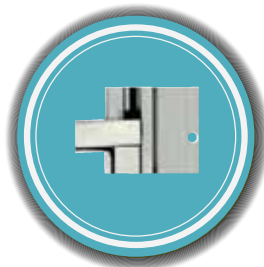

Full Interlock To Provide Window Security And Weatherproofing



Large Flush Mount For Easy Installation

NEW SIZES ADDED REGULARLY – CONTACT YOUR SALES REPRESENTATIVE

## DOORS & WINDOWS

### SERIES 5700 VERTICAL SLIDE SELF STORING STORM WINDOW

SIZE W x H	DESCRIPTION	COLOR	PART NUMBER
14" x 21"	WINDOW-STORM V SLIDE	WHITE	68K51421
14" x 27"	WINDOW-STORM V SLIDE	WHITE	68K51427
14" x 40"	WINDOW-STORM V SLIDE	WHITE	68K51440
14" x 54"	WINDOW-STORM V SLIDE	WHITE	68K51454
18" x 27"	WINDOW-STORM V SLIDE	WHITE	68K51827
24" x 27"	WINDOW-STORM V SLIDE	WHITE	68K52427
24" x 40"	WINDOW-STORM V SLIDE	WHITE	68K52440
30" x 21"	WINDOW-STORM V SLIDE	WHITE	68K53021
30" x 27"	WINDOW-STORM V SLIDE	WHITE	68K53027
30" x 30"	WINDOW-STORM V SLIDE	WHITE	68K53030
30" x 36"	WINDOW-STORM V SLIDE	WHITE	68K53036
30" x 40"	WINDOW-STORM V SLIDE	WHITE	68K53040
30" x 52"	WINDOW-STORM V SLIDE	WHITE	68K53052
30" x 53"	WINDOW-STORM V SLIDE	WHITE	68K53053
30" x 54"	WINDOW-STORM V SLIDE	WHITE	68K53054
30" x 58"	WINDOW-STORM V SLIDE	WHITE	68K53058
32" X 54"	WINDOW-STORM V SLIDE	WHITE	68K53254
36" x 36"	WINDOW-STORM V SLIDE	WHITE	68K53636
36" x 40"	WINDOW-STORM V SLIDE	WHITE	68K53640
36" x 54"	WINDOW-STORM V SLIDE	WHITE	68K53654
40" x 27"	WINDOW-STORM V SLIDE	WHITE	68K54027
40" x 36"	WINDOW-STORM V SLIDE	WHITE	68K54036
40" x 54"	WINDOW-STORM V SLIDE	WHITE	68K54054
46" x 27"	WINDOW-STORM V SLIDE	WHITE	68K54627
46" x 40"	WINDOW-STORM V SLIDE	WHITE	68K54640
46" X 53"	WINDOW-STORM V SLID	WHITE	68K54653
46" x 54"	WINDOW-STORM V SLIDE	WHITE	68K54654

### SERIES 5700 HORIZONTAL SLIDE SELF STORING STORM WINDOW

SIZE W X H	DESCRIPTION	COLOR	PART NUMBER
46" x 40"	WINDOW-STORM-HZ SLIDE	WHITE	68KH4640





**Series 9750  
Vinyl Double Pane  
Single Hung  
Window**

**Features**

- Vinyl construction provides high thermal performance
- Frame and sash corners are welded for added strength and water tight corners
- Deep pocket sill for added window strength and weather resistance
- Window sash can be removed for easy cleaning on any level of the home
- Reinforcement bars in the meeting rails provide added strength
- Positive integral lock at the meeting rail for increased home security and weather resistance
- Dual weather seal to reduce drafts and enhance energy efficiency
- Nominal ¾" insulating glass provides superior thermal performance
- Optional grids are sandwiched between panes



Two Spring Loaded Thumb Latches For Operation Of Removable Lower Sash



Marine Glazed Fixed Panel And Sash For Superior Weatherproofing



Frame And Sash Corners Are Welded For Added Strength And Water Tight Corners



Window Sash Can Be Removed For Easy Cleaning On Any Level Of The Home

NEW SIZES ADDED REGULARLY – CONTACT YOUR SALES REPRESENTATIVE

## DOORS & WINDOWS

### SERIES 9750 VINYL SINGLE HUNG WINDOW

SIZE W x H	DESCRIPTION	COLOR	PART NUMBER
14" x 27"	WINDOW-VINYL	WHITE	68K21427
14" x 27"	WINDOW-VINYL	WHITE W/GRIDS	68K21427G
14" x 27"	WINDOW-VINYL	WHITE W/ OBSCURE WINDOW	68K21427OBS
14" x 39"	WINDOW-VINYL	WHITE	68K21439
14" x 40"	WINDOW-VINYL	WHITE	68K21440
14" x 40"	WINDOW-VINYL	WHITE W/GRIDS	68K21440G
14" x 53"	WINDOW-VINYL	WHITE	68K21453
24" x 40"	WINDOW-VINYL	WHITE	68K22440
30" x 27"	WINDOW-VINYL	WHITE	68K23027
30" x 27"	WINDOW-VINYL	WHITE W/GRIDS	68K23027G
30" x 39"	WINDOW-VINYL	WHITE	68K23039
30" x 40"	WINDOW-VINYL	WHITE	68K23040
30" x 40"	WINDOW-VINYL	WHITE W/GRIDS	68K23040G
30" x 53"	WINDOW-VINYL	WHITE	68K23053
30" x 53"	WINDOW-VINYL	WHITE W/GRIDS	68K23053G
30" x 54"	WINDOW-VINYL	WHITE	68K23054
30" x 54"	WINDOW-VINYL	WHITE W/GRIDS	68K23054G
30" x 58"	WINDOW-VINYL	WHITE	68K23058
30" x 60"	WINDOW-VINYL	WHITE	68K23060
30" x 68"	WINDOW-VINYL	WHITE	68K23068
36" x 27"	WINDOW-VINYL	WHITE	68K23627
36" x 40"	WINDOW-VINYL	WHITE	68K23640
36" x 53"	WINDOW-VINYL	WHITE	68K23653
36" x 54"	WINDOW-VINYL	WHITE	68K23654
36" x 54"	WINDOW-VINYL	WHITE W/GRIDS	68K23654G
40" x 54"	WINDOW-VINYL	WHITE	68K24054
46" x 27"	WINDOW-VINYL	WHITE	68K24627
46" x 39"	WINDOW-VINYL	WHITE	68K24639
46" x 40"	WINDOW-VINYL	WHITE	68K24640
46" x 40"	WINDOW-VINYL	WHITE W/GRIDS	68K24640G
46" x 53"	WINDOW-VINYL	WHITE	68K24653
46" x 54"	WINDOW-VINYL	WHITE	68K24654
46" x 54"	WINDOW-VINYL	WHITE W/GRIDS	68K24654G

**SERIES 9750  
VINYL SINGLE HUNG  
ENERGY STAR WINDOW**



CALL FOR REGIONAL PRICING AND AVAILABILITY

Product Availability, Prices and Specifications Subject to Change without Notice



## Series 1600 Vinyl Rolling Glass Door

### Features

- Heat fusion welded frame and moving panel provides superior structural strength and prevents potential leakage at the corners
- Staggered internal weep system allows minimum dust infiltration
- Snap-in weep covers are standard
- Exterior glazing design improves resistance to wind and water
- ¾" sealed insulating glass (tempered) with "intercept" spacer provides optimum thermal performance.
- High quality fin seal weatherstrip around moving panel perimeter insures a positive seal against the wind and water
- Color coordinated attractive mortise type keyed lock mounted on steel reinforced lock jamb for strength sturdiness that provides added security
- Anti-lift design feature requires moving panel to be in fully open position before panel can be removed for added security.



Heavy Duty Steel Tandem Rollers Insures Trouble Free Operation

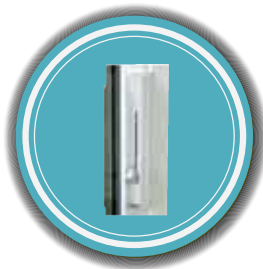

Color Coordinated Attractive Lock



Inside Lever Of Color Coordinated Attractive Clam Type Keyed Lock Mounted On Hollow Lock Jamb



Heavy Duty Welded Corners For Strength And Durability





## Series 7500 Rolling Glass Door

### Features

- Available in a variety of tempered glazing options in single or insulating glass
- 5/8" sealed insulating glass (tempered) with optional Low-E provides optimum thermal performance
- Heavy duty fin seal weatherstrip to reduce air, water, dust and noise infiltration
- Anti-rattle snigger bumper feature in lock jamb keeps the moving panel snug and tight
- Color coordinated attractive clam type keyed lock mounted on hollow lock jamb for strength and sturdiness that provides added security
- Full length lip on lock jamb acts as lock strike, not requiring adjustments after the door is properly installed
- Heavy duty rolling screen door with adjustable rollers
- Sill is replaceable



Heavy Duty Steel Tandem Rollers Insures Trouble Free Operation



Color Coordinated Attractive Clam Type Keyed Lock Mounted On Hollow Lock Jamb



Heavy Duty Fin Seal Weatherstrip To Reduce Air, Water, Dust And Noise Infiltration



Heavy Duty Welded Corners For Strength And Durability





**REPLACEMENT WINDOWS  
AND SCREEN UNITS FOR  
KINRO DOORS AND WINDOWS**

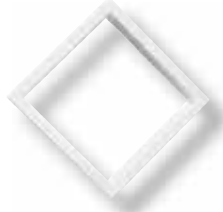

DIAMOND



SUNBURST



VERTICAL SLIDER - MILL FINISH



COTTAGE

**WINDOW UNITS FOR 5140/5210 SERIES**

- 69350002 DOOR LITE-5140/5210-10" x 10" DIAMOND
- 69350003 DOOR LITE-5140/5210-20" x 36"-9 LITE
- 69350004 DOOR LITE-5140/5210-14" x 27" VERTICAL SLIDER

**WINDOW UNITS FOR 7660 SERIES**

- 69350022 DOOR LITE-7660-COTTAGE
- 69350023 DOOR LITE-7660-SUNBURST

**SCREEN REPLACEMENT UNITS FOR 1600 VINYL SERIES ROLLING GLASS DOORS**

- 69K7167276 SCREEN REPLACEMENT-72" x 76"-1600 SERIES
- 69K7167280 SCREEN REPLACEMENT-72" x 80"-1600 SERIES

**SCREEN REPLACEMENT UNITS FOR 7500 SERIES ROLLING GLASS DOORS**

- 69K7756072 SCREEN REPLACEMENT-60" x 72"-7500 SERIES
- 69K7756076 SCREEN REPLACEMENT-60" x 76"-7500 SERIES

**SCREEN REPLACEMENT UNITS FOR 18000 SEFRIES VERTICAL SLIDER WINDOWS**

- 68K71427 SCREEN REPLACEMENT-14" x 27" MILL-18000 SERIES
- 68K73027 SCREEN REPLACEMENT-30" x 27" MILL-18000 SERIES
- 68K73040 SCREEN REPLACEMENT-30" x 40" MILL-18000 SERIES
- 68K73053 SCREEN REPLACEMENT-30" x 53"/54" MILL-18000 SERIES
- 68K73654 SCREEN REPLACEMENT-36" x 54"/54" MILL-18000 SERIES
- 68K74654 SCREEN REPLACEMENT-46" x 54" MILL-18000 SERIES

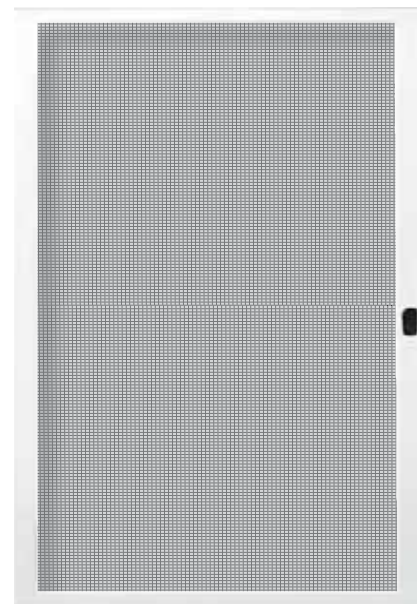

ROLLING GLASS DOOR REPLACEMENT SCREEN UNIT

**PATIO DOOR HANDLE KIT**  
1600 SERIES



691618 PATIO DOOR HANDLE KIT  
FOR 1600 SERIES

**PATIO DOOR HANDLE KIT**  
7500 SERIES



697508 PATIO DOOR HANDLE KIT  
FOR 7500 SERIES

**PATIO SCREEN DOOR  
HANDLE KIT**



691630 PATIO DOOR HANDLE KIT

**WINDOW LATCH REPAIR KIT**  
9750 SERIES WINDOWS



67019750 WINDOW LATCH REPAIR KIT  
FOR 9750 SERIES WINDOWS

**PATIO DOOR ROLLER**  
1600 SERIES



691608 PATIO DOOR ROLLER  
FOR 1600 SERIES

**PATIO DOOR ROLLER**  
7500 SERIES



697506 PATIO DOOR ROLLER  
FOR 7500 SERIES

**PAINT-7660 KINRO DOOR**  
ALPINE WHITE



69350001 PAINT-KINRO DOOR-WHITE  
FOR 7600 SERIES

**KINRO STORM DOOR CLOSER**  
PNEUMATIC



69350024 BLACK

**WINDOW LATCH REPAIR KIT**  
18000 SERIES WINDOWS



670118000 WINDOW LATCH REPAIR KIT  
FOR 18000 SERIES WINDOWS





## *How To Effectively Measure Elixir Storm Doors, Cores and Outswing Exterior Doors*

<b>REGULAR OUTSWING DOORS (200, 300 OR 400 SERIES)</b>				
<b>Call Size</b>	<b>Actual Pan Width Measurement</b>	<b>Actual Pan Length Measurement</b>	<b>Actual Width Measurement</b>	<b>Actual Lip Length Measurement</b>
32" x 72"	30 ¾"	70 ¾"	32"	72"
32" x 74"	30 ¾"	72 ¾"	32"	74"
32" x 76"	30 ¾"	74 ¾"	32"	76"
32" x 78"	30 ¾"	76 ¾"	32"	78"
32" x 80"	30 ¾"	78 ¾"	32"	80"
34" x 72"	32 ¾"	70 ¾"	34"	72"
34" x 74"	32 ¾"	72 ¾"	34"	74"
34" x 76"	32 ¾"	74 ¾"	34"	76"
34" x 78"	32 ¾"	76 ¾"	34"	78"
34" x 80"	32 ¾"	78 ¾"	34"	80"
36" x 72"	34 ¾"	70 ¾"	36"	72"
36" x 74"	34 ¾"	72 ¾"	36"	74"
36" x 76"	34 ¾"	74 ¾"	36"	76"
36" x 78"	34 ¾"	76 ¾"	36"	78"
36" x 80"	34 ¾"	78 ¾"	36"	80"

## DOORS & WINDOWS

<b>REGULAR OUTSWING WIDE DOORS (200 SERIES)</b>				
<b>Call Size</b>	<b>Actual Pan Width Measurement</b>	<b>Actual Pan Length Measurement</b>	<b>Actual Width Measurement</b>	<b>Actual Lip Length Measurement</b>
42" x 72"	40 ¾"	70 ¾"	42"	72"
42" x 76"	40 ¾"	74 ¾"	42"	76"
42" x 78"	40 ¾"	76 ¾"	42"	78"
42" x 80"	40 ¾"	78 ¾"	42"	80"
46" x 72"	45 ¼"	70 ¾"	46 ½"	72"
46" x 75"	45 ¼"	73 ¾"	46 ½"	75"
46" x 76"	45 ¼"	74 ¾"	46 ½"	76"
46" x 78"	45 ¼"	76 ¾"	46 ½"	78"
48" x 72"	46 ¾"	70 ¾"	48"	72"
48" x 76"	46 ¾"	74 ¾"	48"	76"
48" x 78"	46 ¾"	76 ¾"	48"	78"
48" x 80"	46 ¾"	78 ¾"	48"	80"

<b>REGULAR OUTSWING DOUBLE DOORS (200, 400 SERIES)</b>				
<b>Call Size</b>	<b>Actual Pan Width Measurement</b>	<b>Actual Pan Length Measurement</b>	<b>Actual Width Measurement</b>	<b>Actual Lip Length Measurement</b>
61" x 72"	59 ¾"	70 ¾"	61"	72"
61" x 75"	59 ¾"	73 ¾"	61"	75"
70 ½" x 75"	69 ¼"	73 ¾"	70 ½"	75"
72" x 72"	70 ¾"	70 ¾"	72"	72"
72" x 76"	70 ¾"	74 ¾"	72"	76"
72" x 80"	70 ¾"	78 ¾"	72"	80"
73" x 72"	71 ¾"	70 ¾"	73"	72"
73" x 76"	71 ¾"	74 ¾"	73"	76"
73" x 80"	71 ¾"	78 ¾"	73"	80"



HOUSE TYPE INSWING DOORS WITH STORMS (6000, 8000 AND 9000 SERIES)						
Call Size	Actual Pan Width Measurement	Actual Pan Length Measurement	Actual Width Measurement	Actual Lip Length Measurement	Actual Storm Core Width	Actual Storm Core Length
32" x 72"	29 7/8"	69 1/2"	31 1/8"	70 3/4"	30 1/16"	71"
32" x 74"	29 7/8"	71 1/2"	31 1/8"	72 3/4"	30 1/16"	73"
32" x 76"	29 7/8"	73 1/2"	31 1/8"	74 3/4"	30 1/16"	75"
32" x 78"	29 7/8"	75 1/2"	31 1/8"	76 3/4"	30 1/16"	77"
32" x 80"	29 7/8"	77 1/2"	31 1/8"	78 3/4"	30 1/16"	79"
34" x 72"	31 7/8"	69 1/2"	33 1/8"	70 3/4"	32 1/16"	71"
34" x 74"	31 7/8"	71 1/2"	33 1/8"	72 3/4"	32 1/16"	73"
34" x 76"	31 7/8"	73 1/2"	33 1/8"	74 3/4"	32 1/16"	75"
34" x 78"	31 7/8"	75 1/2"	33 1/8"	76 3/4"	32 1/16"	77"
34" x 80"	31 7/8"	77 1/2"	33 1/8"	78 3/4"	32 1/16"	79"
36" x 76"	33 7/8"	73 1/2"	35 1/8"	74 3/4"	34 1/16"	75"
36" x 78"	33 7/8"	75 1/2"	35 1/8"	76 3/4"	34 1/16"	77"
36" x 80"	33 7/8"	77 1/2"	35 1/8"	78 3/4"	34 1/16"	79"
38" x 76"	35 1/2"	73 3/4"	36 3/4"	74 3/4"	35 5/8"	75"
38" x 78"	35 1/2"	75 3/4"	36 3/4"	76 3/4"	35 5/8"	77"
38" x 80"	35 1/2"	77 3/4"	36 3/4"	78 3/4"	35 5/8"	79"
38" x 82"	35 1/2"	79 3/4"	36 3/4"	80 1/2"	35 5/8"	80"

STR DOORS WITH STORMS (1-3/4" 7000 SERIES)				
Call Size	Actual STR Core Width Measurement	Actual STR Core Length Measurement	Actual Storm Core Width	Actual Storm Core Length
34" x 76"	32 1/8"	73 1/2"	32 1/16"	75"
34" x 78"	32 1/8"	75 1/2"	32 1/16"	77"
34" x 80"	32 1/8"	77 1/2"	32 1/16"	79"
34" x 82"	32 1/8"	79 1/4"	32 1/16"	81"
38" x 76"	35 5/8"	73 1/2"	35 5/8"	75"
38" x 80"	35 5/8"	77 1/2"	35 5/8"	79"
38" x 82"	35 5/8"	79 1/4"	35 5/8"	81"

# DOORS & WINDOWS

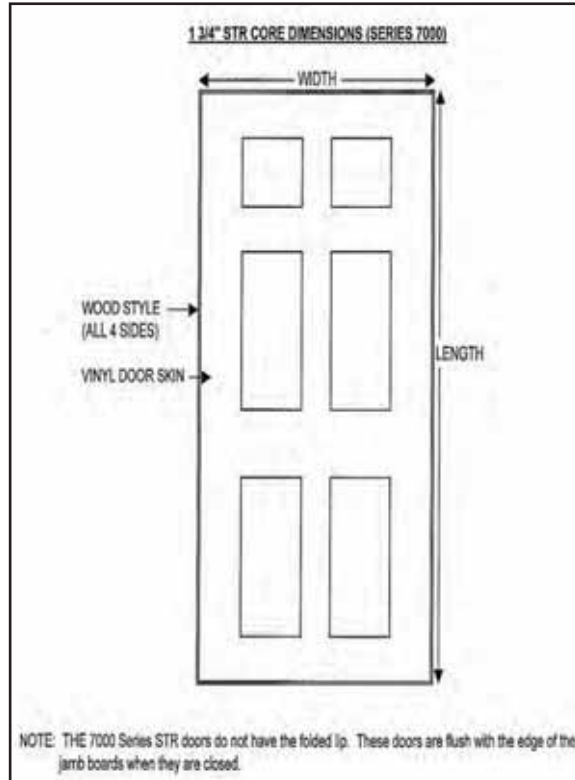
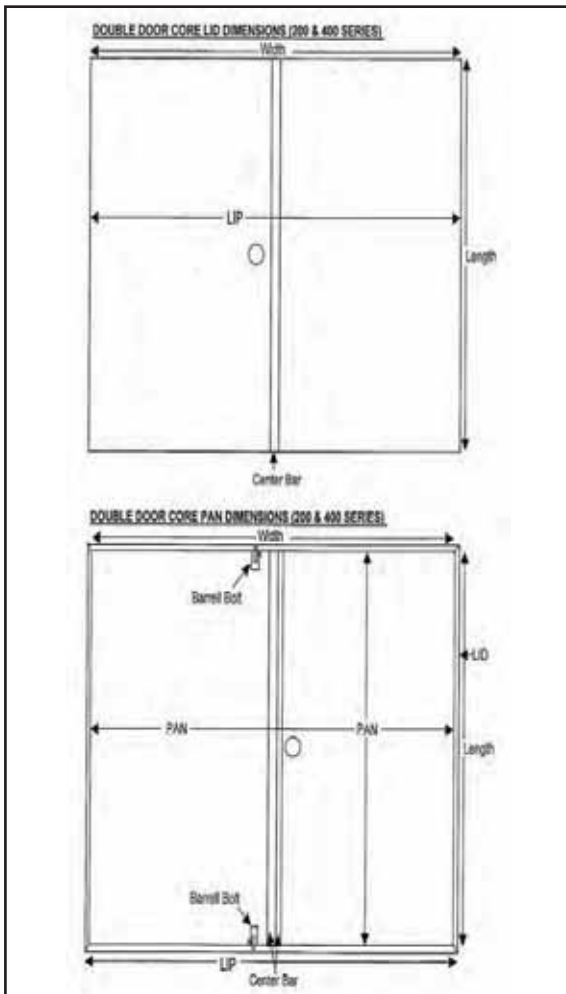
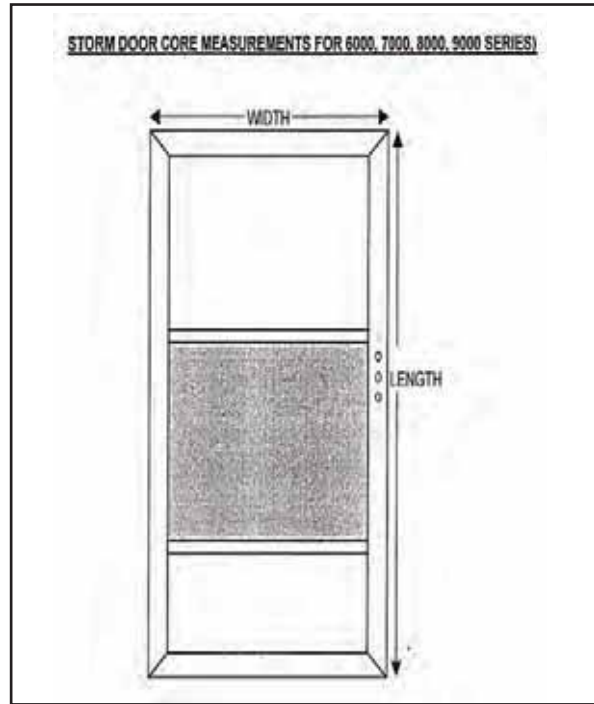
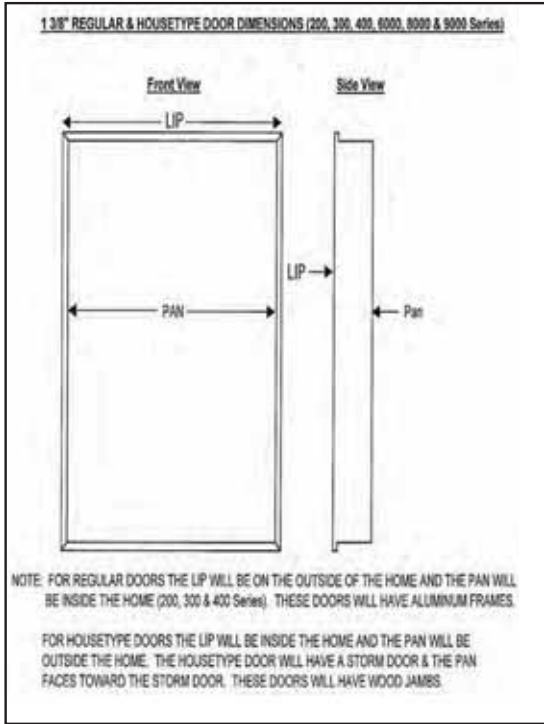



## Series 200 Outswing Door

### Features

- Time proven construction (30 years)
- Painted, galvanized steel skinned
- Heavy duty aluminum frame
- Energy efficient polyurethane foam core
- Adjustable strike plates
- Dead bolt prepped
- Double weather strip seal
- Large variety of sizes and window options



Touch up paint for  
Elixir 200 and 6000 series doors  
Part number 69E5502

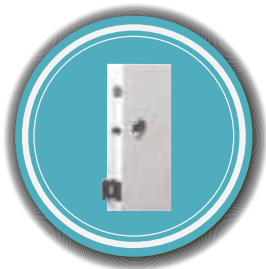

Dead Bolt Prepped.



Optional Slider Window



Optional Cottage Window

NEW SIZES ADDED REGULARLY – CONTACT YOUR SALES REPRESENTATIVE

Product Availability, Prices and Specifications Subject to Change without Notice

## DOORS & WINDOWS

SERIES 200 OUTSWING DOOR				
Size W x H	DOOR DESCRIPTION	OPENING DIRECTION	WINDOW TYPE	PART NUMBER
30" x 72"	OUTSWING SINGLE DOOR	LEFT HAND	18" x 20"	69E43072L3NNO
		RIGHT HAND	BLANK	69E43072R0NNO
32" x 72"	OUTSWING SINGLE DOOR	LEFT HAND	BLANK	69E43272L0NNO
			10" x 10"	69E43272L1NNO
			18" x 20"	69E43272L3NNO
		RIGHT HAND	BLANK	69E43272R0NNO
			10" x 10"	69E43272R1NNO
			18" x 20"	69E43272R3NNO
32" x 74"	OUTSWING SINGLE DOOR	LEFT HAND	BLANK	69E43274L0NNO
			18" x 20"	69E43274L3NNO
		RIGHT HAND	BLANK	69E43274R0NNO
			18" x 20"	69E43274R3NNO
32" x 76"	OUTSWING SINGLE DOOR	LEFT HAND	BLANK	69E43276L0NNO
			10" x 10"	69E43276L1NNO
			18" x 20"	69E43276L3NNO
			COTTAGE	69E43276L4NNO
		RIGHT HAND	BLANK	69E43276R0NNO
			10" x 10"	69E43276R1NNO
			18" x 20"	69E43276R3NNO
			COTTAGE	69E43276R4NNO
32" x 78"	OUTSWING SINGLE DOOR	LEFT HAND	10" x 10"	69E43278L1NNO
			18" x 20"	69E43278L3NNO
		RIGHT HAND	10" x 10"	69E43278R1NNO
			18" x 20"	69E43278R3NNO
34" x 76"	OUTSWING SINGLE DOOR	LEFT HAND	BLANK	69E43476L0NNO
			10" x 10"	69E43476L1NNO
			18" x 20"	69E43476L3NNO
			COTTAGE	69E43476L4NNO
		RIGHT HAND	BLANK	69E43476R0NNO
			10" x 10"	69E43476R1NNO
			18" x 20"	69E43476R3NNO
			COTTAGE	69E43476R4NNO
34" x 78"	OUTSWING SINGLE DOOR	LEFT HAND	10" x 10"	69E43478L1NNO
		RIGHT HAND	10" x 10"	69E43478R1NNO
34" x 80"	OUTSWING SINGLE DOOR	LEFT HAND	10" x 10"	69E43480L1NNO
		RIGHT HAND	10" x 10"	69E43480R1NNO
36" x 76"	OUTSWING SINGLE DOOR	LEFT HAND	BLANK	69E43676L0NNO
			10" x 10"	69E43676L1NNO
		RIGHT HAND	10" x 10"	69E43676R1NNO
36" x 80"	OUTSWING SINGLE DOOR	LEFT HAND	BLANK	69E43680L0NNO
			10" x 10"	69E43680L1NNO
			18" x 20"	69E43680L3NNO
			18" x 20"	69E43680L3WNO
		RIGHT HAND	BLANK	69E43680R0NNO
			10" x 10"	69E43680R1NNO
			18" x 20"	69E43680R3NNO
			18" x 20"	69E43680R3WNO



## Series 6000 Combination Door

### Features

- Time proven construction (30 years)
- Painted, galvanized steel skinned
- Adjustable stop wood jamb
- Energy efficient polyurethane foam core
- Adjustable strike plates
- Dead bolt prepped
- Double weather strip seal
- Heavy duty storm door (1 1/8" thick)
- Large variety of sizes and window options



Touch up paint for  
Elixir 200 and 6000 series doors  
Part number 69E5502



Storm Window Slider Lock

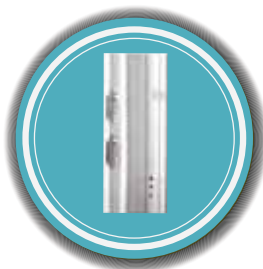

Adjustable Strike Plates



Dead Bolt Prepped



Heavy Duty Aluminum Frame

NEW SIZES ADDED REGULARLY – CONTACT YOUR SALES REPRESENTATIVE

## DOORS & WINDOWS

<b>SERIES 6000 COMBINATION DOOR</b>							
Size W x H	DOOR DESCRIPTION	DOOR DIRECTION	WINDOW TYPE	STORM COLOR	STORM TYPE	JAMB SIZE	PART NUMBER
32" x 76"	COMBO DOOR	LEFT HAND	10" x 10"	MILL	CONVENTIONAL	4"	69E73276L1MC0
			10" x 10"	WHITE	CONVENTIONAL	4"	69E73276L1WC0
		RIGHT HAND	10" x 10"	MILL	CONVENTIONAL	4"	69E73276R1MC0
			10" x 10"	WHITE	CONVENTIONAL	4"	69E73276R1WC0
34" x 76"	COMBO DOOR	LEFT HAND	10" x 10"	MILL	CONVENTIONAL	4"	69E73476L1MC0
			10" x 10"	WHITE	CONVENTIONAL	4"	69E73476L1WC0
			10" x 10"	WHITE	CONVENTIONAL	6 ½"	69E73476L1WC2
			COTTAGE	WHITE	CONVENTIONAL	6 ½"	69E73476L4WC2
		RIGHT HAND	FAN	WHITE	CONVENTIONAL	4"	69E73476L5WC0
			10" x 10"	MILL	CONVENTIONAL	4"	69E73476R1MC0
			10" x 10"	WHITE	CONVENTIONAL	4"	69E73476R1WC0
			10" x 10"	WHITE	CONVENTIONAL	6 ½"	69E73476R1WC2
FAN	WHITE	CONVENTIONAL	4"	69E73476R5WC0			
34" x 78"	COMBO DOOR	LEFT HAND	10" x 10"	MILL	CONVENTIONAL	4"	69E73478L1MC0
			10" x 10"	WHITE	CONVENTIONAL	4"	69E73478L1WC0
			COTTAGE	WHITE	CONVENTIONAL	6 ½"	69E73478L4WC2
		RIGHT HAND	10" x 10"	MILL	CONVENTIONAL	4"	69E73478R1MC0
			10" x 10"	WHITE	CONVENTIONAL	4"	69E73478R1WC0
			COTTAGE	WHITE	CONVENTIONAL	6 ½"	69E73478R4WC2
34" x 80"	COMBO DOOR	LEFT HAND	10" x 10"	MILL	CONVENTIONAL	4"	69E73480L1MC0
			10" x 10"	WHITE	CONVENTIONAL	4"	69E73480L1WC0
		RIGHT HAND	10" x 10"	MILL	CONVENTIONAL	4"	69E73480R1MC0
			10" x 10"	WHITE	CONVENTIONAL	4"	69E73480R1WC0
36" x 76"	COMBO DOOR	LEFT HAND	10" x 10"	WHITE	CONVENTIONAL	4"	69E73676L1WC0
		RIGHT HAND	10" x 10"	WHITE	CONVENTIONAL	4"	69E73676R1WC0
36" x 78"	COMBO DOOR	RIGHT HAND	10" x 10"	MILL	CONVENTIONAL	4"	69E73678R1MC0
36" x 80"	COMBO DOOR	LEFT HAND	10" x 10"	WHITE	CONVENTIONAL	4"	69E73680L1WC0
		RIGHT HAND	10" x 10"	WHITE	CONVENTIONAL	4"	69E73680R1WC0
38" x 76"		RIGHT HAND	10" x 10"	WHITE	CONVENTIONAL	4"	69E73876R1WC0
38" x 80"	COMBO DOOR	RIGHT HAND	10" x 10"	WHITE	CONVENTIONAL	4"	69E73880R1WC0





## Storm Doors

### Features

- Four hinges for strength and security
- Variety of sizes and styles
- Heavy duty aluminum frame
- Built in drip cap
- 1 1/8" thick frame
- 1/8" thick tempered safety glass



Storm Window Slider Lock



Built In Drip Cap

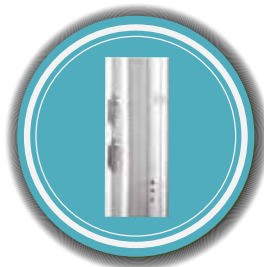

Adjustable Strike Plates



Heavy Duty Aluminum Frame

NEW SIZES ADDED REGULARLY – CONTACT YOUR SALES REPRESENTATIVE

## DOORS & WINDOWS

STORM DOORS						
Size W x H	DOOR DESCRIPTION	OPENING DIRECTION	WINDOW TYPE	STORM COLOR	STORM TYPE	PART NUMBER
32" x 76"	STORM DOOR	LEFT HAND	N/A	WHITE	CONVENTIONAL	69E83276LOWC0
		RIGHT HAND	N/A	WHITE	CONVENTIONAL	69E83276R0WC0
34" x 76"	STORM DOOR	LEFT HAND	N/A	MILL	CONVENTIONAL	69E83476L0MC0
			N/A	WHITE	CONVENTIONAL	69E83476LOWC0
			N/A	WHITE	FULL VIEW	69E83476LOWF0
		RIGHT HAND	N/A	MILL	CONVENTIONAL	69E83476R0MC0
			N/A	WHITE	CONVENTIONAL	69E83476R0WC0
			N/A	WHITE	FULL VIEW	69E83476R0WF0
			N/A	WHITE	ALL GLASS	69E83476R0WA0
34" x 78"	STORM DOOR	LEFT HAND	N/A	WHITE	CONVENTIONAL	69E83478LOWC0
		RIGHT HAND	N/A	WHITE	CONVENTIONAL	69E83478R0WC0
34" x 80"	STORM DOOR	LEFT HAND	N/A	WHITE	CONVENTIONAL	69E83480LOWC0
		RIGHT HAND	N/A	WHITE	CONVENTIONAL	69E83480R0WC0
36" x 76"	STORM DOOR	RIGHT HAND	N/A	WHITE	CONVENTIONAL	69E83676R0WC0
		LEFT HAND	N/A	WHITE	CONVENTIONAL	69E83676LOWC0
36" x 80"	STORM DOOR	LEFT HAND	N/A	WHITE	CONVENTIONAL	69E83680LOWC0
		RIGHT HAND	N/A	WHITE	CONVENTIONAL	69E83680R0WC0
38" x 76"	STORM DOOR	LEFT HAND	N/A	WHITE	CONVENTIONAL	69E83876LOWC0
		RIGHT HAND	N/A	WHITE	CONVENTIONAL	69E83876R0WC0
38" x 80"	STORM DOOR	LEFT HAND	N/A	WHITE	CONVENTIONAL	69E83880LOWC0
		RIGHT HAND	N/A	WHITE	CONVENTIONAL	69E83880R0WC0

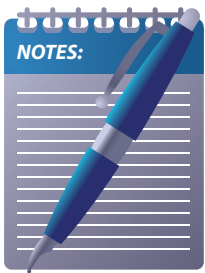

---



---



---



---



---



---



---



---



---



---



## Series 4000 Double French Door

### Features

- Attractive replacement for sliding glass patio door
- Vinyl steel skin door with a folded lip on all four sides to prevent air, water, and light infiltration
- Two 15-lite french windows with tempered insulated glass
- Heavy-duty adjustable striker plate
- Heavy aluminum extruded frames
- Polyurethane foam filled door cores provide energy efficiency

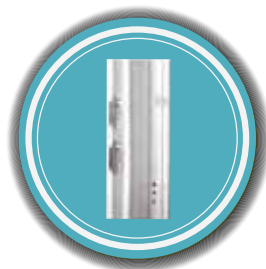

Adjustable Strike Plates



Dead Bolt Prepped

**SERIES 4000 DOUBLE FRENCH DOOR**

Size W x H	DOOR DESCRIPTION	WINDOW TYPE	STORM COLOR	STORM TYPE	JAMB SIZE	PART NUMBER
72" x 76"	DOUBLE FRENCH DOORS LH	N/A	N/A	N/A	N/A	69E97276WDFLH

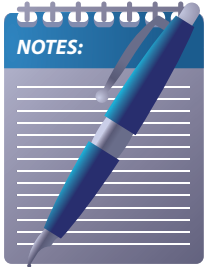

Four horizontal lines for taking notes, with a light yellow highlight on the first line.

Multiple horizontal lines for additional notes, alternating between light yellow and white highlights.



## Series 200 Utility Door

### Features

- Painted Galvanized Steel
- Double Seal
- Folded Edge with weatherstripping
- Polyurethane Foam Core
- Highly Energy Efficient
- Adjustable Striker Plates

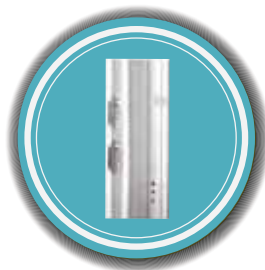

Adjustable Strike Plates



Dead Bolt Prepped

## DOORS & WINDOWS

### SERIES 200 UTILITY DOOR

Size W x H	DOOR DESCRIPTION	OPENING DIRECTION	COLOR	JAMB SIZE	PART NUMBER
48" x 80"	UTILITY	LEFT HAND	WHITE/MILL	N/A	69E5L48800NN
		RIGHT HAND	WHITE/MILL	N/A	69E5R48800NN
72" x 76"	UTILITY	LEFT HAND	WHITE/MILL	N/A	69E5L72760NN
		RIGHT HAND	WHITE/MILL	N/A	69E5R72760NN
72" x 80"	UTILITY	LEFT HAND	WHITE/MILL	N/A	69E5L72800NN
		RIGHT HAND	WHITE/MILL	N/A	69E5R72800NN



48" x 80"  
UTILITY DOOR

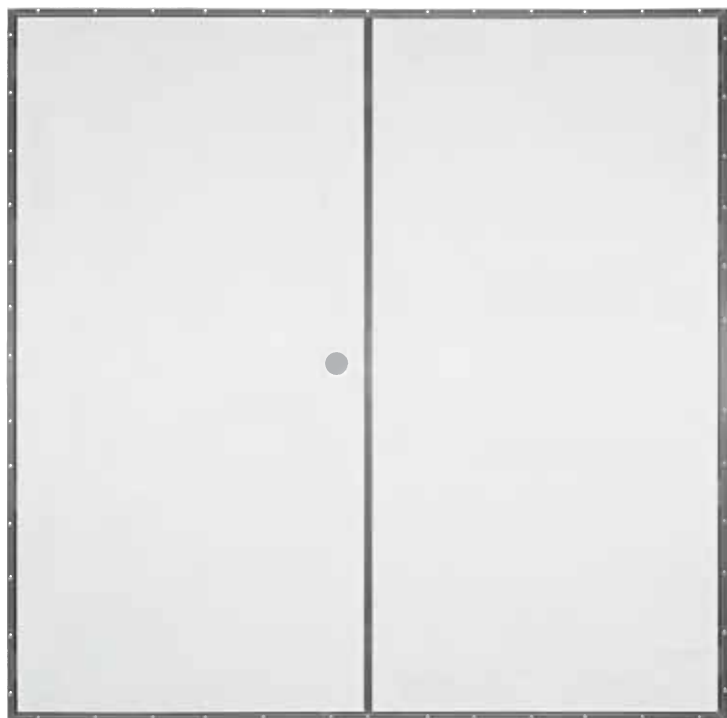

72" x 80"  
UTILITY DOOR

REPLACEMENT WINDOWS FOR ELIXIR DOORS



DIAMOND



SLIDER



COTTAGE

69351010 WINDOW-REPLACEMENT 10" x 10" DIAMOND WHITE

69351820 WINDOW-REPLACEMENT 18" x 20" SLIDER MILL

69352036 WINDOW-REPLACEMENT 20" x 36" COTTAGE WHITE

**DOORS & WINDOWS**

**ELIXIR DOOR HINGE**



69E220174 ELIXIR DOOR HINGE

**STORM DOOR CLOSER KIT**



69355301 STORM DOOR CLOSER KIT BK  
69355302 STORM DOOR CLOSER KIT WT

**DOOR DRIPCAP**



695811 DRIPCAP-MILL FINISH  
FOR 32" DOOR  
695812 DRIPCAP-MILL FINISH  
FOR 34" DOOR  
695813 DRIPCAP-MILL FINISH  
FOR 36" DOOR

**PAINT-ELIXIR DOOR**



69E5502 PAINT-ELIXIR DOOR 200/6000  
WHITE  
69E5508 PAINT-ELIXIR DOOR 7-9000  
WHITE

**THRESHOLD**



695701 THRESHOLD-32" DOOR  
695702 THRESHOLD-34" DOOR  
695703 THRESHOLD-36" DOOR



**MANUFACTURED HOUSING**

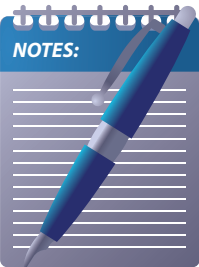

---

---

---

---

---

---

---

---

---

---



**PUSH BUTTON LATCH**



6419908 1 3/4" BLACK—50/CTN

**KNOB/WALL GUARD**



603028 WALL GUARD 3 5/16" WHITE  
603029 WALL GUARD 5" WHITE

**KNOCKER VIEWER**



69351030 KNOCKER VIEWER-BRASS

**STORM DOOR CLOSER**  
PNEUMATIC



6419678 BLACK—35/CTN

**SPRING DOOR STOP**  
BRASS



674218 3" SPRING DOOR STOP/BRASS

**CHAIN STOP-ANODIZED**

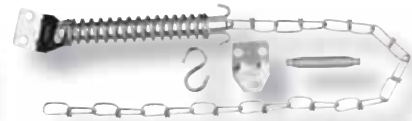

641996 10/CTN

**THRESHOLD**



695701 THRESHOLD-32" DOOR  
695702 THRESHOLD-34" DOOR  
695703 THRESHOLD-36" DOOR

**ZINC PLATED 1/4" HEX HEAD SCREWS**



65875100 #8 x 3/4" - 100/BOX  
6581100 #8 x 1" - 100/BOX  
65815100 #8 x 1 1/2" - 100/BOX  
6587520 #8 x 3/4" - 500/BOX  
658120 #8 x 1" - 500/BOX  
6581520 #8 x 1 1/2" - 500/BOX  
6582001 #8 x 2" - 500/BOX

**PAINTED HEX HEAD SCREWS**



6581101 #8 x 1" - 100/BOX  
65815101 #8 x 1 1/2" - 100/BOX  
6581750 #8 x 3/4" WHITE - 500/BOX  
6581201 #8 x 1" WHITE - 500/BOX  
65812591 #8 x 1 1/4" WHITE - 500/BOX  
6581501 #8 x 1 1/2" WHITE - 500/BOX

## DOORS & WINDOWS

### PUTTY TAPE

COLORMETRIC



- 43120334 1/8" x 3/4" X 30'—24/CTN
- 43120410 1/8" x 1" X 30'—20/CTN
- 43120615 1/8" x 1 1/2" X 30'—12/CTN

### COLORED PANEL NAILS

1" NAILS OR 1 5/8" NAILS— 6 OZ. PACKAGE



- 655861 1" WHITE
- 656261 1 5/8" WHITE
- 655897 1" MEDIUM BROWN
- 656297 1 5/8" MEDIUM BROWN
- 655817 1" DARK BROWN
- 656217 1 5/8" DARK BROWN

### PHILLIPS RECESS SCREWS

FLAT HEAD - #8 DIAMETER



- 673712 1"—100/BAG, BRASS
- 673711 1"—100/BAG, SILVER

### ENTRY & DEADBOLT COMBO SET

KEYED ALIKE  
4-WAY ADJUSTABLE  
REMOVABLE FACEPLATE



- 641103 STEEL, DRIVE-IN SET
- 641106 BRASS, DRIVE-IN SET

### STAINLESS STEEL ENTRY

4-WAY ADJUSTABLE  
REMOVABLE FACEPLATE



- 641101 STAINLESS STEEL ENTRY

### BRASS ENTRY

4-WAY ADJUSTABLE  
REMOVABLE FACEPLATE



- 641104 BRASS ENTRY

### SINGLE CYLINDER DEADBOLT

4-WAY ADJUSTABLE  
REMOVABLE FACEPLATE



- 641102 STAINLESS STEEL  
SINGLE CYLINDER DEADBOLT
- 641105 POLISHED BRASS  
SINGLE CYLINDER DEADBOLT

### PASSAGE LOCKSET

INTERIOR/POLISHED BRASS



- 648223 PASSAGE LOCKSET  
POLISHED BRASS

### PRIVACY LOCKSET

INTERIOR/POLISHED BRASS



- 648327 PRIVACY LOCKSET  
POLISHED BRASS

**DOORS & WINDOWS**

**PASSAGE LOCKSET**

INTERIOR/STAINLESS STEEL



648221 PASSAGE LOCKSET  
STAINLESS STEEL

**PRIVACY LOCKSET**

INTERIOR/STAINLESS STEEL



648326 PRIVACY LOCKSET STAINLESS  
STAINLESS STEEL

**PASSAGE HANDLE LOCKSET**

NICKEL



648224 PASSAGE HANDLE LOCKSET  
NICKEL

**PRIVACY HANDLE LOCKSET**

NICKEL



648328 PRIVACY HANDLE LOCKSET  
NICKEL

**LATCH SAV'R**

HELPS PREVENT DAMAGE  
TO MOST OUTSWING DOORS



64020001 LATCH SAVER WHITE  
64020002 LATCH SAVER STAINLESS

**NON-MORTISE HINGE**

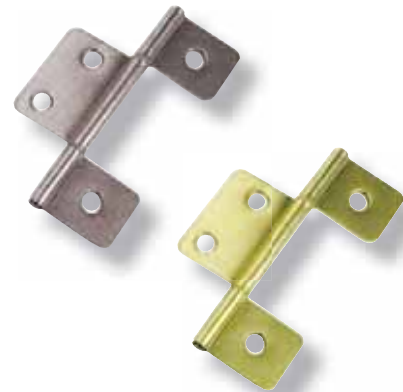

673251 NON-MORTISE HINGE SILVER  
673252 NON-MORTISE HINGE BRASS

**5/16" SQUARE**

CARDED



67803 1 1/4" x 1" MTG. HOLE  
DIMENSION—10/PKG  
67812 1" x 1/16" MTG. HOLE  
DIMENSION—10/PKG

**3/8" HEX**

CARDED



67802 1 1/4" x 1" MTG HOLE  
DIMENSION—10/PKG

**PLASTIC CRANK HANDLE**



67881 1 3/4"  
67750 2 1/4"

**PHILLIPS SILL**



67735R RH CARDED-10/PKG

**AWNING TYPE OPERATOR**



67749R RH—10/PKG

**TRAILER 3/8" SLANT SILL**



67715R RH IN POLY BAG—25/CTN

**CLIP FLAT PLASTIC WITH SCREWS**



67492 CLIP WITH SCREWS 6/PK

**METAL CRANK HANDLE**



67889 1"  
 67889BP 1" 25/PK  
 67795 1 3/4"  
 67795BP 1 3/4" 25/CTN  
 67796 3 1/2"

**SLANT SILL**



67761R RH CARDED—10/PKG  
 67761BP RH PKG/25

**TORQUE BAR BEARING CARDED**



67784 1 1/6" FOR 1/2" BAR-10/PKG

**TORQUE BAR BEARING POLY BAG**

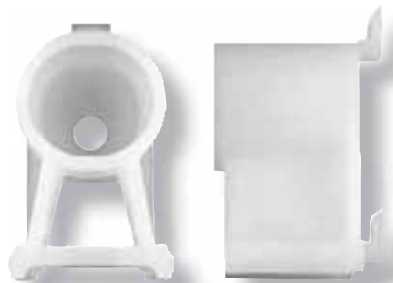

67738 PHILLIPS-25/CTN

**1/2" HUB PROJECTION TORQUE**



67808R RH-EACH

## DOORS & WINDOWS



MANUFACTURED HOUSING

### TORQUE BAR ARM



67785 PHILLIPS

### NYLON

POLY BAG



671703 25/PKG

### TRAILER VENT HINGES

PAIR

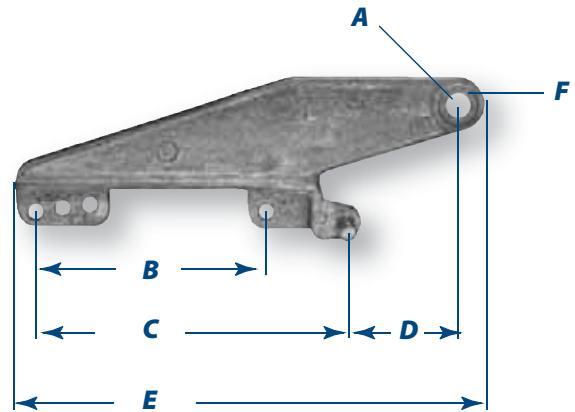

	A	B	C	D	E	F
67835	3/16"	2 3/16"	3 1/8"	1"	4 3/8"	W/STUD

### GRAY SCREEN CORNER



671002G GRAY SCREEN CORNER  
25/PKG

### WHITE GLAZING BEAD



6701001P GLAZING BEAD-PHILLIPS-WHITE

### SCREEN MATERIAL

100' ROLLS



6810032 32" FIBERGLASS SCREEN  
6810036 36" FIBERGLASS SCREEN  
6810048 48" FIBERGLASS SCREEN

Product Availability, Prices and Specifications Subject to Change without Notice

## DOORS & WINDOWS

### EXTENSION

METAL CR



67834 EXTENSION METAL CR 2"

### SCREEN SPRING CLIP

25/PKG



671006 SCREEN SPRING CLIP 25/PKG

### SCREEN FRAME MILL FINISH

12.5' LENGTH



671001M FRAME MILL FINISH 12 1/2'

### SCREEN FRAME WHITE FINISH

12 1/2' LENGTH



671001W FRAME WHITE FINISH 12 1/2'

### WHITE GLAZING BEAD

12' LENGTH



6701002K GLAZING BEAD-KINRO-WHITE  
18000 SERIES

### WHITE SCREEN CORNER



671002W WHITE SCREEN CORNER  
25/PKG

### SCREEN SPLINE

5/32" X 500'



6710045 SCREEN SPLINE 5/32" X 500'

### SCREEN TOOL



671201 SCREEN TOOL

### WHITE GLAZING BEAD

10' LENGTH



6701001K GLAZING BEAD-KINRO-WHITE  
9750 SERIES



# SKYLIGHTS

## Features

- Easy and quick to install
- Reliable waterproof installation
- Polycarbonate-impact resistant
- Self flashing
- For use on asphalt shingle roofs only w/minimum 3/12 pitch

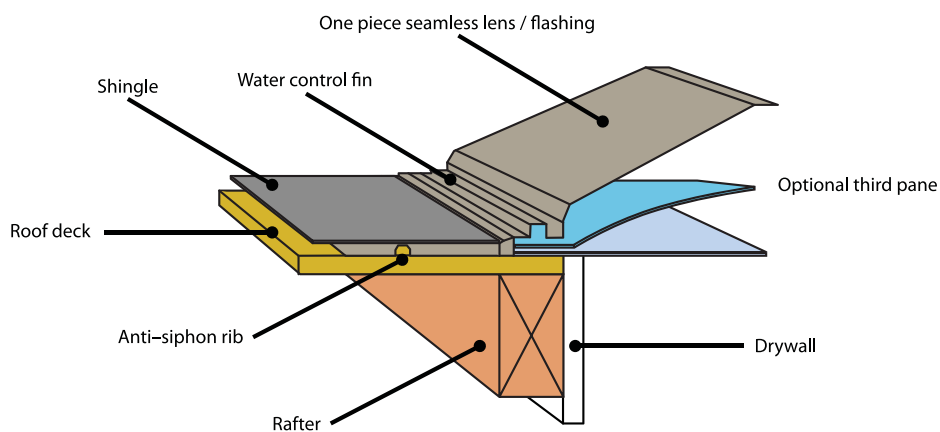





## WATER HEATER DOORS

- Universal, for Gas or Electric
- Metal Exterior Panel
- Welded Frame for Strength & Positive Seal
- White



Blank, 20" x 60"



Blank, 23" x 60"



Louvered, 23" x 60"

69K30001	BLANK 20" x 60"
69K30002	BLANK 23" x 60"
69K30003	LOUVERED 23" x 60"

## DOORS & WINDOWS

MEASURE ROUGH OPENING SIZE • MEASURE CAREFULLY - NO RETURNS ACCEPTED

### INTERIOR DOORS



**Interior Doors**  
Pre-drilled for 2-3/8" Back Set



*WHITE GRAIN EMBOSS*



*LIGHT SMOOTH*



*DARK SMOOTH*



*WHITE GRAIN 6 PANEL*

SIZE	LIGHT SMOOTH	DARK SMOOTH	WHITE GRAIN EMBOSS	WHITE GRAIN 6 PANEL
24" x 78" x 1 <sup>3</sup> / <sub>8</sub> "	642478LT	642478DK	642478FEMBWHT	6424786EWH
24" x 80" x 1 <sup>3</sup> / <sub>8</sub> "	642480LT	642480DK	642480FEMBWHT	6424806EWH
26" x 78" x 1 <sup>3</sup> / <sub>8</sub> "	642678LT	642678DK	X	X
26" x 80" x 1 <sup>3</sup> / <sub>8</sub> "	642680LT	642680DK	X	X
28" x 78" x 1 <sup>3</sup> / <sub>8</sub> "	642878LT	642878DK	642878FEMBWHT	6428786EWH
28" x 80" x 1 <sup>3</sup> / <sub>8</sub> "	642880LT	642880DK	642880FEMBWHT	6428806EWH
30" x 78" x 1 <sup>3</sup> / <sub>8</sub> "	643078LT	643078DK	643078FEMBWHT	6430786EWH
30" x 80" x 1 <sup>3</sup> / <sub>8</sub> "	643080LT	643080DK	643080FEMBWHT	6430806EWH
32" x 78" x 1 <sup>3</sup> / <sub>8</sub> "	X	643278DK	643278FEMBWHT	X
32" x 80" x 1 <sup>3</sup> / <sub>8</sub> "	X	643280DK	643280FEMBWHT	X
36" x 78" x 1 <sup>3</sup> / <sub>8</sub> "	X	X	643678FEMBWHT	X
36" x 80" x 1 <sup>3</sup> / <sub>8</sub> "	X	643680DK	643680FEMBWHT	X

DOORS & WINDOWS

**SHOE/STOP 8 FT.**

3/8" x 5/8" x 8'



*Dark*

- 60500WH WHITE
- 60500LT LIGHT
- 60500DK DARK

**SHOE/STOP 7 FT.**

3/8" x 1 3/8" x 7'



*Light*

- 60300WH WHITE
- 60300LT LIGHT
- 60300DK DARK

**SHOE/STOP 7 FT.**

7/16" x 1 1/16" x 7'



*White*

- 60600WH WHITE
- 60600LT LIGHT
- 60600DK DARK

**BATTEN 8 FT.**

7/8" x 8'



*Dark*

- 60200WH WHITE
- 60200LT LIGHT
- 60200DK DARK

**BATTEN 8 FT.**

1 1/2" x 8'



*Dark*

- 60615WH WHITE
- 60615LT LIGHT
- 60615DK DARK

**BATTEN 8 FT.**

2" x 8'



*Light*

- 60620WH WHITE
- 60620LT LIGHT
- 60620DK DARK

**BATTEN 8 FT.**

3/4" x 8'



*Light*

- 60100WH WHITE
- 60100LT LIGHT
- 60100DK DARK

**INSIDE CORNER 9 FT.**

5/16" X 1" x 8'



*Dark*

- 60900WH WHITE
- 60900LT LIGHT
- 60900DK DARK

**OUTSIDE CORNER 8 FT.**

1" X 1" x 8'



*Dark*

- 601100WH WHITE
- 601100LT LIGHT
- 601100DK DARK

**DOORS & WINDOWS**

**CLOSEUP BEAM 12 FT.**

3/8" x 6" x 12'



White

60700WH WHITE

**CEILING BEAM 10 FT.**

3/16" x 1 7/16" x 10'



White

60400WH WHITE

**CASING 7 FT.**

7/16" x 2 3/16" x 7'



Light

60800WH WHITE  
60800LT LIGHT  
60800DK DARK

**CROWN MOULDING 10 FT.**

2 1/2" x 10'



White

60630WT CROWN MOULDING  
WHITE 2 1/2" x 10'

**DRAWER SINGLE TRACK SET**



678920 DRAWER SINGLE TRACK SET

**KNOB/WALL GUARD**

WITH ADHESIVE



603028 WALL GUARD 3 5/16" WHITE  
603029 WALL GUARD 5" WHITE

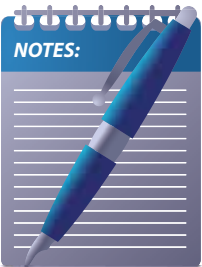

---

---

---

---

---

---

---

---

---

---



Raychem  
**Frostex** PLUS™  
Pipe-Heating System

- Built-In Ground-Fault Protection and Signal Light
- Complies with National Electrical Code
- UL and Factory Approved
- OK for Plastic Pipe
- Two Year Warranty
- Cut - to - Length
- Won't Overheat
- No Thermostat
- OK to Overlap

**PLUG KIT**

**Frostex** PLUS™



549800 PLUG KIT

**HEAT CABLE**  
CONSTANT HEAT

**Frostex** PLUS™



542102 100' REEL  
544250 250' REEL

**PIPE INSULATION**  
6 FT. LENGTH



5238118 6' ID SIZE 1 1/8"  
(FOR USE WITH 3/4" PVC)  
52381 6' ID SIZE 1 1/8"  
(FOR USE WITH 3/4" BLACK  
POLY PIPE)  
523878 6' ID SIZE 7/8"

**FIBERGLASS PIPE  
INSULATION KIT**  
3" WIDE



541625 25' ROLL W/VINYL OUTER  
WRAP - 24/CTN

**ANTI-FREEZE HAND PUMP**  
PUMPS ANTIFREEZE DIRECTLY INTO WATER  
LINES AND SUPPLY TANKS



44501 BLOWOUT PLUG - PLASTIC  
44503 ANTIFREEZE HAND PUMP

**ANTI-FREEZE**  
PROTECTS TO -50° F SAFE FOR COPPER, BRASS,  
AND ALL PLASTICS (EXCEPT ACETATE)



445000 FOR FULL STRENGTH USAGE  
1 GALLON—6/CTN SKID  
QUANTITY: 240 GALLONS

**PLUMBING**

**PIPE HANGER STRAP**

GALVANIZED



116507 GALVANIZED 3/4" x 100'  
28 GAUGE ROLL 10/CARTON

**PIPE HANGER STRAP**

PLASTIC



1113038 PLASTIC, 3/4" x 100',  
.050 GAUGE ROLL

**PIPE CLAMPS**



5034112 FITS 3/4"—1 1/2" WATER LINE  
500/CTN  
505212 FITS 1/2"—1 1/4" WATER LINE  
500/CTN

**STOVE BOLT W/NUT**

20 ROUND HEAD



651434 1/4" x 3/4" W/NUT — 100/BOX

**BALL VALVE**

PVC 3/4" FPT X 3/4" FPT



500007 PVC 3/4" BALL VALVE

**PVC COUPLING**

SLIP X SLIP



504408 3/4"—50/CTN

**CHECK VALVE**

3/4" PVC GLUE IN



5026206 3/4" CHECK VALVE

**PVC ELBOW**

SLIP X SLIP



504505 90° 3/4"—50/CTN

**CONDENSATION DRAIN TRAP**

3/4"

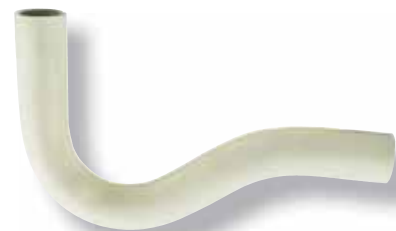

5015411 3/4" CONDENSATION DRAIN TRAP

## PLUMBING

### ABS FOAMCORE PIPE

HEAVY DUTY, THICK WALL, BLACK  
SCHEDULE 40 ABS PIPE



49315104 1 1/2" x 10'  
4932104 2" x 10'  
4933104 3" x 10'  
4933204 3" x 20'

### SCHEDULE 40 PVC PIPE

HEAVY DUTY, THICK WALL, WHITE PVC - DWV PIPE



4963104 3" x 10', 260 PSI, BELLED END

### SCHEDULE 40 PVC RIGID PIPE

20 FT. LENGTHS



4963420 3/4" x 20', BELLED END

### BACKFLOW PREVENTER

BRASS, 3/4" FPT X 3/4" MPT



57234 STAINLESS STEEL SPRINGS  
50/CTN

### ANTI-SIPHON VALVE

3/4" MHT X 3/4" FHT



5111850 CONNECTS TO ANY HOSE  
THREAD BREAK OFF BOLT  
12/CTN

### PIPE SWIVELS & ADAPTERS

3/4"



5030002 3/4" HOSE x 3/4" PIPE SWIVEL  
10/CTN

### SWING CHECK VALVE

DOUBLE CHECK VALVE BRASS - 3/4"



5110543 3/4" SWING CHECK VALVE

### WATER PRESSURE REGULATING VALVE

BRASS - 3/4"



53EB87 REGULATING VALVE

### IN-LINE CHECK VALVE

S. S. SPRING LOADED



519444 BRASS, 3/4" PIPE

## PLUMBING

### GATE VALVES

BRASS - 3/4"



5110133 3/4" REGULAR VALVE  
5110153 IPS NOMINAL; HEAVY DUTY  
SIZE 3/4"

### BOILER DRAIN VALVE

MIP X HOSE



5111702 1/2" MIP x HOSE  
518971 3/4" MIP x HOSE

### HOSE BIBB VALVE

BRASS 3/4" STD. PATTERN, TEE HANDLE



5130217 ROUGH BRASS

### BALL VALVE

3/4" FPT BRASS LVR HD



51252074 BALL VALVE 3/4" FPT BRASS

### FROST-FREE SILCOCK VALVE

BRONZE BODY NICKEL PLATED



5111816 1/2" x 10"

### VENT CAPS

FOR 1 1/4" - 2 1/2" PIPE GALVANIZED STEEL



522084 2 3/8" DIA., REMOVABLE CAP  
50/CTN

### VENT CAP

WHITE PLASTIC, REMOVABLE CAP



522049 1 1/2" DIAMETER—100/CTN



MANUFACTURED HOUSING



**PLUMBING**

**ABS 22 1/2° ELBOW**

ALL HUB (1/16 BEND)



502901 3" x 3" 20/CARTON

**ABS LONG-TURN TEE WYES**

SINGLE



502853 1 1/2" x 1 1/2" x 1 1/2"  
15/CARTON

502858 2" x 2" x 2" 20/CARTON

502852 3" x 3" x 3" 10/CARTON

502837 3" x 3" x 1 1/2" 15/CARTON

502857 3" x 3" x 2" 1/CARTON

**ABS TEES**

SANITARY ALL HUB



502752 1 1/2" x 1 1/2" x 1 1/2"  
100/CARTON

502754 3" x 3" x 3" 30/CARTON

**ABS ELBOWS**

STREET SPIGOT X HUB



502882 3" x 3" 90° 20/CARTON

502892 3" x 3" 45° 20/CARTON

**ABS 45° WYE**

ALL HUB



502824 3" x 3" x 3" 25/CARTON

**ABS 45° ELBOWS**

ALL HUB (1/8 BEND)



502885 1 1/2" x 1 1/2" 100/CARTON

502887 3" x 3" 20/CARTON

**ABS 90° ELBOWS**

LONG TURN ALL HUB



502871 1 1/2" x 1 1/2" 50/CARTON

502873 3" x 3" 10/CARTON

**ABS 90° ELBOWS**

ALL HUB (1/4 BEND)



502876 1 1/2" x 1 1/2" 100/CARTON

502878 3" x 3" 25/CARTON

**ABS P-TRAP**

HUB X HUB W/UNION JOINT



502215 1 1/2" x 1 1/2" 25/CARTON

**ABS P-TRAP**

HUB X HUB W/UNION JOINT



502220 1 1/2" x 1 1/2" x 1/4" 25/CARTON

**ABS FITTING CLEAN OUT ADAPTERS**

SPIGOT X FPT (W/O PLUG)



502922 1 1/2" x 1 1/2" 50/CARTON

502923 2" x 2" 50/CARTON

502924 3" x 3" 25/CARTON

**ABS TRAY PLUG**

SCHEDULE 40



503419 1 1/2" SP x SPSM

## PLUMBING

### ABS CLOSET FLANGE



- 502903 4" x 3" - HUB 25/CARTON
- 506336343 4" x 3" - MPT 25/CARTON
- 506336345 4" x 3" - FPT 25/CARTON

### ABS THREADED PLUGS

MPT



- 502938 1 1/2" 50/CARTON
- 502941 3" 25/CARTON

### ABS P-TRAP ADAPTERS

SPIGOT X SLIP JOINT



- 502975 1 1/2" x 1 1/2" 25/CARTON
- 503409 1 1/2" x 1 1/4" W/TUBE STOP & SJ WASHERS

### ABS COUPLINGS

HUB X HUB



- 502933 1 1/2" x 1 1/2" 100/CARTON
- 502934 2" x 2" 100/CARTON
- 502935 3" x 3" 60/CARTON

### ABS FLUSH BUSHING

SPIGOT X HUB



- 502906 2" x 1 1/2" 50/CARTON

### SEWER RING



- 5211959 SEWER RING 50/CARTON

### FLEXIBLE TRANSITION COUPLINGS

W/STAINLESS STEEL CLAMPS FITS PLASTIC, CAST IRON, COPPER, STEEL & LEAD



- 500540 FITS 1 1/2" PIPE
- 50542 FITS 2" PIPE
- 50543 FITS 3" x 3" PIPE
- 50544 FITS 4" x 3" PIPE 50/CARTON
- 50545 FITS 4" PIPE" 50/CARTON



MANUFACTURED HOUSING

## PLUMBING

### PVC CLEAN OUT ADAPTER

SPIGOT X FPT SCHEDULE 40



505924 3" 25/CARTON

### PVC THREADED PLUG

MPT SCHEDULE 40



505941 3" 25/CARTON

### PVC SANITARY TEE

ALL HUB



505754 3" 30/CARTON

### PVC 90° VENT ELBOW

HUB ¼ BEND



505878 3" x 3" 25/CARTON

### PVC 90° LONG TURN ELBOW

HUB LGTN 90



505873 3" x 3" 10/CARTON

### PVC LONG TURN TEE WYE

ALL HUB



505852 3" 10/CARTON

### PVC 45° ELBOW

HUB X HUB (¼ BEND)



505887 3" 20/CARTON

### PVC 22-1/2° ELBOW

HUB X HUB (¼ BEND)



505901 3" 20/CARTON

### PVC ELBOWS - STREET

SPIGOT X HUB SCHEDULE 40



505882 3" x 3", 90° 20/CARTON

### PVC COUPLING

HUB X HUB SCHEDULE 40



505935 3" x 3" 60/CARTON



MANUFACTURED HOUSING

PLUMBING

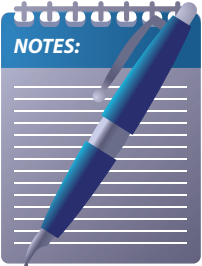

A series of horizontal lines for writing, consisting of a top section with five lines and a larger section with 25 lines below it.

## PLUMBING

### ALL PURPOSE CLEANER



508030 ALL PURPOSE CLEANER ¼ PT  
24/CARTON

### 3-WAY CEMENT

CLEAR FOR USE WITH PVC, CPVC AND ABS PIPE. DAUBER INCLUDED



507115 1 PINT 12/CARTON  
507120 1 QUART 12/CARTON  
5070614 ¼ PINT

### ABS PIPE CEMENT

BLACK MEDIUM BODY, AND SETTING FOR FITTINGS UP TO 6" DIAMETER



507260 CEMENT ABS BLACK ¼ PINT  
24/CARTON  
507265 CEMENT ABS BLACK ½ PINT  
24/CARTON  
507270 CEMENT ABS BLACK 1 PINT  
12/CARTON  
507275 CEMENT ABS BLACK 1 QUART  
12/CARTON

### PLASTIC PIPE PRIMER/CLEANER

USE PRIOR TO APPLYING SOLVENT



508005 ½ PINT W/DAUBER 24/CARTON  
508030 ¼ PINT W/DAUBER 24/CARTON

### PLASTIC PIPE PVC CEMENT

ALL WEATHER - CLEAR



507070 PINT FOR SCH. 40 & 80  
UP TO 6" DIA.-12/CTN

### PVC ALL PURPOSE CEMENT



507051 1 PINT 12/CARTON

### PIPE JOINT COMPOUND



502000 PIPE JOINT COMPOUND  
2 OZ TUBE 12/CARTON

### RAIN-R-SHINE PVC CEMENT



501044 CEMENT RAIN-R-SHINE  
¼ PINT 24/CARTON  
501045 CEMENT RAIN-R-SHINE  
½ PINT 24/CARTON



MANUFACTURED HOUSING

PLUMBING

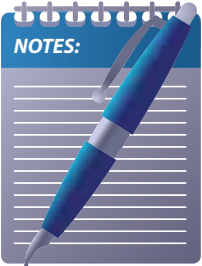

A series of horizontal blue lines for writing, starting from the top right and extending across the page.



**MOBILE HOME ELECTRIC**

6-Year Limited Tank/Parts Warranty\*

**APPROVED FOR MANUFACTURED HOUSING**

- All residential electric water heaters are compliant with HUD Standards for mobile homes/manufactured homes.

**LONG LASTING HEATING ELEMENTS**

- Screw-in, direct immersion, 3500 watt, 240 volt heating elements for maximum efficiency (20U unit has 1 element).

**CSA CERTIFIED AND ASME RATED T&P RELIEF VALVE**

- Conveniently located on the side of the tank to facilitate piping to a drain or external to the building.

**BLUE DIAMOND® GLASS COATING**

- Provides superior corrosion resistance compared to industry standard glass lining.

**COREGARD™ ANODE ROD**

- Our anode rods have a stainless steel core that extends the life of the anode rod allowing superior tank protection longer than standard anode rods.

**ENHANCED BRASS DRAIN VALVE**

- Our residential water heaters have a solid brass, tamper resistant, enhanced flow, ball type, drain valve. The drain valve uses a standard female hose fitting that allows for fast and easy draining during maintenance. The drain valve is designed for easy operation, this valve includes an integral screwdriver slot that features a ¼" turn (open/close) radius, which not only permits full straight-through water flow but also a quick and positive shut off.

**SIDE WATER CONNECTIONS**

- For ease of installation in Mobile Home Applications (except for 19 and 50 gallon models)

**CODE COMPLIANCE**

- Meets UBC, CEC and HUD National Codes
- Meets the thermal efficiency and standby loss requirements of the U. S. Department of Energy and current edition of ASHRA/IESNA 90.1.
- Complies with the Federal Energy Conservation Standards effective April 16, 2015, in accordance with the Energy Policy and Conservation Act (EPCA) as amended.

**CERTIFIED TO UL 174 FOR HOUSEHOLD ELECTRIC WATER HEATERS**

**CSA CERTIFIED AND ASME RATED T&P RELIEF VALVE**

**DESIGN-LISTED BY CSA INTERNATIONAL**

- Certified at 300 PSI test pressure and 150 PSI working pressure.
- Listed according to ANSI Z21.10.1- CSA 4.1 standards governing storage tank-type water heaters.



\*For complete warranty information consult the written warranty of American Water Heater found at [www.americanwaterheater.com](http://www.americanwaterheater.com) or call (800.999.9515)

# INTERIOR PLUMBING



## MOBILE HOME ELECTRIC

**6-Year Limited Tank/Parts Warranty\***

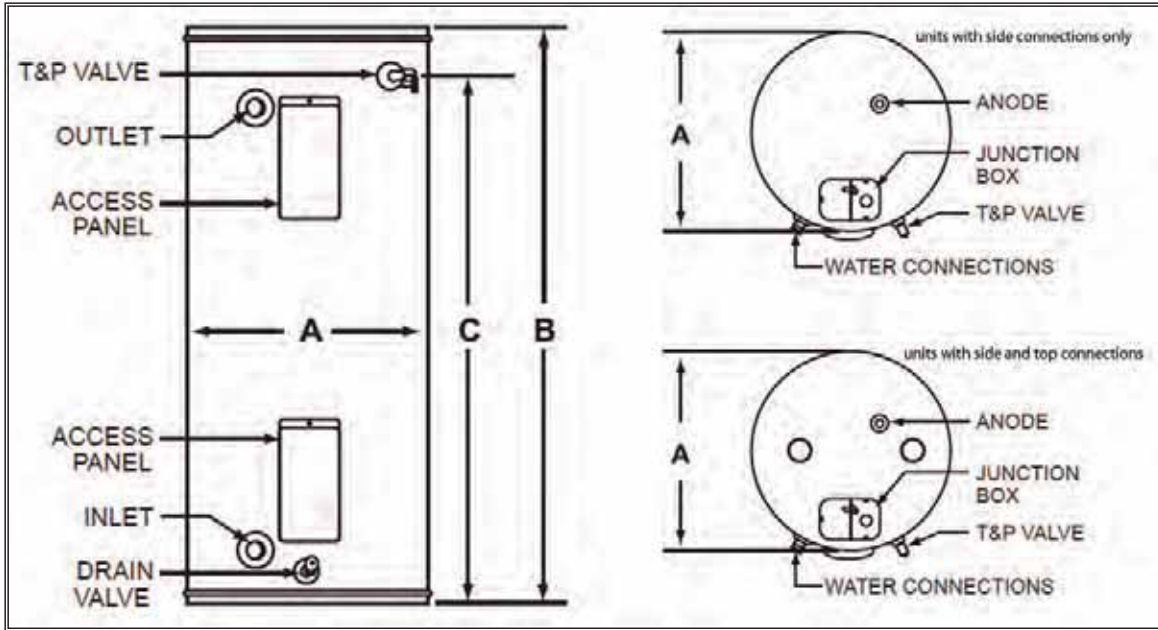

Dimensions and specifications subject to change without notice in accordance with our policy of continuous product improvement. Dimensions on all charts shown in inches. "Dual element models are wired for non-simultaneous element operation." 3/4" water connections. Available with side T&P only.

WATER HEATER MODEL NUMBER	MANUFACTURES MODEL NUMBER	GALLON CAPACITY	GPH RECOVERY 90° RISE	FIRST HOUR RATING	ENERGY FACTOR (EF)	ELEMENT WATTAGE UPPER/LOWER	DIAMETER (INCHES)	HEIGHT TO TOP OF HEATER (INCHES)	HEIGHT TO SIDE T&P (INCHES)	APPROX. SHIPPING WEIGHT (LBS)
56010008 <sup>++</sup>	E61-20U-015SV	19	7.0	N/A	N/A	1500	8"	25"	18 1/2"	65 lbs.
56010009	MHE6-30L-035D	28	16.0	40	0.95	3500/3500	22"	30"	21 3/4"	96 lbs.
56010006	MHE6-30H-035D	30	16.0	42	0.95	3500/3500	19"	46 3/4"	39 1/2"	98 lbs.
56010007	MHE6-40R-035D	40	16.0	52	0.95	3500/3500	22"	50"	40 3/4"	109 lbs.

<sup>++</sup> water heater with top and side plumbing connections

\*For complete warranty information consult the written limited warranty of American Water Heater found at [www.americanwaterheater.com](http://www.americanwaterheater.com) or call (800.999.9515)





**RESIDENTIAL GAS MOBILE HOME  
FVIR ATMOSPHERIC  
6-Year Limited Tank/Parts Warranty\***

**CONVERTIBLE GAS CONTROL FOR  
NATURAL OR PROPANE GAS**

- For flexibility to meet the needs of different mobile home installations.
- All models ship from the factory for use with natural gas, a complete propane burner is supplied for converting to propane gas.
- Conversion must be completed by qualified technician.

**GREEN CHOICE® GAS BURNER**

- Patented eco-friendly burner design reduces NOx emissions by up to 33% and complies with Low-NOx emission requirements of less than 40 ng/J.

**BLUE DIAMOND® GLASS COATING**

- Provides superior corrosion resistance compared to industry standard glass lining.

**COREGARD™ ANODE ROD**

- Our anode rods have a stainless steel core that extends the life of the anode rod allowing superior tank protection longer than standard anode rods.

**ENHANCED BRASS DRAIN VALVE**

- Our residential water heaters have a solid brass, tamper resistant, enhanced flow, ball type, drain valve. The drain valve uses a standard female hose fitting that allows for fast and easy draining during maintenance.

The drain valve is designed for easy operation, this valve includes an integral screwdriver slot that features a ¼" turn (open/close) radius, which not only permits full straight-through water flow but also a quick and positive shut off.

**CODE COMPLIANCE**

- Meets UBC, CEC and HUD National Codes
- Meets the thermal efficiency and standby loss requirements of the U. S. Department of Energy and current edition of ASHRA/IESNA 90.1.
- Complies with the Federal Energy Conservation Standards effective April 16, 2015, in accordance with the Energy Policy and Conservation Act (EPCA) as amended.

**COMPLIES WITH HUD STANDARDS  
FOR MANUFACTURED HOUSING  
INSTALLATION**

**CSA CERTIFIED AND ASME RATED  
T&P RELIEF VALVE**

**MAXIMUM HYDROSTATIC  
WORKING PRESSURE 150 PSI**



\*For complete warranty information consult the written warranty of American Water Heater found at [www.americanwaterheater.com](http://www.americanwaterheater.com) or call (800.999.9515)



**RESIDENTIAL GAS MOBILE HOME  
FVIR ATMOSPHERIC  
6-Year Limited Tank/Parts Warranty\***

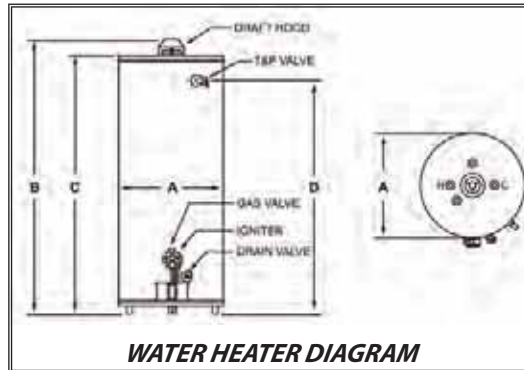

WATER HEATER MODEL NUMBER	MANUFACTURES MODEL NUMBER	GALLON CAPACITY	INPUT BTU PER HOUR		GPH RECOVERY 90° RISE		VENT DIAM.	ENERGY FACTOR (EF)	JACKET DIAM.	HEIGHT TO TOP OF HEATER (INCHES)	HEIGHT TO SIDE T&P (INCHES)	APPROX. SHIPPING WEIGHT (LBS)
			NAT.	LP	NAT.	LP						
56020006	MHG62-30T30	30	30,000	29,000	31	31	3"or 4"	0.63	17 ¾"	56 ½"	49 ¼"	129 lbs.
56020007	MHG62-40T40	40	40,000	36,000	41	41	3"or 4"	0.62	19 ¾"	58 ½"	51 ¾"	153 lbs.

All models ship from the factory for use with natural gas, a complete propane burner is supplied for converting to propane gas, which must be completed by a qualified technician. All models are certified from sea level to 10,000 ft. elevation. Dimensions and specifications subject to change without notice, in accordance with our policy of continuous product improvement.



**ROOF JACK ATMOSPHERIC VENT—MEASURE  
TOP OF WATER HEATER TO ROOF FLANGE**

ACCESSORY MODEL NUMBER	MANUFACTURES MODEL NUMBER	DESCRIPTION
56030005	9002964005	ROOF STACK-WH-GAS 12"
56030006	9002965005	ROOF STACK-WH-GAS 12"-32"
56030007	9002966005	ROOF STACK-WH-GAS 32"-60"
56030008	9002967005	ROOF STACK-WH-GAS 60"-95"
56030003	9002588005	OUTDOOR VENT EXTENSION 18"

\*For complete warranty information consult the written warranty of American Water Heater found at [www.americanwaterheater.com](http://www.americanwaterheater.com) or call (800.999.9515)



**MOBILE HOME  
DIRECT VENT**  
6-Year Limited Tank/2 Year Parts Warranty\*

**CONVERTIBLE GAS CONTROL FOR NATURAL OR PROPANE GAS**

- For flexibility to meet the needs of different mobile home installations.
- All models ship from the factory for use with natural gas, a complete propane burner is supplied for converting to propane gas.
- Conversion must be completed by qualified technician.

**GREEN CHOICE® GAS BURNER**

- Patented eco-friendly burner design reduces NOx emissions by up to 33% and complies with Low-NOx emission requirements of less than 40 ng/J.

**BLUE DIAMOND® GLASS COATING**

- Provides superior corrosion resistance compared to industry standard glass lining.

**COREGARD™ ANODE ROD**

- Our anode rods have a stainless steel core that extends the life of the anode rod allowing superior tank protection longer than standard anode rods.

**ENHANCED BRASS DRAIN VALVE**

- Our residential water heaters have a solid brass, tamper resistant, enhanced flow, ball type, drain valve. The drain valve uses a standard female hose fitting that allows for fast and easy draining during maintenance.

The drain valve is designed for easy operation, this valve includes an integral screwdriver slot that features a ¼" turn (open/close) radius, which not only permits full straight-through water flow but also a quick and positive shut off.

**CODE COMPLIANCE**

- Meets UBC, CEC and HUD National Codes
- Meets the thermal efficiency and standby loss requirements of the U. S. Department of Energy and current edition of ASHRA/IESNA 90.1.
- Complies with the Federal Energy Conservation Standards effective April 16, 2015, in accordance with the Energy Policy and Conservation Act (EPCA) as amended.

**COMPLIES WITH HUD STANDARDS FOR MANUFACTURED HOUSING INSTALLATION**

**CSA CERTIFIED AND ASME RATED T&P RELIEF VALVE**

**MAXIMUM HYDROSTATIC WORKING PRESSURE 150 PSI**



\*For complete warranty information consult the written warranty of American Water Heater found at [www.americanwaterheater.com](http://www.americanwaterheater.com) or call (800.999.9515)



**MOBILE HOME  
DIRECT VENT**  
6-Year Limited Tank/2 Year Parts Warranty\*

**APPROVED ROOF JACK KITS**

Direct Vent Manufactured Housing water heaters must be installed using one of these approved Roof Jack Kits, which must be ordered separately. "Min." and "Max." dimensions indicate kit adjustability for varying vent distance, as shown in drawing.

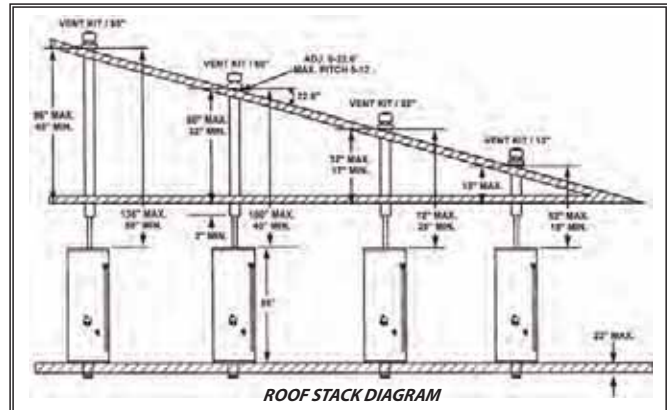
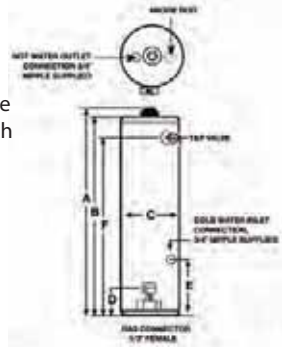

WATER HEATER MODEL NUMBER	MANUFACTURES MODEL NUMBER	GALLON CAPACITY	INPUT BTU PER HOUR		GPH RECOVERY 90° RISE		VENT DIAM.	ENERGY FACTOR (EF)	JACKET DIAM.	HEIGHT TO TOP OF HEATER (INCHES)	HEIGHT TO SIDE T&P (INCHES)	APPROX. SHIPPING WEIGHT (LBS)
			NAT.	LP	NAT.	LP						
56020008	MHDV-62-30T30-3NV	30	30,000	29,000	31.0	31.0	3"	0.63	18	58"	52 1/2"	129 lbs.
56020009	MHDV-62-40T32-3NV	40	32,000	29,000	33.0	33.0	3"	0.62	20	58 3/4"	52 1/4"	153 lbs.

Water connection—3/4" on all models. No option available for top T&P. All models approved for installation from seal level to 5,400 ft. elevation. All models ship from the factory for use with natural gas, a complete propane burner is supplied for converting to propane gas. Dimensions and specification subject to change without notice in accordance with our policy of continuous product improvement. Conversion must be completed by qualified technician.



**ROOF JACK DIRECT VENT—MEASURE TOP OF WATER HEATER TO ROOF FLANGE**



**AIR INLET KIT—DIRECT VENT BASEMENT/CRAWL**

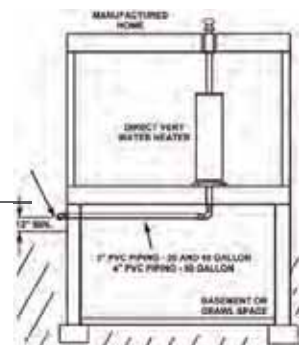

ACCESSORY MODEL NUMBER	MANUFACTURES MODEL NUMBER	DESCRIPTION
56030005	9002964005	ROOF STACK—WH—GAS 12"
56030006	9002965005	ROOF STACK—WH—GAS 12"—32"
56030007	9002966005	ROOF STACK—WH—GAS 32"—60"
56030008	9002967005	ROOF STACK—WH—GAS 60"—95"
56030003	9002588005	OUTDOOR VENT EXTENSION 18"
56030009	9002968005	AIR INLET KIT—DIRECT VENT—BASEMENT/CRAWL

\*For complete warranty information consult the written warranty of American Water Heater found at [www.americanwaterheater.com](http://www.americanwaterheater.com) or call (800.999.9515)

## WATER HEATER DOORS

- *Universal, for Gas or Electric*
- *Metal Exterior Panel*
- *Welded Frame for Strength & Positive Seal*
- *White*



Blank 20" x 60"



Blank 23" x 60"



Louvered 23" x 60"

- 69K30001 BLANK 20" X 60"
- 69K30002 BLANK 23" X 60"
- 69K30003 LOUVERED 23" X 60"

## INTERIOR PLUMBING

### TEMPERATURE RELIEF VALVE

BRASS BODY, TEFLON COATED ACTUATOR



5710471 LONG BODY  
3/4" M x 3/4" F OUTLET

### DIELECTRIC NIPPLE

2 PER PACK



570325 3/4" MPT x 3/4" MPT

### EXTERIOR GAS CONNECTOR

STAINLESS STEEL CORRUGATED TUBING



603634 1" O.D. (3/4" I.D.)  
W/ 3/4" FITTINGS  
36" LONG W/PVC COATING

### SCREW-IN ELEMENT SOCKET WRENCH



579932 FITS 1 1/2" NUT

### SCREW-IN IMMERSION ELEMENT

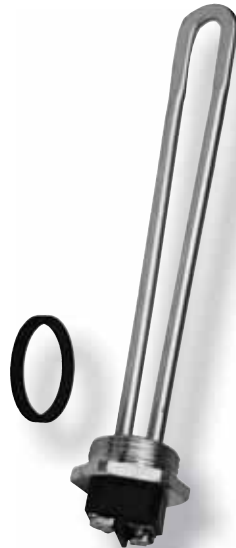

572143 120V 1500W ELEMENT  
572183 120V 1750W ELEMENT  
572283 240V 3500W ELEMENT  
572343 240V 4500W ELEMENT

### THERMOSTATS

U.L. LISTED, 1 YEAR WARRANTY



577843 SINGLE POLE ELEMENT W/HLC  
577863 UPPER W/HIGH LIMIT  
577723 SINGLE POLE, LOWER ELEMENT



# AQUATIC

## Tubs and Showers

*Designed Especially for Manufactured Homes*

**Aquatic**, the largest producer of everyday bath products in the USA, now offers through **Style Crest®**, tubs and showers designed specifically for manufactured homes!

### **Product Features:**

- Attractive subtle contours and patterns
- Slip resistant bottom surfaces in all units
- Strong base with ArmorCore™ support
- AcrylX™ applied acrylic for clean, seamless appearance and easy cleaning
- 2 stage resin/fiber base coat for extra strength
- Strengthened with ArmorCore™ for unmatched strength
- Rugged integral front skirt
- Rigorous quality control process ensures consistently high quality
- Made in the United States of America



**5 Year and 10 Year Limited Warranties**  
Against manufacturing defects

**THE BATH PEOPLE**

## BATH 27" x 54"

Manufacturers Dimensions  
27 1/8" x 54" x 15"



53111101-1	27" X 54" TUB LH DRAIN BOXED-WHITE
53111101-2	27" X 54" TUB LH DRAIN BOXED-ALMOND
53111102-1	27" X 54" TUB RH DRAIN BOXED-WHITE
53111102-2	27" X 54" TUB RH DRAIN BOXED-ALMOND
53111103-1	27" X 54" TUB CENTER DRAIN BOXED-WHITE
53111103-2	27" X 54" TUB CENTER DRAIN BOXED-ALMOND

### FEATURES

- Alcove bath
- Ergonomic backrest
- Integral tiling flange
- Integral skirt
- Slip resistant textured bottom
- Left, right or center drain
- AcrylX™ surface
- Almond and white

**5 Year Limited Warranty**



## SHOWER PAN 27" x 54"

Manufacturers Dimensions  
27 1/8" x 54" x 15"



53111105-1	27" X 54" SHOWER BASE BOXED-WHITE
53111105-2	27" X 54" SHOWER BASE BOXED-ALMOND

### FEATURES

- Shower pan
- Center back drain
- 4" threshold
- Slip resistant textured bottom
- AcrylX™ surface
- Almond and white

**5 Year Limited Warranty**



## WALL SET 27" x 54"

Manufacturers Dimensions  
27 1/8" x 54" x 58"



53111104-1	27" X 54" WALL KIT BOXED-WHITE
53111104-2	27" X 54" WALL KIT BOXED-ALMOND

### FEATURES

- Smooth wall finish
- Integral toiletry shelves
- Wall set fits the following Aquatic models:  
27" x 54" tub  
27" x 54" shower pan
- AcrylX™ surface
- Almond and white

**5 Year Limited Warranty**







### GARDEN TUB 41" x 54"

Manufacturers Dimensions  
41" x 54 1/4" x 23 1/8"



### FEATURES

- Garden tub
  - Ergonomic backrest
  - 6 1/2" wainscot
  - Integral tiling flange
  - Integral skirt
  - Slip resistant textured bottom
  - Center drain
  - AcrylX™ surface
  - Almond and white
- 5 Year Limited Warranty**

53111110-1 41" X 54" TUB CENTER DRAIN BOXED-WHITE  
 53111110-2 41" X 54" TUB CENTER DRAIN BOXED-ALMOND



### GARDEN TUB 41" x 60"

Manufacturers Dimensions  
40 3/4" x 60" x 23"



### FEATURES

- Garden tub
  - Ergonomic backrest
  - 6" wainscot
  - Integral tiling flange
  - Integral skirt
  - Slip resistant textured bottom
  - Center drain
  - AcrylX™ surface
  - Almond and white
- 5 Year Limited Warranty**

53111107-1 41" X 60" TUB CENTER DRAIN BOXED-WHITE  
 53111107-2 41" X 60" TUB CENTER DRAIN BOXED-ALMOND

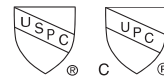

### GARDEN TUB 48" x 60"

Manufacturers Dimensions  
48" x 60" x 27 3/4"



### FEATURES

- Garden tub
  - Ergonomic backrest
  - 6 1/2" wainscot
  - Integral tiling flange
  - Integral skirt
  - Slip resistant textured bottom
  - Center drain
  - AcrylX™ surface
  - Almond and white
- 5 Year Limited Warranty**

53111108-1 48" X 60" TUB CENTER DRAIN BOXED-WHITE  
 53111108-2 48" X 60" TUB CENTER DRAIN BOXED-ALMOND



## A<sup>2</sup> COMPOSITE SHOWER

Manufacturers Dimensions  
32" x 32" x 76"

Lightweight and durable, our A Composite is an engineered compound of resin, glass and special fillers formed into sheets. These sheets are then placed under high pressure and heat to liquify the compound, allowing it to flow and take the shape of almost any form imaginable. The results are simple, stylish and a snap to install.



## FEATURES

- **Durable high gloss finish**
  - *Smooth wall, 4 piece molded sectionals*
  - *Pre-Leveled base*
  - *Caulkless installation*
  - *Leakproof right angle joint flanges*
  - *Easy wedge & lock installation*
  - *Multiple integral soap shelves*
  - *Center drain*
  - *Slip resistant textured bottom*
  - *AcrylX™ surface*
  - *White*
- 10 Year Limited Warranty**



- 53111109-3A 32" X 32" SHOWER BASE-WHITE
- 53111109-3B 32" X 74" SHOWER WALL BACK-WHITE
- 53111109-3C 32" X 74" SHOWER WALL SIDE-WHITE

## INTERIOR PLUMBING



### STANDARD TUBS

- Calfgain Finish Hides Scuffs & Mars
- Reinforcement at Drain for Increased Support
- Prevents Drain Area Cracking
- Front Apron
- 12" Inside Depth
- 1 Year Warranty



5327541L WHITE 27" x 54" LH  
5327541R WHITE 27" x 54" RH  
5327542L ALMOND 27" x 54" LH  
5327542R ALMOND 27" x 54" RH



### HEAVY DUTY TUBS

- Heaviest Gauge ABS Offered
- Calfgain Finish Hides Scuffs & Mars
- Reinforcement at Drain for Increased Support
- Prevents Drain Area Cracking
- Foam Support Base - (Injected Molded Foam vs. Cut-Block) for Twice the Support Strength. Glued to Tub Base
- Front Apron
- 12" Inside Depth
- 5 Year Warranty



5327543C WHITE 27" x 54" CENTER DRAIN  
5327544C ALMOND 27" x 54" CENTER DRAIN  
5330001L WHITE 27" x 54" LH  
5330001R WHITE 27" x 54" RH  
5330012L ALMOND 27" x 54" LH  
5330012R ALMOND 27" x 54" RH



### GARDEN TUBS

- 1/8" Masonite Around Entire Bowl & Drain for Increased Strength
- Additional Plastic Reinforcement Around Drain
- Support Legs are Rigid PVC Pipe
- 14" Inside Depth
- ABS
- Center Drain



### HEAVY DUTY

5330041 WHITE 40" x 54" W/OUTSIDE STEP  
5330042 ALMOND 40" x 54" W/OUTSIDE STEP



**ONE PIECE SURROUND**

- Calgrain Finish & Tile Look
- All ABS Stock Formed From .060 Sheet
- Flanged Lip at Bottom - Easier Installation & Straight Wall Finish
- 57 3/4" Height

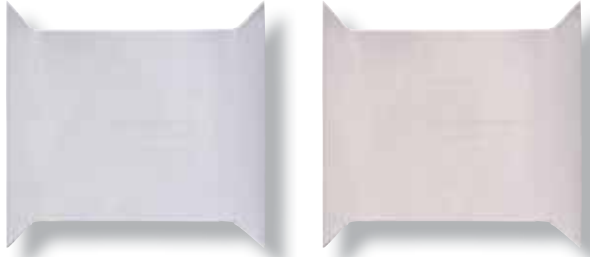

- 5330061 WHITE FOR 27" x 54" TUB
- 5330062 ALMOND FOR 27" x 54" TUB
- 5330071 WHITE FOR 40" x 54" GARDEN TUB
- 5330072 ALMOND FOR 40" x 54" GARDEN TUB



**THREE PIECE SURROUND**

- Calgrain Finish & Tile Look
- All ABS Stock Formed From .060 Sheet
- Flanged Lip at Bottom - Easier Installation & Straight Wall Finish
- 57 3/4" Height

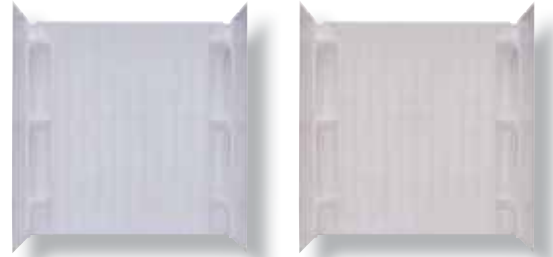

- 5330091 WHITE PANELS FOR 40" x 54" TUB (REQUIRES CORNER CADDY - 5330101)
- 5330092 ALMOND PANELS FOR 40" x 54" TUB (REQUIRES CORNER CADDY - 5330102)
- 5330101 WHITE CORNER CADDY FOR 3-PIECE SURROUND
- 5330102 ALMOND CORNER CADDY FOR 3-PIECE SURROUND
- 5332754A ALMOND PANELS FOR 27" x 54" TUB
- 5332754W WHITE PANELS FOR 27" x 54" TUB



**ONE PIECE SHOWER PAN**



- 5332321 WHITE 32" x 32"
- 5332322 ALMOND 32" x 32"
- 535428WLH WHITE LH 54" x 28"
- 535428WRH WHITE RH 54" x 28"
- 535428ALH ALMOND LH 54" x 28"
- 535428ARH ALMOND RH 54" x 28"



**SHOWER SURROUND**



- 5302321 WHITE 68"H x 32"W x 32"D
- 5302322 ALMOND 68"H x 32"W x 32"D
- 5335428ALM ALMOND 68"H x 54"W x 28"D MULTI-PIECE SURROUND
- 5335428W WHITE 68"H x 54"W x 28"D MULTI-PIECE SURROUND

# PERMALUX™ TUBS

## PERMALUX STANDARD TUBS



- **Rigid**
- **High Impact Strength**
- **Patented 2 Part Composite Material**
- **Acrylic Polymer Provides Superior Gloss Finish**
- **Cleaner, Chemical and Stain Resistant**
- **No Chipping, Peeling or "Spider Webs"**
- **5 Year Warranty**

532754LHB	ALMOND 27" x 54" / LH DRAIN
532754LHW	WHITE 27" x 54" / LH DRAIN
532754RHB	ALMOND 27" x 54" / RH DRAIN
532754RHW	WHITE 27" x 54" / RH DRAIN

# PERMALUX™ TUBS

## PERMALUX GARDEN TUBS



- **Rigid**
- **High Impact Strength**
- **Patented 2 Part Composite Material**
- **Acrylic Polymer Provides Superior Gloss Finish**
- **Cleaner, Chemical and Stain Resistant**
- **No Chipping, Peeling or "Spider Webs"**
- **5 Year Warranty**

534054B ALMOND 40" x 54" W/ STEP  
534054W WHITE 40" x 54" W/STEP  
534260B ALMOND 42" x 60" W/O STEP  
534260W WHITE 42" x 60" W/O STEP

# Bath Shower Door *Series*

## *Expensive in Style, Economical in Price*

The **By-Pass Shower Door** features exclusive "Free Flow" sill track with floating nylon guides attached to the door panels, which allows for both positive door traction, and easy cleaning.

A classic look with a solid touch is created with towel bars that are set in cast brackets and finished front and back.



The **Hinge Shower Door** offers an innovative alternative to traditional hinge-style doors. Internalized hinge to improve function, strength, durability and look.

- The doors have been sized so that adjustments are from -0" to +1½".
- The up to ¾" out-of-square adjustment on each wall will work better in fiberglass stalls



5327501	SHOWER DOOR	28" x 65"	HINGE
5331501	SHOWER DOOR	32" x 65"	HINGE
5354010	SHOWER DOOR	54" x 57"	BYPASS
5354011	SHOWER DOOR	54" x 65"	BYPASS

## GLASS SHOWER DOOR MATCHUP

SHOWER DOOR	DESCRIPTION	FITS BETTER BATH BASE	WITH BETTER BATH WALL KITS	FITS AQUATIC BASE	AQUATIC W/BETTER BATH SURROUNDS	W/AQUATIC WALL KIT
5327501	SHOWER DOOR 28"X 65" HINGED	NA	NA	53111109-3A	NA	53111109-3B/C
5331501	SHOWER DOOR 32"X 65" HINGED	5332321 5332322	5302321 5302322	NA		NA
5354010	SHOWER DOOR 54"X 57" BYPASS	532754xx 5330001x 5330012x 5340542 5330041 5330042 5330051 5330052 532754xx 534505x	5302321 5302322 5330061 530062 5330071 5330072	53111101-1 53111110-1 53111110-1P 53111110-2 53111110-2P 53111101-2 53111102-1 53111102-2 53111103-1 53111103-2	5302321 5302322 5330061 530062 5330071 5330072	53111104-1 53111104-2
5354011	Shower Door 54"x 65" BYPASS	535428xxx	5335428xxx	53111105-1 53111105-2		53111104-1 53111104-2

**NOTES:** DOORS WILL HAVE 1 1/2" OVERLAY ON AQUATIC 54" SURROUND

### RIVETS



- 53139 ALMOND RIVETS  
25/BAG
- 53140 WHITE RIVETS  
25/BAG

### TUB TRIM KIT

CHROME



- 534964 REG. 54" TUB TRIM KIT
- 534860 GARDEN TUB TRIM KIT
- 53120 TUB MOULDING  
BAR 120"
- 53301 END CAP LEFT
- 53305 END CAP RIGHT
- 53309 INSIDE CORNER

### TUB MOULDING

VINYL 7'



- 6001002 TUB MOULDING  
WHITE 8'

### SHOWER CURTAIN ROD



- 522012 ALUMINUM, 60"  
ROD W/FLANGE



## INTERIOR PLUMBING

### BATHTUB DRAIN

1-1/2" POPSTOP - CHROME FINISH FEATURES  
POSITIVE PUSH/PULL SEAL PLUG COMPLETELY  
REMOVABLE FOR CLEANING



52227 1 1/2" BATHTUB DRAIN  
(SHOWN)  
52200112 GASKET NEEDED FOR  
52227

### SHOWER STRAINER



5233R45 SHOWER STRAINER 3 1/2"

### METAL DRAIN & PLUG



522109 DRAIN & PLUG

### AUTOMATIC ANTI-SIPHON TRAP VENT



522020 PRO-VENT WITH 1 1/2" MPT  
50/PK

### CHROME C.O. PLUG

1 1/4" X 5" NO OVERFLOW



532112 CHROME C.O. PLUG W  
CHAIN & STOPPER

### TOILET SEATS

PLASTIC OR WOODEN



53201021 BONE - PLASTIC  
53202030 WHITE - PLASTIC  
535232 WHITE - WOODEN

### LAVATORY SINKS

PLASTIC, OVAL 17" X 20"



53163701 WHITE W/OVERFLOW  
53163702 IVORY W/OVERFLOW  
5316370W WHITE W/O-OVERFLOW  
5316370V IVORY W/O-OVERFLOW

### LAVATORY SINKS

PLASTIC, SQUARE SELF-RIM NO OVERFLOW



5316270W WHITE, 16" x 20"  
5316270I IVORY, 16" x 20"

### LAVATORY SINKS



53172001 LAVATORY-17" x 20"  
PORCELAIN-WHITE  
53010001 LAVATORY-17" x 20"  
PORCELAIN COVERED  
STEEL-IVORY

## INTERIOR PLUMBING

### TUBULAR TAILPIECE CHROME PLATED DRAIN CONNECTION



50413 KITCHEN SINK, 1 1/2" x 6"  
BRASS FLANGED, 22 GA.

### TUBULAR TAILPIECE CHROME PLATED DRAIN CONNECTION



50414 BATHROOM SINK, 1 1/4" x 6"

### HOSE WASHER

3/4" VINYL



53493 3/4" HOSE WASHER, VINYL 10/PK

### KITCHEN SINK STRAINER ASSEMBLY



5220002 3 1/2" TWIST TOP BASKET  
STRAINER

### KITCHEN SINK STRAINER BASKET ONLY



5220003 BASKET ONLY FOR 5220002

### SINK STRAINER

STAINLESS STEEL



522115 SINK STRAINER  
STAINLESS STEEL 4"

### PLUG PO CHROME 5"



532105 PLUG PO CHROME 5"

### DOUBLE KITCHEN SINKS

NICKEL STAINLESS STEEL, SELF RIM  
4 FAUCET HOLES ON 4" CTRS



533319 STAINLESS STEEL  
33" x 19" x 6" DEPTH

533320 STAINLESS STEEL  
33" x 19" x 7" DEPTH

533321 STAINLESS STEEL  
33" x 19" x 8" DEPTH

5360013 SINK RIM CLAMP 10/BAG

### WASTE OUTLET

WITH DISHWASHER BRANCH



502267 UNIVERSAL, 16"-21"  
TELESCOPIC

## INTERIOR PLUMBING

### WASTE OUTLET

WITH OUT DISHWASHER BRANCH



502260 UNIVERSAL WASTE OUTLET,  
16"-24", TELESCOPIC

### STRAINER ADAPTERS

1 1/2" X 1" SWIVEL



50080 STRAINER ADAPTER  
1 1/2" x 1" SWVL  
501122 STRAINER ADAPTER  
1 1/2" x 2" SWVL  
50300001 GASKET FOR 501122

### DRAIN TUB TIP TOE W/LOCKNUT

CHROMER



53878 DRAIN TIP TOE W/LOCKNUT

### SLIP JOINT NUT/WASHER 1 1/2"



503492 SLIP JOINT NUT/WASHER

### WAX GASKETS

FOR SETTING CLOSET BOWLS



524005 WAX GASKET W/FLANGE  
FITS 3"-4" WASTE LINES  
24/CTN  
524000 WAX GASKET 48/CTN

### TOILET BOWL / TANK

ACUACER PORCELAIN - 12" 1.6 GALLON WATER  
SAVING COMPLIES WITH THE COMPREHENSIVE  
NATIONAL ENERGY POLICY ACT OF 1992



533161 BOWL WHITE  
534161 TANK WHITE W/ACC.

### TOILET BOWL / TANK COMPLETE UNIT



53582529 TOILET COMPLETE WHITE  
1.6 GPF  
53271621 TOILET COMPLETE WHITE  
1.28 GPF \*  
(\* AVAILABLE IN TEXAS ONLY)

### BALLCOCK W/WATER LEVEL WITH ADJUSTING SCREW

NON-CORRODING



50401 REGULAR, 8 1/2"  
OVERALL HT.  
6 3/16" CRITICAL LEVEL

### BALLCOCK FLUIDMASTER



5081254 FLUIDMASTER 400A  
BALLCOCK

## INTERIOR PLUMBING

### FLUSH VALVE



50407 MANSFIELD WATER SAVER  
FLUSH VALVE (SHOWN)  
10 3/4"H FOR ANY  
TOILET TANK - 50/CTN  
50191093 MANSFIELD TANK LEVER  
#123-8867

### FLUSH VALVE



502634 FLUSH VALVE 10 3/4"H  
WITH BALL & CHAIN

### TOILET BOLT SET

CLOSE COUPLED SOLID BRASS



50402 5/16" x 3"

### TOILET HOLD DOWN FASTENERS

W/ NUTS & WASHERS  
BRASS PLATED  
2 PER PACKAGE



502740 FASTENERS W/NUTS  
1/4" x 2 1/4"

### BALLCOCK FLOAT ROD



50405 BRASS 8" - 25/CTN

### STANDARD TANK LEVER

CHROME LEVER



50406 8" METAL ARM, PLASTIC SPUD

### STANDARD TANK LEVER

PLASTIC LEVER



508667 FLUIDMASTER TANK LEVER

### BOWL GASKET KIT

W/ GASKET, BOLTS, WASHERS, NUTS,  
WING-NUTS



50275 BOWL GASKET KIT

### ONE PC. RUBBER FLAPPER



50403 TANK BALL W/CHAIN & HOOK

## INTERIOR PLUMBING

### TOILET TANK FLOAT BALL



50404 BLACK PLASTIC 4" x 5"

### CLAMPS HOSE



505212 CLAMP HOSE 1/2" 1 1/4"  
5034112 CLAMPS 3/4" TO 1 1/2"



MANUFACTURED HOUSING

# INTERIOR PLUMBING

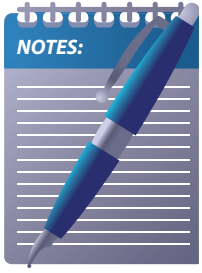

Four horizontal lines for notes, alternating between light blue and light green backgrounds.

Twenty horizontal lines for notes, alternating between light blue and light green backgrounds.



# PHOENIX<sup>®</sup>

FAUCETS

*For all your plumbing needs!*



[www.valterra.com](http://www.valterra.com)



# Phoenix<sup>®</sup> Catalina Faucets Designed for Manufactured Homes



## KITCHEN FAUCET W/O SPRAY 8" CENTER

PLASTIC UNDERBODY



53R5003 KITCHEN FAUCET W/O SPRAY 8" CENTER, CHROME

## KITCHEN FAUCET WITH SPRAY 8" CENTER

PLASTIC UNDERBODY



53R15003 KITCHEN FAUCET WITH SPRAY 8" CENTER, CHROME

## LAVATORY FAUCET LESS POP-UP 4" CENTER

PLASTIC UNDERBODY



53R4003 LAVATORY FAUCET LESS POP-UP 4" CENTER, CHROME

## GARDEN TUB FAUCET ADJUSTABLE CENTER

PLASTIC UNDERBODY



53R38 GARDEN TUB FAUCET ADJUSTABLE CENTERS, CHROME

## TUB/SHOWER FAUCET, DIVERter 8" CENTER

PLASTIC UNDERBODY



53R801 TUB/SHOWER FAUCET, DIVERter 8" CENTER



MANUFACTURED HOUSING



**INTERIOR PLUMBING**

**KITCHEN 8"**  
NM STEM/BONNET & UNDERBODY



53190007 KITCHEN 8" W/O SPRAY

**KITCHEN 8" SINGLE LEVER**  
HYBRID



53190008 KITCHEN 8" SL WITH SPRAY

**KITCHEN 8" SINGLE LEVER**  
HYBRID



53190009 KITCHEN 8" SL W/O SPRAY

**KITCHEN 8" HIGH RISE**  
HYBRID



53190005 KITCHEN 8" W/O SPRAY

**KITCHEN 8" HIGH RISE**  
HYBRID



53190006 KITCHEN 8" WITH SPRAY

**8" DECK FAUCET**  
CHROME W/CELCON UNDERBODY



532012 8" D-SPOUT, CLEAR  
HANDLES AND AERATOR

**HIGH RISE KITCHEN**  
BRUSHED NICKEL, W/CELCON BODY



532038 HIGH RISE KITCHEN 8"

**4" BAR FAUCET**  
CHROME W/CELCON UNDERBODY



532010 CLEAR HANDLES  
8" GOOSE NECK SPOUT

**3 3/8" TUB SHOWER**  
BRASS STEM BONNET & UNDERBODY



5363712 LONG SPOUT-RISER  
OUTLET FOR EXPOSED SHOWER

**INTERIOR PLUMBING**

**3 3/8" TUB SHOWER**

BRASS STEM BONNET & UNDERBODY



5363812 LONG SPOUT FOR CONCEALED SHOWER

**4" TUB SHOWER**

BRASS STEM/BONNET / PLASTIC UNDERBODY



531402 4" SHOWER ONLY CONCEALED RISER

**4" TUB SHOWER**

BRASS STEM BONNET & UNDERBODY



5364712 LONG SPOUT-RISER OUTLET FOR EXPOSED SHOWER

**4" TUB SHOWER**

BRASS STEM BONNET & UNDERBODY



5364812 LONG SPOUT FOR CONCEALED SHOWER

**8" TUB SHOWER**

BRASS STEM BONNET W/CELCON UNDERBODY



536801 TUB & SHOWER HEAD ARM & FLANGE 2" SHANKS  
536881 SHOWER ONLY W/ ARM & FLANGE 2" SHANKS

**8" 3-VALVE TUB SHOWER**

BRASS STEM BONNET & UNDERBODY



536603 FOR 7/8" MAX. WALL THICKNESS, ABS SHOWER HEAD, METAL ARM FLANGE

**8" 2-VALVE TUB SHOWER**

BRASS STEM BONNET & UNDERBODY



536703 FOR 7/8" MAX. WALL THICKNESS, ABS SHOWER HEAD, METAL ARM FLANGE

**GARDEN TUB**

BRASS STEM BONNET & UNDERBODY



53638 ADJUSTABLE TO 24" CENTERS, ACRYLIC HANDLES

**8" DECK, TUB/SHOWER FAUCET**

CHROME W/CELCON UNDERBODY



Note: Center hole offset inlet to spout connector



532013 CLEAR HANDLES, SHOWER HEAD, ARM & FLANGE

## INTERIOR PLUMBING

### 4" CENTER LAVATORY FAUCET

CHROME W/CELCON UNDERBODY



- 532011 CLEAR HANDLES, DRILLED LESS POP-UP ASSEMBLY
- 532011 CLEAR HANDLES, DRILLED LESS POP-UP ASSEMBLY

### 8" SHOWER VALVE

CHROME W/CELCON UNDERBODY



- 53204 SMOKE COLORED HANDLES, SHOWER HEAD, ARM & FLANGE

### LAVATORY FAUCET

BRUSHED NICKEL, W/CELCON BODY



- 532077 LAVATORY FAUCET 4"

### 4" LAVATORY

HYBRID W/O POP UP



- 53190001 LAVATORY 4" W/O POP UP

### 4" CENTER LAVATORY SL

HYBRID



- 53190003 LAVATORY SL WITH POP UP
- 53190010 LAV 4" SL W/O POP UP

### 4" LAVATORY NM

NM STEM/BONNET & UNDERBODY



- 53190004 LAVATORY 4" NM STEM

### KITCHEN FAUCET SPOUT

NO AERATOR



- 536012 8" PLASTIC, CHROME FINISH

### KITCHEN SPRAYER



- 536010 METAL SPRAYER AND HOSE

### UTOPIA® REPLACEMENT STEM & BONNET



- 5339004 FOR 1995 & NEWER FAUCETS 2/CARD

## INTERIOR PLUMBING

### SHOWER HEAD

ABS



- 5392438 3/8" ABS SHOWER HEAD WITH C.P. RING
- 5393412 1/2" ABS SHOWER HEAD WITH C.P. RING

### CENTER DIVERTER STEM



536040 CENTER DIVERTER STEM

### TUB SPOUT

W/ POP-UP



53185 TUB SPOUT - 50/CTN

### TUB SPOUT



536015 FOR 3 VALVE; DIVERTER  
8" CENTER. 50/CTN

### ARROW FAUCET HANDLE

CLEAR



536049 ARROW FAUCET HANDLE CLEAR

### HANDLES



5340916H HOT - CLEAR ACRYLIC  
5340916C COLD - CLEAR ACRYLIC

### RENU SEAT



536381

536601

536401

- 536381 RENU SEAT-GARDEN TUB #53638
- 536401 FOR ALL EXPOSED FITTINGS
- 536601 FOR ALL CONCEALED FITTINGS

### STEM & BONNET ASSEMBLY

COMPRESSION TYPE



**A**

**B**

- 5364050 EXPOSED FITTING WITH ACRYLIC HANDLES (A)
- 5366050 CONCEALED FITTINGS (B)

### FLANGE



536016 8" CENTER FLANGE

## INTERIOR PLUMBING

### HANDLES



53359H HOT - METAL LEVER  
53359C COLD - METAL LEVER

### GARDEN TUB FAUCET PARTS

FOR FAUCET 53638



5333970 SPOUT GARDEN TUB  
1/2" INLET  
53638916HC HANDLE HOT & COLD

### SHOWER ARM & FLANGE

ABS - PLATED



ITEMS SOLD SEPARATELY

530258 1/2" SHORT ARM  
536014 FLANGE

### SHOWER ARM & FLANGE KIT

ABS - PLATED KIT



53960108 1/2" SHOWER ARM  
W/ THREADED FLANGE KIT

### POP UP ASSEMBLIES

CHROME



536029 POP UP W/O OVERFLOW

### FAUCET REPAIR KIT

(FITS MOST BRANDS)



5360299 162 PIECE KIT



MANUFACTURED HOUSING



# INTERIOR PLUMBING



A Watts Water Technologies Company

The **Sea Tech 35 Series** products are designed and manufactured to be trouble free for many years of service. All 35 Series products are approved and certified to NSF-61, NSF-14, CSA B 137.5, ASTM F877 and the uniformed Plumbing Code. These fittings work interchangeably with copper, CPVC, polybutyl and PEX tubing.

### FITTING PERFORMANCE RATING

Operating Pressure: Vacuum to 250psi  
Max Temperature 180° @ 100psi / 75° @ 250psi

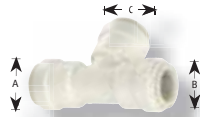

Not All Products are Illustrated! ~ Additional Products are Available!

## COLLET CLIPS

**NOTE: RECOMMENDED FOR USE WITH ALL FITTINGS**



- 50354708 3/8" COLLET CLIP
- 50354710 1/2" COLLET CLIP
- 50354714 3/4" COLLET CLIP

## 1/2" DROP EAR ELBOW



- 5035211008 1/2" DROP EAR ELBOW

## UNION TEES

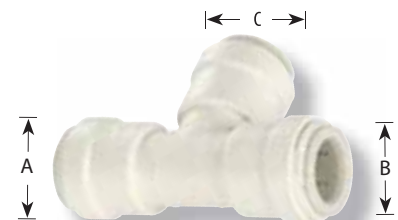

- 50352308 3/8" UNION TEE
- 50352310 1/2" UNION TEE
- 50352314 3/4" UNION TEE

## STOP VALVES



- 50353908 3/8" STOP VALVE
- 50353910 1/2" STOP VALVE
- 50353914 3/4" STOP VALVE

## UNION CONNECTORS



- 50351508 3/8" UNION CONNECTOR
- 50351510 1/2" UNION CONNECTOR
- 50351514 3/4" UNION CONNECTOR

## 1/2" UNION CHECK VALVE



- 50354010 1/2" UNION CHECK VALVE

## STACKABLE ELBOWS



- 50351810 1/2" STACKABLE ELBOW

## 90° ELBOWS



- 50351710 1/2" 90° ELBOW
- 50351714 3/4" 90° ELBOW

## 1/2" FEMALE SWIVEL ELBOWS



- 5035200808 3/8" FEMALE SWIVEL ELBOW
- 5035201008 1/2" FEMALE SWIVEL ELBOW

## INTERIOR PLUMBING

### STACKABLE TEES



50353310 1/2" STACKABLE TEE  
50353314 3/4" STACKABLE TEE

### MALE CONNECTORS



5035011008 1/2" MALE  
5035011014 1/2" x 3/4" MALE  
5035011412 3/4" MALE

### FEMALE CONNECTORS



5035100808 3/8" FEMALE  
5035101008 1/2" FEMALE  
5035101412 3/4" FEMALE  
5035101013 1/2" CLOSET

### 1/2" MALE ELBOW



5035191008 1/2" MALE ELBOW

### 3/4" X 1/2" REDUCING STEM



5035141410 3/4" X 1/2" REDUCING STEM

### 1/2" END STOP



50354510 1/2" END STOP

### REDUCING UNIONS



5035013516 1/2" x 3/8"  
5035151410 1/2" x 3/4"  
5035161004 1/2" x 1/4"

### REDUCING TEES



5035241410 3/4" x 1/2" REDUCING TEE  
5035241004 1/2" x 1/4" REDUCING TEE



**MANUFACTURED HOUSING**





## HOW TO USE FLAIR-IT FITTINGS

### FLARED - CONE & NUT FITTINGS

- Designed for normal hot & cold potable water • Reusable fittings - No corrosion or scaling
- Simple installation - No crimping tools, cements, solder or teflon tape needed
- Complies with ASTM D 3309 & NSF listed (standard 14) • For Manufactured Housing & Rec. Vehicles

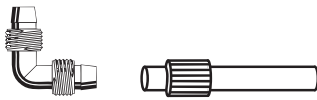
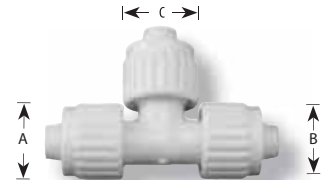

**STEP 1**  
Slide nut over tubing.

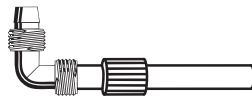

**STEP 2**  
Firmly press tubing onto the flare of the fitting until the tubing rests against the fittings threads.

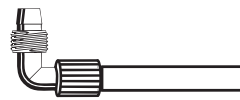

**STEP 3**  
Slide the nut to the threads and tighten securely onto the fitting.

### ADAPTER - PEX FITTING



5006792 3/4" x 3/4" ADAPTER  
PEX FITTING-10 BAG

### SWIVEL ELBOWS

FAUCET TO FLAIR-IT



5006816 1/2" x 1/2" F SWIVEL POLY  
PEX 10/BAG  
5006807 3/4" x 3/4" F SWIVEL PEX  
ONLY 10/BAG  
5006817 3/8" x 1/2" F SWIVEL  
POLY / PEX 10 BAG

### DROP EAR ELBOW

SHOWER/TUB TO FLAIR-IT



5006801 1/2" x 1/2" POLY / PEX 10 BAG

**ADAPTERS - FEMALE**



- 5006841 1/2" x 1/2" F POLY / PEX 10 BAG
- 5006847 3/4" x 3/4" F PEX ONLY 10 BAG
- 5006858 1/2" x 3/4" F PEX ONLY 10 BAG

**ADAPTERS - MALE**



- 5006842 1/2" x 1/2" M POLY / PEX 10 BAG
- 5006848 3/4" x 3/4" M PEX ONLY 10 BAG

**MALE ELBOWS**



- 5006803 1/2" x 1/2" POLY / PEX 10 BAG
- 5006810 1/2" x 3/8" POLY / PEX 10 BAG

**ICE MAKER TEE & VALVE**

FOR 1/2" PEX



- 5005834 ICE MAKER TEE W/VALVE

**ELBOWS**

WITH 2 FLAIR-IT CONNECTIONS



- 5006800 1/2" P x 1/2" P POLY / PEX 10 BAG
- 5006806 3/4" P x 3/4" P PEX ONLY 10 BAG
- 5006815 3/8" P x 3/8" P POLY / PEX 10 BAG

**ELBOWS**

W/FEMALE PIPE THREAD AND FLAIR-IT CONNECTIONS



- 5006813 3/4" P x 3/4" FPT PEX ONLY 10 BAG

## INTERIOR PLUMBING

### CAPS



- 5006860 1/2" PIPE CAP POLY/PEX10BAG  
5006861 3/4" PIPE CAP POLY/PEX 10BAG

### SWIVEL STRAIGHT COUPLINGS

FAUCET TO FLAIR-IT CONNECTION



- 5006873 1/2" P x 1/2" FPT POLY / PEX10 BAG  
5006874 3/8" P x 1/2" FPT POLY / PEX10 BAG  
5006849 3/4" P x 3/4" FPT PEX ONLY 10 BAG  
5006856 1/2" P x 3/4" FPT PEX ONLY 10 BAG

### BALLCOCK ADAPTERS

TOILET TO FLAIR-IT CONNECTION



- A X B  
5006865 1/2" x 3/4" F PEX ONLY 10 BAG  
5006869 3/8" x 3/4" F PEX ONLY 10 BAG

### STRAIGHT STOP VALVES

IN-LINE VALVE



- 5006879 3/8" P STRAIGHT VALVE  
POLY / PEX  
5006880 1/2" P STRAIGHT VALVE  
POLY / PEX

### COUPLINGS



- 5006855 3/8" P x 3/8" POLY / PEX 10 BAG  
5006840 1/2" P x 1/2" POLY / PEX10 BAG  
5006846 3/4" P x 3/4" PEX ONLY10 BAG  
5006853 1/2" P x 3/8" POLY / PEX10 BAG  
5006845 1/2" x 3/4" P PEX ONLY10 BAG

### PLUGS

INSERTION INTO PIPE END



- 5006863 1/2" PEX ONLY 10 BAG  
5006864 3/4" PEX / FLAIR 10 BAG



## INTERIOR PLUMBING

### TUFF-PEX TUBING

CROSS LINKED POLYETHYLENE



- 50100001 1/2" x 100' BLUE
- 50100002 1/2" x 100' RED
- 50100003 3/4" x 100' BLUE
- 50100004 3/4" x 100' RED

### TUFF-PEX TUBING

CROSS LINKED POLYETHYLENE



- 5012020 1/2" x 20' (1/2"ID-5/8"OD)
- 5012100 1/2" x 100' (1/2"ID-5/8"OD)
- 5038100 3/8" x 100' (3/8"ID-1/2"OD)
- 5034020 3/4" x 20' (3/4"ID-7/8"OD)
- 5034100 3/4" x 100' (3/4"ID-7/8"OD)

### PEX STOP VALVES



- 504947 1/2" PEX STOP VALVE

### SWIVEL ELBOWS



- 504433 1/2" PEX SWIVEL ELBOW
- 504449 3/4" PEX SWIVEL ELBOW"

### FAUCET CONNECTION

1/2" X 1/2"



- 504933 1/2" x 1/2" FAUCET CONNECTION

### ELBOWS

BARB X BARB / BRASS



- 5074425 ELBOW 1/2" x 1/2" 25 BAG
- 5076425 ELBOW 3/4" x 1/2" 25 BAG
- 5076625 ELBOW 3/4" x 3/4" 25 BAG

### MALE PIPE ADAPTERS

BRASS INSERT FITTING FOR PEX TUBING

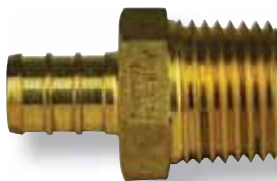

- 50104425 BRASS 1/2" PEX x 1/2" MP
- 50104625 BRASS 1/2" PEX x 3/4" MP
- 50106425 BRASS 3/4" PEX x 1/2" MP
- 50106625 BRASS 3/4" PEX x 3/4" MP

### FEMALE PIPE ADAPTERS

BRASS INSERT FITTING FOR PEX TUBING

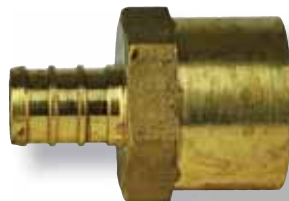

- 5094425 BRASS 1/2" PEX x 1/2" FP
- 5096625 BRASS 3/4" PEX x 3/4" FP

### FEMALE PIPE ADAPTER

BRASS INSERT FITTING FOR PEX TUBING  
THREE PIECE SWIVEL



- 50246625 BRASS 3/4" PEX x 3/4" SFP

## INTERIOR PLUMBING

### TEES

BARB X BARB X BARB / BRASS

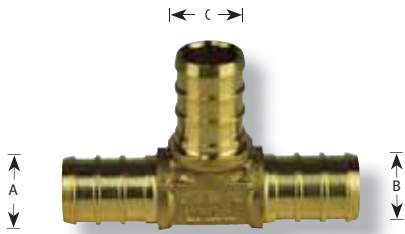

- 50644425 TEE 1/2" x 1/2" x 1/2" 25 BAG
- 50664612 TEE 3/4" x 1/2" x 3/4" 12 BAG
- 50666425 TEE 3/4" x 3/4" x 1/2" 25 BAG
- 50666625 TEE 3/4" x 3/4" x 3/4" 25 BAG

### COPPER CRIMP RINGS

BLACK - HARDENED / COPPER



- 50254100 1/2" TUBING RING 100 BAG
- 50256100 3/4" TUBING RING 100 BAG

### 1/2" BALLCOCK SWIVEL

3 PIECE



- 506475 1/2" BALLCOCK SWIVEL 3 PIECE

### COUPLINGS

BARB X BARB / BRASS



- 5014425 COUPLER 1/2" x 1/2" 25 BAG
- 5016625 COUPLER 3/4" x 3/4" 25 BAG

### ADAPTER COUPLINGS

PEX BARB X PB BARB / BRASS



- 50184425 ADAPTER 1/2" x 1/2" 25 BAG
- 50186625 ADAPTER 3/4" x 3/4" 25 BAG

### CRIMP TOOL

NON RATCHETING  
SHORT HANDLE TOOLS 12"



- 6212 CRIMP TOOL, 1/2" TUBING
- 6234 CRIMP TOOL, 3/4" TUBING

### UNIVERSAL TUBING CUTTER



- 62125 FOR 3/8"-3/4" TUBING



MANUFACTURED HOUSING



## ACETAL FITTINGS

- Standard Pipe Thread
- Compression Fittings
- Use with Copper, CPVC,
- Galvanized & Polybutylene

### NUT/RING/CONE SETS



- 501001 FOR 1/4" NOMINAL TUBE
- 501002 1/2" THREAD FOR 3/8" NOMINAL TUBE SIZE
- 501003 3/4" THREAD FOR 1/2" NOMINAL
- 501004 1" THREAD FOR 3/4"

### TEES

ALL MPT

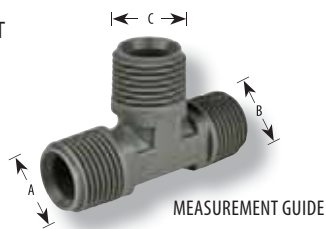

- 501024 1/2" MPT
- 501025 3/4" x 1/2" x 3/4" MPT
- 501026 3/4" MPT
- 501027 1" x 3/4" x 3/4" MPT
- 501028 1" x 1" x 3/4" MPT
- 501029 1" MPT

### ELBOWS

ALL MPT



- 501019 1/2" MPT
- 506432 1/2" x 3/8" MPT – DISHWASHER
- 506443 1/2" x 3/4" MPT
- 501020 3/4" MPT
- 501021 1" x 3/4" MPT
- 501022 1" MPT

## INTERIOR PLUMBING

### FEMALE ELBOW

DROP EAR



501018 3/4" MPT x 1/2" FPT

### STREET ELBOW



501023 1/2" MPT x 1/2" FPT

### ADAPTERS

MALE/FEMALE



501012 3/4" MPT x 1/2" FPT

501015 1" MPT x 3/4" FPT

### COUPLINGS/NIPPLES



501010 1/2" MPT

501011 3/4" MPT x 1/2" MPT

501013 3/4" MPT

501014 1" MPT x 3/4" MPT

501016 1" MPT

### IN-LINE GLOBE SHUT OFF VALVES



501100 1/2" MPT x 1/2" MPT

501101 3/4" MPT x 3/4" MPT

### STOP VALVES



506441 1/2" MPT x 1/2" MPT

506442 3/4" MPT x 1/2" MPT



**6-IN-1 DRIVER**

1/4" & 5/16" HEX OPENING NUT DRIVER WITH 3/16" & 9/32" SLOTTED HEAD BIT AND #1 & #2 PHILLIPS HEAD BIT

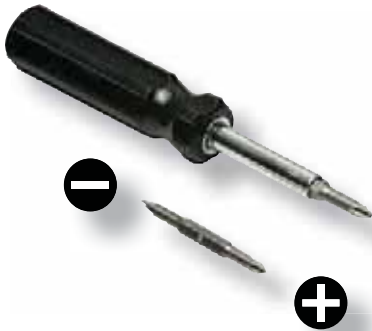

62816 6 IN 1 SCREW/NUT DRIVER

**NUT SETTERS**

LONG



62823 5/16" NUT SETTER LONG  
62824 1/4" NUT SETTER LONG

**1/4" MAGNETIC BIT HOLDER**

FOR ANY STYLE INSERT BIT



62802 BODY DIAMETER 7/16" STAINLESS STEEL

**POWER BITS**

1/4" HEX SHANK



62807 5/32" CLUTCH  
62810 #2 PHILLIPS  
62814 #2 SQUARE RECESS

**STOVE BOLTS**

20 ROUND HEAD



651434 1/4" x 3/4" W/NUT 100/BOX

**1 1/2" WHITE ROSETTE #6 SCREWS**



65112 WHITE ROSETTE SCREWS 1 1/2" 100 BAG

**WHITE ROSETTES**

1" DIAMETER



65251 1" ROSETTES 25/BAG

**UNIVERSAL TUBING CUTTER**



62125 FOR 3/8" - 3/4" TUBING

**SNAP LOCK PUNCH**

FOR VINYL ONLY



623764 1/2" THROAT DEPTH 8 1/2" LONG 3 CTN

**POCKET PENETROMETER AND ADAPTER FOOT**



62700 POCKET PENETROMETER  
W/CANVAS CASE  
62701 ADAPTER FOOT

**FAIL-SAFE CRIMP TOOL**  
FOR PEX TUBING



6212 1/2" CRIMP TOOL  
6234 3/4" CRIMP TOOL

**STRAP CRIMP TOOL**  
FOR ANCHOR STRAPS



621125 STRAP CRIMP TOOL  
FOR 1 1/4" STRAP

**ANCHOR SPEED WRENCH**



6248900 ANCHOR SPEED WRENCH

**3 POSITION UTILITY KNIFE**  
SIDE BUTTON



623340 WITH 3 BLADES - 18 CTN  
623145 DOUBLEPOINTBLADES,  
5 PKG 10/CTN

**COLORLED PANEL NAILS**

1" NAILS OR 1 5/8" NAILS  
6 OZ. PACKAGE



655861 1" WHITE  
656261 1 5/8" WHITE  
  
655897 1" MEDIUM BROWN  
656297 1 5/8" MEDIUM BROWN  
  
655817 1" DARK BROWN  
656217 1 5/8" DARK BROWN

**LAG SCREWS & WASHERS**

5/8" HEX HEAD, ZINC & NO ZINC PLATED



653850 3/8" FLAT WASHER ZINC 50/BOX  
653852 1/2" FLAT WASHER ZINC 50/BOX  
653851 3/8" x 5" SCREW NO ZINC 300BOX  
6538450 3/8" x 4" SCREW ZINC 50/BOX  
6538550 3/8" x 5" SCREW ZINC 50/BOX  
6538650 3/8" x 6" SCREW ZINC 50/BOX

**ZINC PLATED 1/4" HEX HEAD SCREWS**

500 PER BOX



6587520 #8 x 3/4" 500/BOX  
658120 #8 x 1" 500/BOX  
6581520 #8 x 1 1/2" 500/BOX  
6582001 #8 x 2" 500/BOX

**TARP STRAP**

RUBBER W/ METAL "S" HOOKS



6215 15" LENGTH / RUBBER  
6221 20" LENGTH / RUBBER  
6231 31" LENGTH / RUBBER

### PAINTED 1/4" HEX HEAD SCREWS

500 PER BOX



- 6581750 #8 x 3/4" WHITE 500/BOX
- 6581201 #8 x 1" WHITE 500/BOX
- 65812591 #8 x 1 1/4" WHITE 500/BOX
- 6581501 #8 x 1 1/2" WHITE 500/BOX

### ZINC PLATED & WHITE PAINTED 1/4" HEX HEAD SCREWS



#### ZINC COATED

- 65875100 #8 x 3/4" ZINC 100/BOX
- 6581100 #8 x 1" ZINC 100/BOX
- 65815100 #8 x 1 1/2" ZINC 100/BOX

#### WHITE

- 6581101 #8 x 1" WHITE 100/BOX
- 65815101 #8 x 1 1/2" WHITE 100/BOX

### SHOCK CORDS

W/LOCKING METAL SNAPS

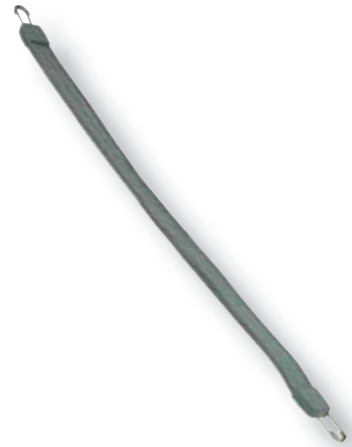

6051622 18" LENGTH 25/CTN

### ANCHOR DRIVE MACHINE

HEAVY DUTY 17.25 RPM

1/2 HP DRIVE MACHINE

120V / 60 CYCLE / 9 AMP

MOTOR "ON / OFF" SWITCH W/ FORWARD & REVERSE

DRIVE HEAD SOLD SEPARATELY (#482741)



- 482741 DRIVE HEAD ADAPTER
- 4859226 1/2 HP DRIVE MACHINE

### SOIL TEST PROBE

DETERMINES SOIL TYPE FOR PROPER

ANCHOR SELECTION



4859200 SOIL TEST PROBE W/CARRYING CASE & TORQUE WRENCH INSTRUCTION

**ANTI-FREEZE HAND PUMP**

PUMPS ANTIFREEZE DIRECTLY INTO WATER LINES AND SUPPLY TANKS



- 44501 BLOWOUT PLUG – PLASTIC
- 44503 ANTIFREEZE HAND PUMP

**HYDRAULIC BOTTLE JACK**



- 6276512 12 TON, LIFT: 6 1/16" 10 7/16" 4/CTN
- 6276412 12 TON, LIFT: 9 7/16" 15 5/16" 4/CTN
- 612100 REPAIR PARTS FOR 12 TON JACK

**HYDRAULIC BOTTLE JACK**



- 6276520 20 TON, LIFT: 10 3/16" - 7 7/16"
- 621253 REPAIR PARTS FOR 20 TON JACK

**TOILET BOLT SET**

CLOSE COUPLED SOLID BRASS



- 50402 5/16" x 3" 300/CTN

**TOILET HOLD DOWN FASTENERS**

W/ NUTS & WASHERS  
BRASS PLATED  
2 PER PACKAGE



- 502740 FASTENERS W/NUTS 1/4" x 2 1/4"

**CAULKING GUN**



- 6277 FOR ALL STANDARD SIZE CAULK 24/CTN



**MANUFACTURED HOUSING**

## KOOL SEAL PREMIUM ELASTOMERIC FINISH COAT 10 YEAR



- Renews most roofing substrates
- Expands and contracts with the roof
- Long lasting protection and reflectivity



426821 .9 GAL. ROOF COATING  
426655 4.75 GAL. ROOF COATING

## KOOL SEAL ELASTOMERIC FINISH COAT 5 YEAR



- Economy grade
- Reflects heat and harmful UV rays



426625 4.75 GAL.

## KOOL SEAL PREMIUM FIBERED ALUMINUM ROOF COATING 5 YEAR



- Renews most roofing substrates
- Expands and contracts with the roof
- Long lasting protection and reflectivity



426841 .9 GAL. PREMIUM  
426645 4.75 GAL. PREMIUM

**KOOL SEAL FIBERED ALUMINUM ROOF COATING 3 YEAR**

- Economy grade
- Reinforced with fiber for durability
- Reflects heat and harmful UV rays
- Protects against the elements, extending the life of the roof



426871 .9 GAL.

426675 4.75 GAL.

**KOOL SEAL ACRYLIC PATCHING CEMENT**

- Blend of acrylic resin and reinforcing material designed to stop leaks in damp or dry surfaces
- Seals out water and resists mildew and weathering when cured



436121 .9 GAL. ROOF SEAL/PATCH CEMENT

**WET OR DRY PLASTIC ROOF CEMENT**

- A blend of selected asbestos
- Smooth, easy-working consistency which adheres to wet or dry surfaces
- Flexible after application, expanding and contracting on the surface to which it is applied
- High resistance to weathering
- Provides excellent durability against all the stresses and wear to which such products are normally exposed



431651128 CEMENT ROOF COAT .9 GAL.

### ALL PURPOSE CAULK

- SILICONIZED ACRYLIC LATEX
- WHITE
- MILDEW RESISTANT
- WATER CLEAN UP
- INDOOR / OUTDOOR
- MEETS ASTM C-834
- NONFLAMMABLE



43306 ALL PURPOSE CAULK 6 OZ.

### ACRYLIC CAULK

- WHITE
- 15 YEAR WARRANTY
- PAINTABLE
- NON-STAINING
- WATER CLEAN UP
- INDOOR / OUTDOOR



43169402 WHITE ACRYLIC CAULK 10.2 OZ.

### BUTYL GUTTER SEAL CAULK / WHITE

- DESIGNED FOR SEALING
- ALUMINUM GUTTERS
- VINYL GUTTERS
- DOWN SPOUTS
- METAL FLASHING
- TRIM PLATES AND
- EXTERIOR BUILDING MATERIALS



43169702 WHITE BUTYL SEAL CAULK 10.3 OZ.

### SILICONE SEALANTS / CLEAR OR WHITE

IDEAL FOR SEALING AROUND:

- PANELS
- WINDOWS
- DOORS
- SKYLIGHTS
- ALUMINUM SIDING
- INTERIOR / EXTERIOR BUILDING MATERIALS



43169300 CLEAR CAULK 10.2 OZ.

43169302 WHITE CAULK 10.2 OZ.

### WET/DRY PLASTIC ROOF CEMENT

FORMS AN ELASTIC, DURABLE AND WATER RESISTANT SEAL PROVIDES MAXIMUM RESISTANCE TO WEATHERING

USES:

- ASPHALT ROOFS
- METAL ROOFS
- COMPOSITION ROOFS
- AROUND CHIMNEYS
- DOWN SPOUTS
- EAVES



431651011 WET / DRY SURFACE CEMENT 11 OZ.

### ALL PURPOSE CONSTRUCTION ADHESIVE

- FOR GENERAL CONSTRUCTION, REMODELING, MAINTENANCE & REPAIR PROJECTS
- HIGH STRENGTH PERMANENT BOND
- HEAT AND WATER RESISTANT
- QUICK-GRAB FORMULA



436024 ALL PURPOSE CONSTRUCTION ADHESIVE

436030 ALL PURPOSE CONSTRUCTION ADHESIVE  
LOW VOC (OHIO ONLY)

### SUBFLOOR & CONSTRUCTION ADHESIVE

MEETS ASTM-C-557, ASTM-D-3498, APA-AFG-01

- EXTERIOR GRADE
- WEATHER PROOF AND PERMANENT
- ELIMINATES SQUEAKS
- BEST FOR:
- PERMANENT WOOD FOUNDATIONS
- PLYWOOD SUBFLOORS
- DECKS
- SIDING
- FENCING



431017 SUBFLOOR & CONSTRUCTION ADHESIVE - 10.5 OZ. 12/BOX



MANUFACTURED HOUSING

### BUTYL TAPES

BLACK / GRAY • FOR HORIZONTAL APPLICATIONS ON SKYLIGHTS

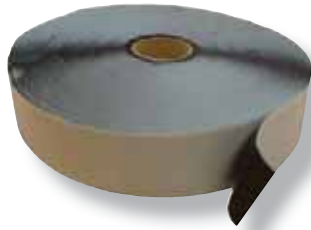

- 6011218 BLACK BUTYL TAPE 1/8" x 1 1/2" x 30'
- 603418 BLACK BUTYL TAPE 1/8" x 3/4" x 30'
- 60183430 GRAY BUTYL TAPE 1/8" x 3/4" x 30'

### TEFLON THREAD SEAL TAPES

FOR METAL, PLASTIC OR RUBBER PIPE THREADS



- 601226 1/2" x 260"
- 603426 3/4" x 260"

### INSULATION & HVAC TAPE ALUMINUM FOILS



- 602000 FOIL TAPE UL181 2" x 60 YDS. 24/CASE
- 602857B BLACK CLOTH DUCT TAPE UL181 2" x 60 YDS. 24 CASE
- 602857S SILVER CLOTH DUCT TAPE UL181 2" x 60 YDS. 24 CASE
- 602509 ALUMINUM FOIL TAPE 2" x 50 YDS. 24 CTN

### PEEL N' SEAL

THE BETTER WAY TO FINISH LOW SLOPE ROOFS AND MAKE QUICK WATER-PROOF REPAIRS. SELF - STICK ALUMINUM ROLL ROOFING



- 43334 SILVER 4" x 33.5'
- 43336 SILVER 6" x 33.5'
- 433312 SILVER 12" x 33.5'
- 433336 SILVER 36" x 33.5'

### PUTTY TAPES

COLORMETRIC • FOR VERTICAL APPLICATIONS ON DOORS AND WINDOWS



- 43120334 1/8" x 3/4" x 30' 24 CTN.
- 43120410 1/8" x 1" x 30' 16 CTN.
- 43120615 1/8" x 1 1/2" x 30' 12 CTN.

### BOTTOM CLOSURE TAPES

MENDING MATERIAL  
SOLID COATED FABRIC W/ADHESIVE



- 60600 TAPE 6" x 180' TO REPAIR LONG SLITS AROUND AC OR WATER LINES 12/CTN.
- 602825 ROLL 28" x 25' FOR ANY SIZE PATCH 20 CTN.

### ELECTRICAL TAPE



- 603420 BLACK 3/4" x 20 YDS.

### FLEX-MEND



- 60400 FLEX-MEND 4" x 180' ROLL



**CLOTH DUCT TAPES**

GENERAL PURPOSE  
HVAC & DUCT APPLICATIONS



- 602609 BLACK 2" x 60 YDS. 24 CTN.
- 602603 SILVER 2" x 60 YDS. 24 CTN.

**BOTTOM BOARD TAPE**

HIGH TACK • BOTTOM BOARD USE • BLACK



- 60620 BOTTOM BOARD TAPE BLACK 2" x 36 YDS.

**SPRAY ADHESIVE**

MULTI-PURPOSE FOR BOTTOM BOARD,  
LINOLEUM, CARPET, ETC



- 433824 16 OUNCE CAN

**WD-40 LUBRICANT**

PREVENTS RUST - FREES CABLES  
STOPS SQUEAKS • LUBRICATES LOCKS,  
TOOLS, SLIDING WINDOWS, LAWN MOWERS,  
FISHING GEAR, BIKES, SEWING MACHINES,  
AND MORE!



- 604011 8 OUNCE SPRAY CAN 12/CTN.

**SPRAY ADHESIVE**

MULTI-PURPOSE FOR BOTTOM BOARD,  
LINOLEUM, CARPET, ETC.



- 43RCD52 16 OUNCE CAN

**CAULKING GUN**



- 6277 FOR ALL STANDARD SIZE CAULK 24/CTN.N.

**SQUEAK - ENDER**

SOLUTION TO SQUEAKY FLOORS



- 602084 INSTALL FROM UNDER SIDE OF FLOOR

**SAG - ENDER**

SOLUTION TO THOSE ANNOYING  
SUB-FLOOR SAGS, DIPS  
AND WEAK SPOTS

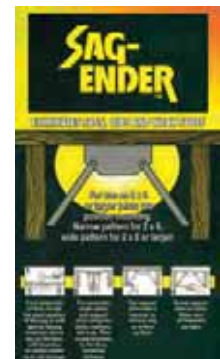

- 603827 SAG-ENDER FOR FLOORS.

### 3" CHIP BRUSH

W/ WOOD HANDLE



42143 3" CHIP BRUSH

### ROOF COAT BRUSHES & HANDLES

BRUSH AND HANDLE SOLD SEPARATELY



42972 WOODEN BRUSH 4 3/4" 84 CTN.

42989 WOODEN HANDLE 48" 50 BDL.

### SEALER FOAM



60155550 SEALER FOAM 5 1/2" x 50"

### BOTTOMBOARD REPAIR KITS



60101 BOTTOMBOARD 30" X 100' ROLL

601470 BOTTOMBOARD 172" X 70'

602881 KIT CONTENTS: 10 SQUARE FEET WITH ADHESIVE (54" X 28")  
20 SQUARE FEET NON ADHESIVE (108" X 28")  
POLYETHYLENE BOTTOMBOARD



**MANUFACTURED HOUSING**

# INDEX BY ALPHABET

## -A-

A.C. Disconnect Switch Non-fusible 60 Amp	E-55
ABS 22-½° Elbow 3" x 3"	I-5
ABS 45° Elbows 1 ½" x 1 ½"	I-5
ABS 45° Elbows 3" x 3"	I-5
ABS 45° Wye 3" x 3" x 3"	I-5
ABS 90° Elbows 1 ½" x 1 ½"	I-5
ABS 90° Elbows 1 ½" x 1 ½"	I-5
ABS 90° Elbows 3" x 3"	I-5
ABS 90° Elbows 3" x 3"	I-5
ABS Closet Flange 4" x 3" - FPT	I-6
ABS Closet Flange 4" x 3" - Hub	I-6
ABS Closet Flange 4" x 3" - MPT	I-6
ABS Couplings 1 ½" x 1 ½"	I-6
ABS Couplings 2" x 2"	I-6
ABS Couplings 3" x 3"	I-6
ABS Elbows 3" x 3" 45°	I-5
ABS Elbows 3" x 3" 90°	I-5
ABS Fitting Clean Out Adapters 1 ½" x 1 ½"	I-5
ABS Fitting Clean Out Adapters 2" x 2"	I-5
ABS Fitting Clean Out Adapters 3" x 3"	I-5
ABS Flush Bushing 2" x 1 ½"	I-6
ABS Foamcore Pipe 1 ½" x 10'	I-3
ABS Foamcore Pipe 2" x 10'	I-3
ABS Foamcore Pipe 3" x 10'	I-3
ABS Foamcore Pipe 3" x 20'	I-3
ABS Long-Turn Tee Wyes 1 ½" x 1 ½" x 1 ½"	I-5
ABS Long-Turn Tee Wyes 2" x 2" x 2"	I-5
ABS Long-Turn Tee Wyes 3" x 3" x 1 ½"	I-5
ABS Long-Turn Tee Wyes 3" x 3" x 3"	I-5
ABS Long-Turn Tee Wyes 3" x 3" x 2"	I-5
ABS P-Trap 1 ½" x 1 ½"	I-5
ABS P-Trap 1 ½" x 1 ½" x ¾"	I-5
ABS P-Trap Adapters 1 ½" x 1 ½"	I-6
ABS P-Trap Adapters 1 ½" x 1 ¼" W/Tube Stop & Sj Washers	I-6
ABS Pipe Cement ABS Black 1 Pint	I-9
ABS Pipe Cement ABS Black 1 Quart	I-9
ABS Pipe Cement ABS Black ½ Pint	I-9
ABS Pipe Cement ABS Black ¼ Pint	I-9
ABS Tees 1 ½" x 1 ½" x 1 ½"	I-5
ABS Tees 3" x 3" x 3"	I-5
ABS Threaded Plugs 1 ½"	I-6
ABS Threaded Plugs 3"	I-6
ABS Tray Plug 1 ½" SP x SPSM	I-5
Access Door 18" x 24" Flange Mount	B-12, B-17
Access Door 18" x 24" Track Mount	B-12, B-17
Accucharge®-A/C 14 SEER (TXV)	E-18
Acrylic Caulk 10.2 Oz. White	L-3
Adapter 1" MPT x ¾" FPT	J-40
Adapter ¾" MPT x ½" FPT	J-40
Adapter Coupling ½" x ½"	J-38
Adapter Coupling ¾" x ¾"	J-38
Adapter Foot	D-7, K-2
Adapter Pex Fitting ¾" x ¾"	J-33
Adapters - Female ½" x ½" F Poly / Pex	J-34
Adapters - Female ½" x ¾" F Pex Only	J-34
Adapters - Female ¾" x ¾" F Pex Only	J-34
Adapters - Male ½" x ½" M Poly / Pex	J-34
Adapters - Male ¾" x ¾" M Pex Only	J-34
Adjustable Outrigger Kit For 16' Wide (2 Pack)	D-9
Adjustable Outrigger Kit For 12' To 14' Wide (2 Pack)	D-9
Air Inlet Kit - Direct Vent - Basement/Crawl	J-6
Aluminum Foil Tape 2" x 50 Yds.	L-4
Aluminum Starter Strip	B-38
Anchor Drive Machine Drive Head Adapter	D-7, K-3
Anchor Drive Machine ½ HP Drive Machine	D-7, K-3

Anchor Speed Wrench	D-7, K-2
Anchors Single Disk 24" Long x ⅝" Rod W/6" - Galvanized	D-1
Anchors Single Disk 48" Long x ¾" Rod W/6" Helix - Galvanized	D-1
Anchors Single Disk 48" Long x ⅝" Rod W/6" Helix - Galvanized	D-1
Anti-Freeze For Full Strength Usage - 1 Gallon	I-1
Anti-Siphon Valve Connects To Any Hose Thread Break Off Bolt	I-3
Antifreeze Hand Pump	I-1, K-4

## -B-

Backflow Damper Automatic Cavity	E-45
Backflow Damper Gas/Oil Furnace	E-34, E-45, E-56
Backflow Damper Pkg. AC Gas/Oil Furnace	E-34, E-56
Backflow Preventer Stainless Steel Springs	I-3
Ball Valve ¾" FTP Brass	I-4
Ballcock Adapters ½" x ¾" F Pex Only	J-35
Ballcock Adapters ¾" x ¾" F Pex Only	J-35
Ballcock Float Rod Brass 8"	J-21
Ballcock Fluidmaster	J-20
Ballcock Swivel ½" 3 Piece	J-38
Ballcock W/ Water Level	J-20
Bathroom Ceiling Fan Assembly	F-9
Bathroom Ceiling Fan Blade For 59200	F-9
Bathroom Ceiling Fan Cover Lens For 59200	F-9
Bathroom Ceiling Fan Replacement Cover	F-9
Bathroom Ceiling Fan Replacement Motor	F-9
Bathroom Ceiling Fan Vertical Outlet, 10 ¾" R.O. Uses 7 ⅞" Diameter Duct	F-9
Bathroom Sink Tubular Tailpiece, 1 ¼" x 6"	J-19
Bathtub Drain 1 ½"	J-18
Batten	H-71
Bay Corner 3"	B-34
Beam Clamp W/ Bolt And Nut 3"	D-5
Beam Clamp w/ Bolt And Nut 4"	D-5
Bearing Cone Inner 2 7/8"	C-4
Bearing Cone Outer 2"	C-4
Black Cloth Duct Tape UI 181 2" x 60 Yards	L-4
Blocking Pier	D-4
Blower	E-27
Blowout Plug - Plastic	I-1, K-4
Board	D-8
Boiler Drain	I-4
Bottom Board Tape Black 2" x 36 Yards	L-5
Bottom Closure Tape 6" x 180'	L-4
Bottom Closure Tape Roll 28" x 25' For Any Size Patch	L-4
Bottom Track Brown 10'	B-16
Bottom Track Granite 10'	B-16
Bottom Track Sandstone 10'	B-16
Bottom-board 172" x 70'	L-6
Bottom-board 30" x 100' Roll	L-6
Bottom-board Repair Kit	L-6
Bowl Gasket Kit	J-21
Brace EZ Joist	D-9
Butyl Seal Caulk 10.3 Oz. White	L-3
Butyl Tape	L-4

## -C-

Casing	H-72
Caulk All Purpose 6 Oz.	L-3
Caulking Gun For All Standard Size Caulk	K-4, L-5
Ceiling Beam 10 Ft. White	H-72
Ceiling Fixture	F-1 thru F-5
Ceiling Rings (2 Piece Adjustable)	E-45
Cement 3-Way	I-9
Center Diverter Stem	J-28
Chain Stop-Anodized	H-61
Check Valve ¾"	I-2
Chip Brush 3"	L-6
Chrome C.O. Plug W/	J-18

## INDEX BY ALPHABET

Circuit Adapter	E-30, E-32	Dryer - Gas 6.5 Cubic Foot - White	G-4
Circuit Breaker Single Phase (2-Pole)	E-30, E-32	Dryer Cord 4'30 Amp	F-9, G-9
Clamp Gator Beam 8 Bolt	D-5	Dryer Unit Kit	G-10
Clamp Hose 3 5/8" To 4 1/2"	G-10	Dryer Vent Kit Flexible Alum. Duct - Rigid 8'	G-10
Cleaner All Purpose 1/4 PT	I-9	Dual Fuel Kit	E-28
Close-up Beam 12 Ft. White	H-72	Duct Collar	E-30, E-32, E-34
Cloth Duct Tape Black 2" x 60 Yards	L-5	Duct Connector W/ Damper (1 Required For Install)	E-33
Cloth Duct Tape Silver 2" x 60 Yards	L-5	Duplex Cover Plate-Double Deco-Snap On White	F-11
Coach Porch Fixture Brushed Nickel	F-7	Duplex Receptacle	F-11, F-12
Coil Cabinet (20")	E-45, E-47	-E-	
Coil Cabinet (26")	E-45, E-47	Eagle Skirting	B-11
Coil Cabinet 20"	E-50, E-52, E-53	Elbows	J-31, J-34, J-37, J-39
Coil Cabinet 24"	E-50, E-52, E-53	Electric Range Burner	G-7
Coil Cabinet E2/E3- KD	E-27	Electrical Tape Black 3/4" x 20 Yards	L-4
Coil Cabinet W/ Filter	E-27	Element 120v 1750w	J-8
Coil Cabinet- Louvered Grille Only	E-27	Elixir Door Hinge	H-60
Coil-Revolv AccuCharge® "M" Series	E-22	Elixir Series 200 Outswing Door	H-50
Coil-Revolv Sweat Fit	E-20	Elixir Series 4000 Combination Door	H-58
Coil-Revolv Service Coil	E-24	Elixir Series 6000 Combination Door	H-52
Collet Clip	J-31	End Stop 1/2"	J-32
Combination Drip Pan & Ring 8"	G-8	Exhaust Fan	G-5
Combustible Base	E-50, E-52, E-53	Exhaust Fan Replacement Grill	G-5
Concentric Vent Kit With Roof Flashing	E-50, E-52	Exterior Fixture Plastic Black	F-7
Concrete Anchors	D-2	Exterior Gas Connector	J-8
Condensation Drain Trap 3/4"	E-55	Eye Anchors	D-10
Connector	E-55	EZ Anchor	D-2
Construction Adhesive	L-3	-F-	
Control Package	E-28	Fabric Flex Duct Strap 1 3/4" x 300'	E-34
Copper Crimp Ring	J-38	Face Window Lineal 3 1/2"	B-40
Coral Mobile Home Specialty Anchor 36" x 5/8" W/3	D-2	Fan Blade - Range Hood	G-7
Coupler 1/2" x 1/2" 25 Bag	J-38	Fan Blade - Range Hood Square Outlet	G-7
Coupler 3/4" x 3/4" 25 Bag	J-38	Faucet Tub/Shower, Diverter 8" Center	J-24
Coupling Poly / Pex	J-35	Faucets	J-24, J-25, J-26, J-27, J-28, J-29
Couplings/Nipples	J-40	Female Connectors	J-32
Crimp Tool	J-38, K-2	Female Elbow 3/4" MPT x 1/2" FPT	J-40
Cross x" Drive Head Only	D-2	Female Pipe Adapter Brass 3/4" Pex x 3/4" SFP	J-37
Cross "x" Drive Rods Only 30" x 3/4" 8/Bundle	D-2	Female Pipe Adapters Brass 1/2" Pex x 1/2" FP	J-37
Crown Molding	B-37, B-38	Female Pipe Adapters Brass 3/4" Pex x 3/4" FP	J-37
Crown Molding White 2 1/2" x 10'	H-72	Female Swivel Elbow 1/2"	J-31
-D-		Female Swivel Elbow 3/8"	J-31
Deadbolt Polished	H-62	Fiberglass Pipe Insulation	I-1
Deep-Set Tie Down Anchors Anchor Deep Set 36" x 3/4"	D-2	Fiberglass Steps	B-3, B-4, B-5, B-6, B-7
Dielectric Nipple 3/4" MPT x 3/4" MPT	J-8	Filter For Blend Air System	E-57
Dishwasher Water Line Hook Up Kit	G-3, G-9	Finish Trim 3/4" Face	B-34
Dishwasher, Built-In 24" - White	G-3	Flag On Staff	C-5
Door Knob	H-62	Flange	J-29
Door Lite	H-43	Flange, 8" Center	J-28
Door-Patio	H-40, H-42	Flat Washer 3/8" x 1 1/2" Zinc	D-8, K-2
Double Beam Clamp W/ Bolt And Nut	D-5	Flex "J" 3/4" Opening	B-36
Double Eye Cast Equalizer	C-3	Flex Ducts	E-33
Double Slot Buckle	D-3	Flex-Mend 4" x 180' Roll	L-4
Double Slot Strap Buckle Only	D-4	Flexible Metallic Duct	G-10
Draft Cap 4" Flue Size	E-57	Flexible Transition Couplings	I-6
Draft Cap 5" Flue Size	E-57	Flush Valve 10 3/4"H With Ball & Chain	J-21
Drain & Plug	J-18	Foam Sealer, 5 1/2" x 50'	D-9, L-6
Drain Tip Toe W/Locknut	J-20	Foil Tape UL 181 2" x 60 Yards	L-4
Drawband 36" Length	E-34	Food Waste Dispose 1/2 HP	G-10
Drawer Single Track Set	H-72	Foundation Vent Inserts	B-16
Drip Cap-Mill Finish	H-60	Foundation Vents Automatic - Black	B-17
Drip Pan	G-8	Frame Bracket Angled W/Bolts And Nuts - 24 Per Box	D-5
Drop Ear Elbow 1/2"	J-31	Frame Hooks	D-3
Drop Ear Elbow 1/2" x 1/2" Poly / Pex	J-33	Frieze Runner "F" Channel	B-35
Dry Stacked Stone Corner Limestone	B-21	Frost- Free Silcock Valve 1/2" x 10"	I-4
Dryer Receptacle 125 / 250v	F-10	Furnace - Electric	E-36, E-38
Dryer - Electric 6.5 Cubic Foot - White	G-4	Furnace Filters	E-58

## INDEX BY ALPHABET

Furnace Filtritech Fab Blue 16" x 20" Washable	E-57	Kitchen Sink Double Stainless Steel	J-19
Furnace Gas-80%	E-40	Kitchen Sink Tubular Tailpiece, 1 1/2" x 6" Brass Flanged, 22 Ga.	J-19
Furnace Gas-95%	E-42	Knob/Wall Guard	H-61, H-72
Furnace Oil, Downflow	E-44	Knocker Viewer-Brass	H-61
Furnace-Gas VMA 95%	E-52	Kool Seal Acrylic Patching Cement .9 Gal.	L-2
Furnace-Gas VMC 95%	E-50	Kool Seal Elastomeric Finish Coat 4.75 Gal.	L-1
-G-		Kool Seal Fibered Aluminum Roof Coat .9 Gal.	L-2
Gasket For 501122	J-20	Kool Seal Fibered Aluminum Roof Coat 4.75 Gal.	L-2
Gasket Needed For Bathtub Drain 52227	J-18	Kool Seal Premium Elastomeric Finish Coat .9 Gal. Roof Coating	L-1
Gate Valves	I-4	Kool Seal Premium Elastomeric Finish Coat 4.75 Gal. Roof Coating	L-1
Globe Alabaster 11"	F-4	Kool Seal Premium Fibered Aluminum Roof Coat .9 Gal. Premium	L-1
Globe Alabaster 6"	F-1	Kool Seal Premium Fibered Aluminum Roof Coat 4.75 Gal. Premium	L-1
Globe Alabaster 7"	F-2	-L-	
Globe Alabaster Bell	F-5	Lag Screws	D-8, K-2
Globe Clear Barrel 6"	F-1, F-7	Lateral Brace Tube W/Hardware 60" Adj. - Galvanized	D-13
Globe Etched Diamond Glass 9"	F-3	Lavatory Sinks	J-18
Globe Plastic Diffuser 14"	F-5	Lever, Fluidmaster	J-21
Globe Square Glass 12"	F-5	Light Bulb For Appliance 40w	G-10
Globe White 6"	F-1	Lineset-Quick Connect	E-9
Grease Cap	C-5	Liquid-Tight Conduit	E-55
Grease Seal	C-4	Longitude Beam Clip	D-5
Grille Only	E-33	Longitude Brace Tube W/Beam Clip Galvanized	D-13
Ground Fault Circuit Interrupter	F-10	Longitude Flex Tube Galvanized	D-14
Ground Spikes 8"	B-13	Longitude Hardware Kit	D-18
-H-		Longitude Struts For "Concrete Systems" 65" L Pier Height Up To 6 Blocks	D-18
Handle Hot & Cold	J-29	Longitude Struts For "Ground Systems"	D-17
Harbour Crest Vinyl Siding	B-29, B-30, B-31	-M-	
Heat Cable	I-1	Magnetic Bit Holder, 1/4", Body Diameter 7/16", Stainless Steel	K-1
Heat Strips	E-30, E-32	Male Elbow 1/2"	J-32
Heavy Duty Lug Bolt	C-4	Male Elbows 1/2" x 1/2" Poly / Pex	J-34
Heavy Hex Lug Bolt Plated	C-4	Male Elbows 1/2" x 3/8" Poly / Pex	J-34
Hex Head Screws	H-61, K-2, K-3	Male Pipe Adapters Brass 1/2" Pex	J-37
Hex Locknut 5/16" x 18 Thread	C-3	Male Pipe Adapters Brass 3/4" Pex	J-37
Hose Bibb Valve Rough Brass	I-4	Mansfield Tank Lever	J-21
Hose Washer 3/4", Vinyl	J-19	Mansfield Water Saver Flush Valve 10 3/4"H.	J-21
Hydraulic Bottle Jacks	D-6, K-4	Metal Flashing Aluminum	D-9, E-58
-I-		Metal Floor Registers	E-56
Ice Maker Tee W/Valve	J-34	Metal Studs	B-16
Immersion Elements	J-8	Metal Wye	E-33, E-34
In-Line Check Valve Brass, 3/4" Pipe	I-3	Micro Channel Coil	E-4, E-18
Inside Corner	J-17	Microwave, Over-The-Range 1.5 Cu. Ft. - White	G-5
Inside Corner 9 Ft. 5/16" x 1" x 8'	H-71	-N-	
Inside Corner Post	B-34	Nails 1 1/2"	B-13
Installation Kit W/Poly Tube - 25'	G-9	Novik DS Dry Stacked Stone Corner	B-20
-J-		Novik DS Dry Stacked Stone Panel	B-21
J-Casing Wide	B-39	Novik Hand-Cut Stone Corner	B-19
J-Channels	B-29, B-30	Novik Hand-Cut Stone Panels	B-19
Jeld-Wen Interior Doors	H-70	Novik Hand-Laid Brick Corner	B-18
Jig	B-13	Novik Hand-Laid Brick Panel	B-18
-K-		Novik SK Stacked Stone Corner	B-21
K-Rok Panel Access Doors	B-16	Novik SK Stacked Stone Panel	B-21
K-Rok Panels	B-16	Nut Setters	K-1
Kinro Series 18000 Horizontal Slider Aluminum Main Window	H-34	Nut/Ring/Cone Sets	J-39
Kinro Series 18000 Window Aluminum Vertical Slider Main Window	H-34	Nylon Tricot Flag	C-5
Kinro Series 5140 Outswing Doors	H-22	-O-	
Kinro Series 5140 Utility Doors	H-26	One Piece Surrounds	J-13
Kinro Series 5210 Inswing Combination Doors	H-20	Outdoor Vent Extension 18"	J-4
Kinro Series 5500 Outswing Steel Entry Doors	H-24	Outside Corner 4"	B-33
Kinro Series 5600 Storm Doors	H-28	Outside Corner Post 3"	B-33
Kinro Series 9750 Vinyl Double Pane Single Hung Windows	H-38	Outside Corners	H-71
Kinro Series 5700 Self Storing Storm Window	H-36	Outside Vent Cover	G-7
Kinro Series 5900 Heavy Duty Storm Doors	H-30	-P-	
Kinro Series 7660 House Type Steel 6 Panel Door Without Windows	H-12	Packaged Heat Pump 14 SEER	E-32
Kinro Series 7660 House Type Steel Door With Brass Full Oval Windows	H-18	Packaged Systems Accessory Kit	E-33
Kinro Series 7660 House Type Steel Door With Sunburst Windows	H-16	Pads A/C 24 x 24 x 2"	E-56

## INDEX BY ALPHABET

Paint-Elixir Door White .....	H-60	Rail - Deluxe Rail .....	B-3, B-4, B-5, B-6
Paint-Kinro Door-White For 7600 Series .....	H-44	Rail - Standard Back Rail .....	B-5, B-6
Painted Twin Disk Anchors .....	D-1	Rail - Standard Rail .....	B-3, B-4, B-5, B-6, B-7
Panel Nails .....	H-62, K-2	Rain-R-Shine PVC Cement .....	I-9
Patio Door Handle Kits .....	H-44	Range Cord 50 Amp 4' , 4 Wire .....	F-9, G-9
Peel N' Seal Silver .....	L-4	Range Hood Fan Motor 115v .....	G-6
Permalux Garden Tubs .....	J-15	Range Hood Filter Grease 8" x 8" .....	G-6
Permalux Standard Tubs .....	J-14	Range Hood Outlet Adapter .....	G-6
Perrenia Exhaust Vent Kit .....	B-50	Range Hood, Vented, White, 12" x 30" .....	G-6
Perrenia Mini Mount .....	B-50	Range Receptacle U.L. Listed, 125 / 250v .....	F-10
Perrenia Recessed Split Mount .....	B-50	Rapid Wall 12' Trim Back .....	B-25
Perrenia Standard Mount .....	B-50	Rapid Wall 12' Trim Front Rail .....	B-25
Pex Stop Valve ½" .....	J-37	Rapid Wall 12' Trim Ground Rail .....	B-26
Phillips Recess Screws 1" .....	H-62	Rapid Wall 12' Trim Kits With Hardware .....	B-26
Pier Pads .....	D-7	Rapid Wall 4' x 12' Panel .....	B-25
Pipe Cap .....	J-35	Rapid Wall-Undermount Trim Kit .....	B-26
Pipe Clamps .....	I-2, J-22	Reducer Increaser .....	E-34
Pipe Hanger Straps .....	D-9, E-34, I-2	Reducing Stem ¾" x ½" .....	J-32
Pipe Insulation 6' .....	I-1	Reducing Tee .....	J-32
Pipe Joint Compound 2 Oz Tube .....	I-9	Reducing Unions .....	J-32
Pipe Swivels & Adapters ¾" Hose x ¾" Pipe Swivel .....	I-3	Register Collars .....	E-57
Plastic Finials .....	F-5	Regulating Valve .....	I-3
Plastic Flag Clips .....	C-5	Renu Seat-Garden .....	J-28
Plastic Pipe Primer - Cleaner .....	I-9	Return Air Kit W/Grille .....	E-33
Plastic Pipe PVC Cement Pint .....	I-9	Revolv Coil Universal Drain Pan .....	E-20, E-22
Plenum/Duct Connectors .....	E-45, E-47	Revolv Packaged Air Conditioners 14 SEER .....	E-30
Plug ½" Pex Only .....	J-35	Revolv Service Coil .....	E-24
Plug ¾" Pex / Flair .....	J-35	Rim Clamp Plated .....	C-4
Plug Kit .....	I-1	Rivets Almond .....	J-17
Plug PO Chrome 5" .....	J-19	Rocker Switch Cover Plates .....	F-11
Plumbing Stem and Bonnet - Utopia Replacement .....	J-27	Rocker Switches .....	F-11, F-12
Pocket Penetrometer W/ Canvas Case .....	D-7, K-2	Roof Bracket Heavy Duty - Galvanized .....	D-4
Poly Film Sheeting .....	C-5, D-8	Roof Caps .....	F-10
Pop Up W/O Overflow .....	J-29	Roof Cement Coat .9 Gal. ....	L-2, L-3
Porch Lantern Brushed Nickel .....	F-7	Roof Coat Wooden Brush .....	L-6
Porch Light W/Globe .....	F-8	Roof Jacks .....	E-45, E-46
Porch Ceiling Panel .....	B-41, B-42	Roof Stacks .....	J-4
Power Bits .....	K-1	Rosettes 1" White .....	K-1
Power Range Hood .....	G-5	Rubber Flapper Tank Ball W/Chain & Hook .....	J-21
Premium Plus Bulk .....	B-9, B-11, B-15	Rumble Button .....	D-9
Premium Plus Center Vent .....	B-9	-S-	
Premium Plus Trim Kit .....	B-9, B11	Sag-Ender .....	L-5
Pro-Vent With 1 ½" MPT .....	J-18	Schedule 40 PVC Pipe .....	I-3
Propride 4.5" Dutchlap .....	B-49	Screen Replacements .....	H-40, H-42 H-43
Push Button Latch 1 ¾"Black .....	H-61	Screw/Nut Driver, 6 In 1 .....	K-1
Putty Tape .....	H-62, L-4	Sewer Ring .....	I-6
PVC 22-½° Elbow 3" .....	I-7	Shackle Bolt Plated .....	C-3
PVC 3/4" Ball Valve .....	I-2	Shackle Link .....	C-3
PVC 45° Elbow 3" .....	I-7	Shock Cords 18" Length .....	C-5, K-3
PVC 90° Long Turn Elbow 3" x 3" .....	I-7	Shoe/Stop .....	H-71
PVC 90° Vent Elbow 3" x 3" .....	I-7	Shower Arm .....	J-29
PVC All Purpose Cement 1 Pint .....	I-9	Shower Base 27" x 54" - Aquatic .....	J-9
PVC Clean Out Adapter 3" .....	I-7	Shower Base Composite 32" x 32" A2 - White - Aquatic .....	J-11
PVC Coupling 3" x 3" .....	I-7	Shower Curtain Rod Aluminum, 60" W/Flange .....	J-17
PVC Coupling ¾" .....	I-2	Shower Doors .....	J-16
PVC Elbow 90° ¾" .....	I-2	Shower Heads .....	J-28
PVC Elbows - Street 3" x 3", 90° .....	I-7	Shower Pan One Piece .....	J-13
PVC Long Turn Tee Wye 3" .....	I-7	Shower Strainer 3 ½" .....	J-18
PVC Sanitary Tee 3" .....	I-7	Shower Surround .....	J-13
PVC Threaded Plug 3" .....	I-7	Shower Wall Back Composite 32" x 74" A2 - White - Aquatic .....	J-11
Pvc Trim Coil 24" .....	B-44	Shower Wall Side Composite 32" x 74" A2 - White - Aquatic .....	J-11
Pvc Trim Coil 24" Striated Pvc Finish .....	B-45	Shutter - Colonial Raised Panel 12" .....	B-47
-R-		Shutter - Traditional Open Louver 12" .....	B-47
Rail - For B Models .....	B-7	Sign-Oversize Load-Mesh 20" x 7' .....	C-5
Rail - Deluxe Back Rail .....	B-5, B-6	Sign-Metal 2 Side-Oversize .....	C-5

## INDEX BY ALPHABET

Sign-Nylon-Multi Size .....	C-5	TDR Switch .....	E-55
Silicone Sealant White Caulk 10.2 Oz .....	L-3	Tees .....	J-39
Silicone Sealants Clear Caulk 10.2 Oz .....	L-3	Teflon Thread Seal Tape .....	L-4
Silver Cloth Duct Tape UI 181 2" x 60 Yards .....	L-4	Temperature Relief Valve Long Body .....	J-8
Sink Rim Clamp .....	J-19	Thermocouple And Adaptor 30" Kit .....	E-57
Sink Strainer Stainless Steel 4" .....	J-19	Thermostat Digital Programmable T-Stat Multifunction .....	E-25, E-61
Skirt Hang'r Metal Skirting Bracket .....	B-13	Thermostat Outdoor/Single .....	E-56
Slip Joint Nut/Washer .....	J-20	Thermostat-Cool Only .....	E-25, E-59
Sloped Roof Flashings .....	E-45	Thermostat-Digital Programable Heat Pump (2H1C) .....	E-25, E-61
Slotted Split Bolt/Nut .....	D-3	Thermostat-Heat Only .....	E-25, E-59
Smoke Alarms .....	F-9	Thermostat-Heating/Cooling - 4 Wire Pigtail .....	E-25, E-59
Snap Lock Punch ½" Throat Depth 8 ½" Long .....	B-13, K-1	Thermostat-Heating/Cooling 5 Wire .....	E-25, E-59
Socket Wrench Screw-In Element .....	J-8	Thermostats Digital Non Programmable .....	E-25, E-60
Soil Test Probe W/ Carrying Case & Torque Wrench Instruction .....	D-7, K-3	Thermostats Single Pole Element W/HLC .....	J-8
Spikes 100 - 8" & Nails 200 1-½" .....	B-13	Thermostats Single Pole, Lower Element .....	J-8
Spikes 100 - 8" & Screws 200 #8 .....	B-13	Thermostats Upper W/High Limit .....	J-8
Split System AccuCharge® Air Conditioners 13 SEER .....	E-4, E-18	Threshold Doors and Windows .....	H-60, H-61
Split System Quick Connect Heat Pumps 14 SEER .....	E-8, E-18	Tie 4-Bolt Longitudinal Frame .....	D-5
Split System Sweat Fit Air Conditioners 13 SEER .....	E-12	Toggle Switch Single Pole Cover Plate .....	F-12
Split System Sweat Fit Heat Pumps 14 SEER .....	E-16, E-18	Toilet Bolt Set ¾" x 3" .....	J-21, K-4
Spout Garden Tub ½" Inlet .....	J-29	Toilet Bowl White .....	J-20
Spray Adhesive 16 Ounce Can .....	L-5	Toilet Complete Units .....	J-20
Sprayer And Hose Metal .....	J-27	Toilet Hold Down Fasteners W/Nuts ¼" x 2 ¼" .....	J-21, K-4
Spring Seat .....	C-3	Toilet Seats .....	J-18
Spring Door Stop/Brass 3" .....	H-61	Toilet Tank Float Ball Black Plastic 4" x 5" .....	J-22
Spring Hangers .....	C-3	Toilet Tank White W/Acc .....	J-20
Spring Tie Plate .....	C-3	Transition Molding .....	B-39
Squeak - Ender .....	L-5	Travel Sticks 1 ¼" x ⅝" x 8' Ply Nt .....	D-8
Stabilizer Plates .....	D-5	Trim Coil 24" Smooth .....	B-42, B-43
Stackable Elbow ½" .....	J-31	Trim Ring 6" .....	G-8
Stackable Tees ½" .....	J-32	Trim Ring Only 8" .....	G-8
Steel Equalizer Cast .....	C-3	Tub - Aquatic .....	J-9
Steel Pier Pad W/16" Pins Galvanized .....	D-13	Tub - Garden Tub - Aquatic .....	J-10
Stem & Bonnet Assembly Fittings .....	J-28	Tub Heavy Duty .....	J-12
Stop Valve MPT .....	J-40	Tub Molding .....	J-17
Stop Valves .....	J-31	Tub Spout .....	J-28
Storage Building Anchor Kit 15" Anchor Length .....	D-10	Tub Standard .....	J-12
Storm Door Closer Black .....	H-44, H-60, H-61	Tub Trim Kit .....	J-17
Stove Bolts ¼" x ¾" W/Nut .....	D-9, I-2, K-1	Tub Wall Kits Aquatic .....	J-9
Straight Valves .....	J-35	Tuff-Pex Tubing .....	J-37
Strainer Adapters .....	J-20	Twin Disk Anchors Helix - Galvanized .....	D-1
Strainer Kitchen Sink 3 ½" Twist Top Basket .....	J-19	TXV Kit R410A Revolv .....	E-22
Strainer Kitchen Sink Basket Only For 5220002 .....	J-19	-U-	
Strap Crimp Tool for 1 ¼" Strap .....	D-7, K-2	U-Bolts ½" - 20 Thread .....	C-4
Strap Seal For 1 ¼" Strap .....	D-4	Union Check Valve ½" .....	J-31
Straps Galvanized .....	D-3	Union Connectors .....	J-31
Street Elbow ½" MPT x ½" FPT .....	J-40	Union Tees .....	J-31
Strut For Longitudinal Systems .....	D-16, D-17, D-18	Universal Quick Assemblies .....	D-3
Stub Kits Outdoor .....	E-10	Universal Receptacle .....	G-9
Subfloor & Construction Adhesive - 10.5 Oz. 12/Box .....	L-3	Universal Soffit Vinyl .....	B-44, B-45
Sweat Fit-A/C 13 SEER (Piston) .....	E-18	Universal Soffit Vinyl Soffit/Basket Weave Vented 12" .....	B-45
Sweat Fit-A/C 14 SEER (TXV) .....	E-18	Universal Tubing Cutter For ⅜"- ¾" Tubing .....	J-38, K-1
Swing Check Valve .....	I-3	Utility Knives .....	K-2
Switch - Fan, Rocker Black 1 Speed .....	G-6	-V-	
Switch - Fan, Rocker Black 2 Speed .....	G-7	Vanity Bar 18" Brushed Nickel .....	F-6
Swivel Elbows .....	J-33	Vanity Pendant Brushed Nickel 18" 2 light .....	F-6
Swivel Elbows Pex .....	J-37	Vector Lateral Hardware Kit (Florida) .....	D-15
Swivel Straight Couplings FPT Poly / Pex .....	J-35	Vector Systems .....	D-15, D-16, D-18
Swivel Straps .....	D-3	Vent Caps .....	I-4
-T-		Vent Transition RG 7 - 8" .....	E-47
T-Channels .....	B-35, B-36	Vinyl Fascia .....	B-40
T2-6" Beaded-Solid Porch Ceiling Panel .....	B-43	Vinyl Soffits .....	B-40, B-41
T2-6" Beaded-Vented Porch Ceiling Panel .....	B-44	Vinyl Starter Strip .....	B-39
Tank Lever - Standard Lever 8" Metal Arm, Plastic Spud .....	J-21	VMC-3" x 4" Draft Transition .....	E-50, E-52, E-53
Tarp Straps .....	C-5, K-2	VMC-3" x 5" Draft Transition .....	E-50, E-52, E-53

## INDEX BY ALPHABET

VMC-Concentric Vent Kit .....	E-50, E-52, E-53
VMC-Roof Flashing Kit .....	E-50, E-52, E-53
VMC-Roof Jack Close-off .....	E-50, E-52, E-53
-W-	
Washer 3.6 Cubic Foot - White .....	G-4
Washer Inlet Hoses 4' 2 Pack .....	G-4, G-9
Waste Outlet Universal, 16"-21" Telescopic .....	J-19
Waste Outlet, Universal .....	J-20
Water Heater Doors .....	H-69, J-7
Water Heater Electric .....	J-2
Water Heater Gas .....	J-4
Wax Gasket .....	J-20
WD-40 Lubricant 8 Ounce Spray Can .....	L-5
Wedge Hardwood .....	D-8
Wedge Pine .....	D-8
White Rivets .....	J-17
White Rosette Screws 1 ½" .....	K-1
Wind Stay Rods .....	B-13
Window Latch Repair Kit For 18000 Series Windows .....	H-44
Window Latch Repair Kit For 9750 Series Windows .....	H-44
Window Lineal 5" Face .....	B-41
Window Lineal Foam Insert .....	B-41
Window/Door Molding .....	B-37, B-36
-X-	
xi Lateral Stabilization Struts Lateral Strut, 5' W/Hardware .....	D-18
xi Steel Pier With Longitudinal System .....	D-18
xi2 Concrete Foundation System .....	D-18
xi2 Ground Foundation System .....	D-17



## INDEX BY PART NUMBER

017142436	Fiberglass Steps - The Economaster - 14" H x 36" W	B-3	02329	Rail - Standard Rail	B-5
017142972	Fiberglass Steps - The 72" Wide - 14" H x 72" W	B-6	02338	Rail - Standard Rail	B-6
017143838	Fiberglass Steps - The Platform Step - 14" H x 38" W	B-6	0238	Rail - Standard Back Rail	B-6
017212436	Fiberglass Steps - The Economaster - 21" H x 36" W	B-3	02424	Rail - Standard Rail	B-3, B-4
017212948	Fiberglass Steps - The 48" Wide - 21" H x 48" W	B-5	02429	Rail - Standard Rail	B-5
017212972	Fiberglass Steps - The 72" Wide - 21" H x 72" W	B-6	02438	Rail - Standard Rail	B-6
017213838	Fiberglass Steps - The Platform Step - 21" H x 38" W	B-6	0248	Rail - Standard Back Rail	B-5, B-6
017281836	Fiberglass Steps - The "B" Series - 28"	B-7	02524	Rail - Standard Rail	B-3
017282436	Fiberglass Steps - The Economaster - 28" H x 36" W	B-3	02538	Rail - Standard Rail	B-6
017282436WHB	Fiberglass Steps - The Economaster Display Unit - 28" H x 36" W	B-4	02538747000	Thermostat-Heating/Cooling - 4 Wire Pigtail	E-25, E-59
017282948	Fiberglass Steps - The 48" Wide - 28" H x 48" W	B-5	029124	Rail - Deluxe Rail	B-3
017282972	Fiberglass Steps - The 72" Wide - 28" H x 72" W	B-6	029129	Rail - Deluxe Rail	B-5, B-6
017283838	Fiberglass Steps - The Platform Step - 28" H x 38" W	B-6	029138	Rail - Deluxe Rail	B-6
017283848	Fiberglass Steps - The Platform Step - 28" H x 48" W	B-6	029224	Rail - Deluxe Rail	B-3, B-4
017352436	Fiberglass Steps - The Economaster - 35" H x 36" W	B-3	029229	Rail - Deluxe Rail	B-5, B-6
017352436WHB	Fiberglass Steps - The Economaster Display Unit - 35" H x 36" W	B-4	029238	Rail - Deluxe Rail	B-6
017352948	Fiberglass Steps - The 48" Wide - 35" H x 48" W	B-5	029324	Rail - Deluxe Rail	B-3, B-4
017352972	Fiberglass Steps - The 72" Wide - 35" H x 72" W	B-6	029329	Rail - Deluxe Rail	B-5, B-6
017353838	Fiberglass Steps - The Platform Step - 35" H x 38" W	B-6	029338	Rail - Deluxe Rail	B-6
017353848	Fiberglass Steps - The Platform Step - 35" H x 48" W	B-6	02938	Rail - Deluxe Back Rail	B-6
017423838	Fiberglass Steps - The Platform Step - 42" H x 38" W	B-6	029424	Rail - Deluxe Rail	B-3, B-4
017493838	Fiberglass Steps - The Platform Step - 49" H x 38" W	B-6	0294247	Rail - Deluxe Rail	B-3, B-4
018161836	Fiberglass Steps - The "B" Series - 16"	B-7	029429	Rail - Deluxe Rail	B-5, B-6
018162436	Fiberglass Steps - The Economaster - 16" H x 36" W	B-3	0294297	Rail - Deluxe Rail	B-5
018162948	Fiberglass Steps - The 48" Wide - 16" H x 48" W	B-5	029438	Rail - Deluxe Rail	B-6
018162972	Fiberglass Steps - The 72" Wide - 16" H x 72" W	B-6	0294387	Rail - Deluxe Rail	B-6
018163838	Fiberglass Steps - The Platform Step - 16" H x 38" W	B-6	02948	Rail - Deluxe Back Rail	B-5, B-6
018163848	Fiberglass Steps - The Platform Step - 16" H x 48" W	B-6	029524	Rail - Deluxe Rail	B-3
018241432	Fiberglass Steps - Economy Step - 24" H x 14" W	B-7	029538	Rail - Deluxe Rail	B-6
018241836	Fiberglass Steps - The "B" Series - 24"	B-7	0295387	Rail - Deluxe Rail	B-6
018242436	Fiberglass Steps - The Economaster - 24" H x 36" W	B-3	03020001	Wedge Hardwood 1" x 4" x 12" N/T	D-8
018242436WHB	Fiberglass Steps - The Economaster Display Unit - 24" H x 36" W	B-4	03041616	Pier Pad 16 x 16"	D-7
018242948	Fiberglass Steps - The 48" Wide - 24" H x 48" W	B-5	03041818	Pier Pad 18 1/2" x 18 1/2"	D-7
018242972	Fiberglass Steps - The 72" Wide - 24" H x 72" W	B-6	03042020	Pier Pad 20" x 20"	D-7
018243838	Fiberglass Steps - The Platform Step - 24" H x 38" W	B-6	03101	Wedge Hardwood 3" x 8" x 1" N/T	D-8
018243848	Fiberglass Steps - The Platform Step - 24" H x 48" W	B-6	03140	Wedge Hardwood 4" x 8" x 1" Treated	D-8
018321432	Fiberglass Steps - Economy Step - 32" H x 32" W	B-7	0315280	Wedge Pine 8" x 4" x 1" P/T	D-8
018321836	Fiberglass Steps - The "B" Series - 32"	B-7	03154	Wedge Hardwood 4" x 1 2" N/T	D-8
018322436	Fiberglass Steps - The Economaster - 32" H x 36" W	B-3	03160	Wedge Hardwood 3" x 9" x 1" N/T	D-8
018322436WHB	Fiberglass Steps - The Economaster Display Unit - 32" H x 36" W	B-4	03170	Board Hardwood 1" x 8" x 16" Treated	D-8
018322948	Fiberglass Steps - The 48" Wide - 32" H x 48" W	B-5	03180	Board Hardwood 2" x 8" x 16" Treated	D-8
018322972	Fiberglass Steps - The 72" Wide - 32" H x 72" W	B-6	031800	Board Hardwood 1" x 8" x 16" N/T	D-8
018323838	Fiberglass Steps - The Platform Step - 32" H x 38" W	B-6	031805	Wedge Hardwood 3/4" x 4" x 8" N/T	D-8
018323848	Fiberglass Steps - The Platform Step - 32" H x 48" W	B-6	0318110	Board Pine 1" x 8" x 16" P/T	D-8
018402436	Fiberglass Steps - The Economaster - 40" H x 36" W	B-3	031825	Board Pine 2" x 8" x 16" P/T	D-8
018402436WHB	Fiberglass Steps - The Economaster Display Unit - 40" H x 36" W	B-4	03190	Wedge Hardwood 4" x 8" x 1" Treated	D-8
018402948	Fiberglass Steps - The 48" Wide - 40" H x 48" W	B-5	031900	Board Hardwood 2" x 8" x 16" N/T	D-8
018402972	Fiberglass Steps - The 72" Wide - 40" H x 72" W	B-6	03212830	Trvl Sticks 1 1/16" x 5/8" x 8' Ply Nt	D-8
018403838	Fiberglass Steps - The Platform Step - 40" H x 38" W	B-6	032424	Pier Pad 24" x 24"	D-7
018403848	Fiberglass Steps - The Platform Step - 40" H x 48" W	B-6	032905	Board Hardwood 2" x 8" x 16" N/T	D-8
018482436	Fiberglass Steps - The Economaster - 48" H x 36" W	B-3	033001	Blocking Pier Head W/Nut	D-4
018483838	Fiberglass Steps - The Platform Step - 48" H x 38" W	B-6	033008	Blocking Pier Steel 8" Red	D-4
02114M	Rail - Standard Rail	B-7	033010	Blocking Pier Steel 10" Red	D-4
02118	Rail	B-7	033012	Blocking Pier Steel 12" Red	D-4
02124	Rail - Standard Rail	B-3	033014	Blocking Pier Steel 14" Red	D-4
02129	Rail - Standard Rail	B-5, B-6	033016	Blocking Pier Steel 16" Red	D-4
02138	Rail - Standard Rail	B-6	033018	Blocking Pier Steel 18" Red	D-4
02214M	Rail - Standard Rail	B-7	033020	Blocking Pier Steel 20" Red	D-4
02218	Rail	B-7	033022	Blocking Pier Steel 22" Red	D-4
02224	Rail - Standard Rail	B-3, B-4	033024	Blocking Pier Steel 24" Red	D-4
02229	Rail - Standard Rail	B-5, B-6	033026	Blocking Pier Steel 26" Red	D-4
02238	Rail - Standard Rail	B-6	033028	Blocking Pier Steel 28" Red	D-4
02314M	Rail - Standard Rail	B-7	033030	Blocking Pier Steel 30" Red	D-4
02318	Rail	B-7	0359300	Pier Pad 16" x 18", 12/Bdl	D-7
02324	Rail - Standard Rail	B-3	0359302	Pier Pad 17" x 25", 5/Bdl	D-7

## INDEX BY PART NUMBER

05010001	Food Waste Dispose 1/3 HP	G-10	1136363D	Pad A/C 36 x 36 x 3"	E-56
050130	Installation Kit W/Poly Tube - 25'	G-9	1136368HP	Pad H/P W/Riser 36" x 36" x 8"	E-56
050151	Dryer Unit Kit	G-10	1136483D	Pad A/C 36 x 48 x 3"	E-56
050152	Flexible Metallic Duct	G-10	1138524Ht	Pad-AC 38" x 52" x 4"-175 mph	E-56
050153	Dryer Vent Kit Flexible Alum. Duct - Rigid 8'	G-10	114106	Register Collars 4" W x 10" D x 6" Long	E-57
050164	Clamp Hose 3 3/8" To 4 1/2"	G-10	1145583D	Pad A/C 45 x 58 x 3"	E-56
050166	Washer Inlet Hoses 4' 2 Pack	G-4, G-9	1145584	Pad A/C 45 x 58 x 4"-150 mph	E-56
05020002	Dryer Cord 4'; 30 Amp	F-9, G-9	1145584Ht	Pad-AC 45" x 58" x 4"-175 mph	E-56
05310005	Dishwasher, Built-In 24" - White	G-3	11486	Register Collars 4" W x 8" D x 6" Long	E-57
05310006	Microwave, Over-The-Range 1.5 Cu. Ft. -White	G-5	115012	Return Air Kit W/Grille 12"	E-33
05A772	Washer 3.6 Cubic Foot - White	G-4	115014	Return Air Kit W/Grille 14"	E-33
05A881	Electric Dryer 6.5 Cubic Foot - White	G-4	1152523D	Pad A/C 52 x 52 x 3"	E-56
05A882	Dryer - Gas 6.5 Cubic Foot - White	G-4	1161025	Flex Duct 10" x 25' R6	E-33
07540020	Furnace Filter- /C1" x 18" x 24"	E-58	1161026	Furnace Filter 1/4" x 16" x 26" Foam For Miller/Intertherm	E-58
08540003	Furnace-Gas-50k-95% -3.5 T-VMA	E-52	1161036	Furnace Filter 1/4" x 19" x 26" Foam For Miller/Intertherm	E-58
08540004	Furnace-Gas-75k-95% -3.5 T-VMA	E-52	1161225	Flex Duct 12" x 25' R6	E-33
08540005	Furnace-Gas-50k-95% -3.5 T-VMC	E-50	1161425	Flex Duct 14" x 25' R6	E-33
08540006	Furnace-Gas-75k-95% -4.0 T-VMC	E-50	1162036	Furnace Filter 1/4" x 19" x 36" Foam	E-58
08540007	Furnace-Gas-50k-95% -3.5 T-VMC-Es	E-50	1163054	Furnace Filter 1/4" x 19" x 54" Foam For Miller/Intertherm	E-58
08540008	Furnace-Gas-75k-95% -4.0 T-VMC-Es	E-50	116507	Pipe Hanger Strap Galvanized 3/4" x 100' 28 Gauge Roll D-9, E-34, I-2	
08560001	Combustible Base	E-50, E-52, E-53	1178401	Metal Floor Register 4" x 10" White	E-56
08560002	Concentric Vent Kit With Roof Flashing	E-50, E-52	1178407	Metal Floor Register 4" x 10" Brown	E-56
08560003	Coil Cabinet 20"	E-50, E-52, E-53	1178481	Metal Floor Register 4" x 8" White	E-56
08560004	Coil Cabinet 24"	E-50, E-52, E-53	1178487	Metal Floor Register 4" x 8" Brown	E-56
08560005	VMC-Concentric Vent Kit	E-50, E-52, E-53	1181225	Flex Duct 12" x 25' R8	E-33
08560006	VMC-Roof Flashing Kit	E-50, E-52, E-53	1181425	Flex Duct 14" x 25' R8	E-33
08560007	VMC-3" x 4" Draft Transition	E-50, E-52, E-53	11923	Thermocouple And Adaptor 30" Kit	E-57
08560008	VMC-3" x 5" Draft Transition	E-50, E-52, E-53	119401	Furnace Filter 15 1/2" x 20" Metal	E-58
08560009	VMC-Roof Jack Close-off	E-50, E-52, E-53	1196935689	Furnace Filter 15.9" x 19" Metal	E-58
1006697	Furnace Filter Kit 17" x 28" Mc 29"	E-58	11CL410B	Metal Floor Register 4" x 10" Brown	E-56
110010	Duct Collar W/ Tabs 10"	E-34	11CL410W	Metal Floor Register 4" x 10" White	E-56
1101025	Flex Duct 10" x 25' R4.2	E-33	11CL412B	Metal Floor Register 4" x 12" Brown	E-56
110120	Duct Collar W/ Tabs 12"	E-34	11CL412W	Metal Floor Register 4" x 12" White	E-56
1101225	Flex Duct 12" x 25' .047 R4	E-33	11CL48B	Metal Floor Register 4" x 8" Brown	E-56
110140	Duct Collar W/ Tabs 14"	E-34	11CL48W	Metal Floor Register 4" x 8" White	E-56
1101425	Flex Duct 14" x 25' R4.2	E-33	13010001	Coil Cabinet E2/E3- KD	E-27
110225	Drawband 36" Length	E-34	13010002	Coil Cabinet- Louvered Grille Only	E-27
11050001	Furnace Filter 2 Pak 17" x 24" Trimmable	E-57	13010004	Dual Fuel Kit	E-28
111001	Thermostat-Cool Only	E-25, E-59	1829M4A	Coil-Revolve QC R410A A/C H/P	E-22
111002	Thermostat-Heat Only	E-25, E-59	1829S4A	Coil-Revolve SF R410A A/C H/P	E-20
111003	Thermostat-Heating/Cooling 5 Wire	E-25, E-59	1830S4A	Coil-Revolve SF R410A A/C H/P	E-20
111004	Thermostat-Digital Programable Heat Pump (2H1C)	E-25, E-61	1836S4A	Coil-Revolve SF R410A A/C H/P	E-20
111005	Thermostat Digital Non-Programmable T-Stat 2H/1	E-25, E-60	1837S4A	Coil-Revolve SF R410A A/C H/P	E-20
111006	Thermostat Digital Programmable T-Stat 1H/1C	E-25, E-60	18400001	Control Package For Adding AC/Hp W/4 Wire	E-28
111007	Thermostat Digital Non Programmable T-Stat 1H/1C	E-25, E-60	1844S4A	Coil-Revolve SF R410A A/C H/P	E-20
111010	Thermostat Digital Programmable T-Stat Multifunction	E-25, E-61	1845M4A	Coil-Revolve QC R410A A/C H/P	E-6, E-22
111020	Thermostat Outdoor/Single	E-56	1845S4A	Coil-Revolve SF R410A A/C H/P	E-12, E-14, E-20
11110611	Furnace Filter Tech Fabric Blue 16" x 20" Washable	E-57	1847M4A	Coil-Revolve QC R410A A/C H/P	E-6, E-22
11121010	Metal Wye 12" x 10" x 10"	E-34	1847S4A	Coil-Revolve SF R410A A/C H/P	E-4, E-12, E-14, E-20
1112108	Reducer Inceaser 12"-10"	E-34	1851S4A	Coil-Revolve SF R410A A/C H/P	E-20
11121212	Metal Wye 12" x 12" x 12"	E-33, E-34	1854S4A	Coil-Revolve SF R410A A/C H/P	E-20
111220BRN	Grille Only	E-33	1855S4A	Coil-Revolve SF R410A A/C H/P	E-20
1113038	Pipe Hanger Strap Plastic, 3/4" x 100', .050 Gauge Roll	D-9, E-34, I-2	1856S4A	Coil-Revolve SF R410A A/C H/P	E-12
111412	Metal Wye 14" x 12" x 12"	E-34	187848MA	Coil-Revolve QC R410A A/C H/P	E-22
1114128	Reducer Inceaser 14"-12"	E-34	187848S4A	Coil-Revolve SF R410A A/C H/P	E-12, E-14, E-20
11141414	Metal Wye 14" x 14" x 14"	E-34	1888120854D	Blower-Nordyne Electric E2EH-E2EB 4 -4.5 Ton	E-27
112012	Packaged Systems Accessory Kit	E-33	1899911101	Revolve Coil Universal Drain Pan	E-20, E-22
1122515	Furnace Filter 16" x 20" Fiberglass	E-58	18R72DB0003	TXV Kit R410A Revolve	E-22
1122517	Furnace Filter 20" x 20" Fiberglass	E-58	18R72DB0004	TXV Kit R410A Revolve	E-22
1124242D	Pad A/C 24 x 24 x 2"	E-56	18R72DB003	TXV Kit R410A Revolve	E-20
1124243D	Pad A/C 24 x 24 x 3"	E-56	18R72DB004	TXV Kit R410A Revolve	E-20
1130302D	Pad A/C 30 x 30 x 2"	E-56	20D4	Harbour Crest Double 4"	B-27
1130303D	Pad A/C 30 x 30 x 3"	E-56	20D5	Harbour Crest Double 5"	B-28
1132323D	Pad A/C 32 x 32 x 3"	E-56	20DL4	Harbour Crest 4" Dutchlap	B-26
1134342D	Pad A/C 34 x 34 x 2"	E-56	20DL45	Harbour Crest 4.5" Dutchlap	B-27

## INDEX BY PART NUMBER

20DL5 _____	Harbour Crest 5" Dutchlap . . . . .	B-28	32US10SD02	Universal Soffit Vinyl Solid Soffit 10" . . . . .	B-44
20T333 _____	Harbour Crest Triple 3.3" . . . . .	B-29	32US10VT02	Universal Soffit Vinyl Vented Soffit 10" . . . . .	B-44
21SS696SD02	T2-6" Beaded-Solid Porch Ceiling Panel . . . . .	B-41	32US12BW02	Universal Soffit Vinyl Soffit/Basket Weave Vented 12" . . . . .	B-45
21SS696VT02	T2-6" Beaded-Vented Porch Ceiling Panel . . . . .	B-42	32US12CV02	Universal Soffit Vinyl Center Vented Soffit 12" . . . . .	B-45
\2310004208	Novik Hand-Cut Stone Panel Canyon Blend . . . . .	B-19	32US12SD02	Universal Soffit Vinyl Solid Soffit 12" . . . . .	B-45
2310004209	Novik Hand-Cut Stone Panel Desert Blend . . . . .	B-19	32US12VT02	Universal Soffit Vinyl Vented Soffit 12" . . . . .	B-45
2310004213	Novik Hand-Cut Stone Panel Bark Blend . . . . .	B-19	332011	Premium Plus Bulk White . . . . .	B-9
2310005204	Novik Hand-Laid Brick Panel Red Used Blend . . . . .	B-18	332012	Premium Plus Bulk Chocolate . . . . .	B-9
2310005205	Novik Hand-Laid Brick Panel Brown Blend . . . . .	B-18	332013	Premium Plus Bulk Grey . . . . .	B-9
2310005214	Novik Hand-Laid Brick Panel Old Red Blend . . . . .	B-18	332014	Premium Plus Bulk Clay . . . . .	B-9, B-11
2310014217	Novik Sk Stacked Stone Panel Smoke Gray . . . . .	B-21	332017	Premium Plus Bulk Tan . . . . .	B-9
2310014218	Novik Sk Stacked Stone Panel Moka . . . . .	B-21	332018	Premium Plus Bulk Sand . . . . .	B-9
23100540002	Novik Ds Dry Stacked Stone Panel Basalt . . . . .	B-20	332019	Premium Plus Bulk Charcoal . . . . .	B-9
23100540004	Novik Ds Dry Stacked Stone Panel Brownstone . . . . .	B-20	332021	Premium Plus Bulk White . . . . .	B-9
23100540006	Novik Ds Dry Stacked Stone Panel Anthracite . . . . .	B-20	332022	Premium Plus Bulk Chocolate . . . . .	B-9
23100540008	Novik Ds Dry Stacked Stone Panel Limestone . . . . .	B-21	332023	Premium Plus Bulk Grey . . . . .	B-9
23120045208	Novik Hand-Cut Stone Corner Canyon Blend . . . . .	B-19	332024	Premium Plus Bulk Clay . . . . .	B-9, B-11
23120045209	Novik Hand-Cut Stone Corner Desert Blend . . . . .	B-19	332027	Premium Plus Bulk Tan . . . . .	B-9
23120045213	Novik Hand-Cut Stone Corner Bark Blend . . . . .	B-19	332028	Premium Plus Bulk Sand . . . . .	B-9
23120055204	Novik Hand-Laid Brick Corner Red Used Blend . . . . .	B-18	332029	Premium Plus Bulk Charcoal . . . . .	B-9
23120055205	Novik Hand-Laid Brick Corner Brown Blend . . . . .	B-18	332031	Premium Plus Bulk White . . . . .	B-9, B-15
23120055214	Novik Hand-Laid Brick Corner Old Red Blend . . . . .	B-18	332032	Premium Plus Bulk Chocolate* . . . . .	B-9, B-15
23120145217	Novik Sk Stacked Stone Corner Smoke Gray . . . . .	B-21	332033	Premium Plus Bulk Grey . . . . .	B-9, B-15
23120145218	Novik Sk Stacked Stone Corner Moka . . . . .	B-21	332034	Premium Plus Bulk Clay . . . . .	B-9, B-11, B-15
23120540002	Novik Ds Dry Stacked Stone Corner Basalt . . . . .	B-20	332037	Premium Plus Bulk Tan . . . . .	B-9, B-15
23120540004	Novik Ds Dry Stacked Stone Corner Brownstone . . . . .	B-20	332038	Premium Plus Bulk Sand . . . . .	B-9, B-15
23120540006	Novik Ds Dry Stacked Stone Corner Anthracite . . . . .	B-20	332039	Premium Plus Bulk Charcoal* . . . . .	B-9, B-15
23120540008	Novik DS Dry Stacked Stone Corner Limestone . . . . .	B-21	332061	Premium Plus Panel White . . . . .	B-9
27GB245 _____	Propride 4.5" Dutchlap . . . . .	B-49	332062	Premium Plus Panel Chocolate . . . . .	B-9
291824M	Access Door 18" x 24" Track Mount . . . . .	B-12, B-17	332063	Premium Plus Panel Grey . . . . .	B-9
291824S	Access Door 18" x 24" Flange Mount . . . . .	B-12, B-17	332064	Premium Plus Panel Clay . . . . .	B-9
292325S	K-Rok Panel 32" x 5' Panel Sandstone . . . . .	B-16	332067	Premium Plus Panel Tan . . . . .	B-9
292325T	K-Rok Panel 32" x 5' Panel Brown . . . . .	B-16	332068	Premium Plus Panel Sand . . . . .	B-9
292325Y	K-Rok Panel 32" x 5' Panel Granite . . . . .	B-16	332069	Premium Plus Panel Charcoal . . . . .	B-9
292365S	K-Rok Panel 36" x 5' Panel Sandstone . . . . .	B-16	332211	Premium Plus Panel White . . . . .	B-9
292365T	K-Rok Panel 36" x 5' Panel Brown . . . . .	B-16	332212	Premium Plus Trim Kit Chocolate . . . . .	B-9
292365Y	K-Rok Panel 36" x 5' Panel Granite . . . . .	B-16	332213	Premium Plus Trim Kit Grey . . . . .	B-9
292485S	K-Rok Panel 48" x 5' Panel Sandstone . . . . .	B-16	332214	Premium Plus Trim Kit Clay . . . . .	B-9, B-11
292485T	K-Rok Panel 48" x 5' Panel Brown . . . . .	B-16	332217	Premium Plus Trim Kit Tan . . . . .	B-9
292485Y	K-Rok Panel 48" x 5' Panel Granite . . . . .	B-16	332218	Premium Plus Trim Kit Sand . . . . .	B-9
292505S	Bottom Track Sandstone 10' . . . . .	B-16	332219	Premium Plus Trim Kit Charcoal . . . . .	B-9
292505T	Bottom Track Brown 10' . . . . .	B-16	333331	Premium Plus Center Vent White . . . . .	B-9
292505Y	Bottom Track Granite 10' . . . . .	B-16	333332	Premium Plus Center Vent Chocolate . . . . .	B-9
29255	Foundation Vent Insert Sandstone . . . . .	B-16	333333	Premium Plus Center Vent Grey . . . . .	B-9
293121592	Metal Stud 2½" x 12" x 25 Ga. . . . .	B-16	333334	Premium Plus Center Vent Clay . . . . .	B-9
293121593	Metal Stud 3 ¾" x 12" x 25 Ga. . . . .	B-16	333337	Premium Plus Center Vent Tan . . . . .	B-9
294941A	Duct Collar (12") . . . . .	E-30, E-32	333338	Premium Plus Center Vent Sand . . . . .	B-9
294942A	Duct Collar (14") . . . . .	E-30, E-32	333339	Premium Plus Center Vent Charcoal . . . . .	B-9
29901	Foundation Vent Insert Black . . . . .	B-16	33401	Jig . . . . .	B-13
29905	Foundation Vent Insert Sandstone . . . . .	B-16	33412	Wind Stay Rods 12" Length, 32 Bdl. . . . .	B-13
29907	K-Rok Panels Access Door 32" x 36" Brown . . . . .	B-16	33424	Wind Stay Rods 24" Length, 32 Bdl. . . . .	B-13
29909	K-Rok Panel Access Door 32" x 36" Granite . . . . .	B-16	3343779	Skirt Hang'r Metal Skirting Bracket . . . . .	B-13
2995	Foundation Vent Insert Black . . . . .	B-16	3350	Spikes 100 - 8" & Nails 200 1 ½" . . . . .	B-13
29955	K-Rok Panel Access Door 32" x 36" Sandstone . . . . .	B-16	3352	Nails 1 ½" . . . . .	B-13
2996	Foundation Vent Automatic - Brown . . . . .	B-17	3354	Spikes 100 - 8" & Screws 200 #8 . . . . .	B-13
2997	Foundation Vent Automatic - Black . . . . .	B-17	343011	Eagle Deluxe Bulk White . . . . .	B-11
30120	Wedge Hrdwd 2" x 4" x 8" P/T 80/Bag . . . . .	D-8	343013	Eagle Deluxe Bulk Grey . . . . .	B-11
30122	Board Hrdwd 1" x 8" x 16 "Treated 10/Bdl . . . . .	D-8	343017	Eagle Deluxe Bulk Tan . . . . .	B-11
30124	Board Hrdwd 2" x 8" x 16 "Treated 10/Bdl . . . . .	D-8	343018	Eagle Deluxe Bulk Sand . . . . .	B-11
30125	Wedge Hrdwd 1" x 4" x 7" N/T 40/Bag . . . . .	D-8	343021	Eagle Deluxe Bulk White . . . . .	B-11
32DS10SD _____	Vinyl Soffit 10" . . . . .	B-40	343023	Eagle Deluxe Bulk Grey . . . . .	B-11
32DS10VT _____	Vinyl Soffit 10" Vented . . . . .	B-40	343027	Eagle Deluxe Bulk Tan . . . . .	B-11
32DS12CV _____	Vinyl Soffit Center Vented 12" . . . . .	B-41	343028	Eagle Deluxe Bulk Sand . . . . .	B-11
32DS12SD _____	Vinyl Soffit 12" Solid . . . . .	B-40	343051	Eagle Deluxe White . . . . .	B-11
32DS12VT _____	Vinyl Soffit Vented 12" . . . . .	B-41	343053	Eagle Deluxe Grey . . . . .	B-11

## INDEX BY PART NUMBER

343057	Eagle Deluxe Tan	B-11	39VNB1260__OL	Shutter - Traditional Open Louver 12"	B-47
343058	Eagle Deluxe Sand	B-11	39VNB1260__RP	Shutter - Colonial Raised Panel 12"	B-47
343081	Eagle Panel White	B-11	39VNB1264__OL	Shutter - Traditional Open Louver 12"	B-47
343083	Eagle Panel Grey	B-11	39VNB1264__RP	Shutter - Colonial Raised Panel 12"	B-47
343084	Eagle Panel Clay	B-11	39VNB1267__OL	Shutter - Traditional Open Louver 12"	B-47
343087	Eagle Panel Tan	B-11	39VNB1267__RP	Shutter - Colonial Raised Panel 12"	B-47
343088	Eagle Panel Sand	B-11			
343251	Eagle Deluxe Trim Kit White	B-11	39VNB1271__OL	Shutter - Traditional Open Louver 12"	B-47
343253	Eagle Deluxe Trim Kit Grey	B-11	39VNB1271__RP	Shutter - Colonial Raised Panel 12"	B-47
343257	Eagle Deluxe Trim Kit Tan	B-11	39VNB1528__OL	Shutter - Traditional Open Louver 14"	B-47
343258	Eagle Deluxe Trim Kit Sand	B-11	39VNB1528__RP	Shutter - Colonial Raised Panel 14 ¾"	B-47
349991	Eagle Center Vent White	B-11	39VNB1531__OL	Shutter - Traditional Open Louver 14"	B-47
349993	Eagle Center Vent Grey	B-11	39VNB1531__RP	Shutter - Colonial Raised Panel 14 ¾"	B-47
349994	Eagle Center Vent Clay	B-11	39VNB1535__OL	Shutter - Traditional Open Louver 14"	B-47
349997	Eagle Center Vent Tan	B-11	39VNB1535__RP	Shutter - Colonial Raised Panel 14 ¾"	B-47
349998	Eagle Center Vent Sand	B-11	39VNB1539__OL	Shutter - Traditional Open Louver 14"	B-47
3500.5821	Control Package For Adding AC/HP W/2 Wire (Heat Only)	E-28	39VNB1539__RP	Shutter - Colonial Raised Panel 14 ¾"	B-47
3500.5841	Control Package For Adding AC/HP W/4 Wire (Heat/Cool)	E-28	39VNB1543__OL	Shutter - Traditional Open Louver 14"	B-47
3500.6901	Blower-Revolv Electric 2-4 Tons	E-27	39VNB1543__RP	Shutter - Colonial Raised Panel 14 ¾"	B-47
3500.7901	Blower-Revolv Electric 4+ Tons	E-27	39VNB1547__OL	Shutter - Traditional Open Louver 14"	B-47
3510	Ground Spikes 8"	B-13	39VNB1547__RP	Shutter - Colonial Raised Panel 14 ¾"	B-47
394717	Flex "J" ¾" Opening	B-34	39VNB1551__OL	Shutter - Traditional Open Louver 14"	B-47
39AC300	Outside Corner Post 3"	B-31	39VNB1551__RP	Shutter - Colonial Raised Panel 14 ¾"	B-47
39AC31102	J-Casing Wide	B-37	39VNB1555__OL	Shutter - Traditional Open Louver 14"	B-47
39AC322	Finish Trim ¾" Face	B-32	39VNB1555__RP	Shutter - Colonial Raised Panel 14 ¾"	B-47
39AC325	Inside Corner Post	B-32	39VNB1560__OL	Shutter - Traditional Open Louver 14"	B-47
39AC333	J-Channel ¾"	B-30	39VNB1560__RP	Shutter - Colonial Raised Panel 14 ¾"	B-47
39AC344	Frieze Runner "F" Channel	B-33	39VNB1564__OL	Shutter - Traditional Open Louver 14"	B-47
39AC355	J-Channel ½"	B-30	39VNB1564__RP	Shutter - Colonial Raised Panel 14 ¾"	B-47
39AC37702	T-Channel ¾"	B-34	39VNB1567__OL	Shutter - Traditional Open Louver 14"	B-47
39AC388	J-Channel ¾"	B-29	39VNB1567__RP	Shutter - Colonial Raised Panel 14 ¾"	B-47
39AC39902	Transition Molding	B-37	39VNB1571__OL	Shutter - Traditional Open Louver 14"	B-47
39AC566	J-Channel ¾"	B-30	39VNB1571__RP	Shutter - Colonial Raised Panel 14 ¾"	B-47
39AD400	Outside Corner 4"	B-31	39VSTR	Vinyl Starter Strip	B-37
39AD412	Outside Corner 4"	B-31	39WM1202	Window/Door Molding	B-35
39BC30002	Bay Corner 3"	B-32	39WM802	Window/Door Molding	B-34
39CM02	Crown Molding Front "F"	B-35	39WW35	Face Window Lineal 3 ½"	B-38
39CMB02	Crown Molding Retainer	B-36	39WW35F	Face Window Lineal 3 ½"	B-39
39CMBF02	Crown Molding Back "F"	B-36	39WW50	Window Lineal 5" Face	B-39
39CMFT02	Crown Molding Front	B-35	39WW50F	Window Lineal Foam Insert	B-39
39FC61202	Vinyl Fascia 6 ½"	B-38	39Z13	Perrenia Standard Mount	B-48
39FC73402	Vinyl Fascia 7 ¾"	B-38	39Z15	Perrenia Recessed Split Mount	B-548
39S24	Trim Coil 24" Smooth	B-42	39Z43	Perrenia Mini Mount	B-48
39S24PVC	Pvc Trim Coil 24"	B-42	39ZE	Perrenia Exhaust Vent Kit	B-48
39STR	Aluminum Starter Strip	B-36	42143	Chip Brush 3"	L-6
39T1202	T-Channel ½"	B-33	426625	Kool Seal Elastomeric Finish Coat 4.75 Gal.	L-1
39T3802	T-Channel ¾"	B-33	426645	Kool Seal Premium Fibered Aluminum Roof Coat	
39TC	Trim Coil 24" Smooth	B-43		4.75 Gal. Premium	L-1
39TCV	Pvc Trim Coil 24" Striated Pvc Finish	B-43	426655	Kool Seal Premium Elastomeric Finish Coat	
39VNB1228__OL	Shutter - Traditional Open Louver 12"	B-47		4.75 Gal. Roof Coating	L-1
39VNB1228__RP	Shutter - Colonial Raised Panel 12"	B-47	426675	Kool Seal Fibered Aluminum Roof Coat 4.75 Gal.	L-2
39VNB1231__OL	Shutter - Traditional Open Louver 12"	B-47	426821	Kool Seal Premium Elastomeric Finish Coat .9 Gal. Roof Coating	L-1
39VNB1231__RP	Shutter - Colonial Raised Panel 12"	B-47	426841	Kool Seal Premium Fibered Aluminum Roof Coat .9 Gal. Premium L-1	
39VNB1235__OL	Shutter - Traditional Open Louver 12"	B-47	426871	Kool Seal Fibered Aluminum Roof Coat .9 Gal.	L-2
39VNB1235__RP	Shutter - Colonial Raised Panel 12"	B-47	42972	Roof Coat Wooden Brush 4 ¾"	L-6
39VNB1239__OL	Shutter - Traditional Open Louver 12"	B-47	42989	Roof Coat Wooden Handle 48"	L-6
39VNB1239__RP	Shutter - Colonial Raised Panel 12"	B-47	431017	Subfloor & Construction Adhesive - 10.5 Oz. 12/Box	L-3
39VNB1243__OL	Shutter - Traditional Open Louver 12"	B-47	43120334	Putty Tape ⅞" x ¾" x 30'	H-62, L-4
39VNB1243__RP	Shutter - Colonial Raised Panel 12"	B-47	43120410	Putty Tape ⅞" x 1" x 30'	H-62, L-4
39VNB1247__OL	Shutter - Traditional Open Louver 12"	B-47	43120615	Putty Tape ⅞" x 1 ½" x 30'	H-62, L-4
39VNB1247__RP	Shutter - Colonial Raised Panel 12"	B-47	431651011	Roof Cement, Plastic, Wet / Dry Surface 11 Oz.	L-3
39VNB1251__OL	Shutter - Traditional Open Louver 12"	B-47	431651128	Roof Cement Coat .9 Gal.	L-2
39VNB1251__RP	Shutter - Colonial Raised Panel 12"	B-47	43169300	Silicone Sealants Clear Caulk 10.2 Oz.	L-3
39VNB1255__OL	Shutter - Traditional Open Louver 12"	B-47	43169302	Silicone Sealant White Caulk 10.2 Oz.	L-3
39VNB1255__RP	Shutter - Colonial Raised Panel 12"	B-47	43169402	Acrylic Caulk 10.2 Oz. White	L-3

# INDEX BY PART NUMBER

43169702	Butyl Seal Caulk 10.3 Oz. White	L-3	481445G	Concrete Anchors "J" Hook Swivel Head Galvanized	D-2
43306	Caulk All Purpose 6 Oz.	L-3	481592	EZ Anchor® Mm Belled Anchors 30" x 3/4" Shaft W/2"-4"	D-2
433312	Peel N' Seal Silver 12" x 33.5'	L-4	481593	EZ Anchor® Mm Belled Anchors 36" x 3/4" Shaft W/6"-4"	D-2
433336	Peel N' Seal Silver 36" x 33.5'	L-4	481822	Storage Building Anchor Kit 15" Anchor Length	D-10
43334	Peel N' Seal Silver 4" x 33.5'	L-4	482010	Slotted Split Bolt/Nut	D-3
43336	Peel N' Seal Silver 6" x 33.5'	L-4	482202G	Stabilizer Plate Galvanized 17.5"	D-6
433824	Spray Adhesive 16 Ounce Can	L-5	48233	Stabilizer Plate Painted 12" x 11 1/4" x 8 gauge	D-6
436024	Construction Adhesive All Purpose	L-3	482388	Concrete Anchors Double Tension Head Galvanized	D-2
436030	Construction Adhesive All Purpose Low VOC	L-3	482741	Anchor Drive Machine Drive Head Adapter	D-7, K-3
436121	Kool Seal Acrylic Patching Cement .9 Gal.	L-2	482822	Tie 4-Bolt Longitudinal Frame	D-5
43RCD52	Spray Adhesive 16 Ounce Can	L-5	483510	Longitude Beam Clip	D-5
445000	Anti-Freeze For Full Strength Usage - 1 Gallon	I-1	483521	Steel Pier Pad W/16" Pins Galvanized	D-13
44501	Blowout Plug - Plastic	I-1, K-4	483532N	Lateral Brace Tube W/Hardware 60" Adj. - Galvanized	D-13
44503	Antifreeze Hand Pump	I-1, K-4	483636	Concrete Anchors "J" Hook Non Swivel Painted	D-2
4463Q1531	Lineset-QC R410A 15'-3/8" x 3/4"-3.	E-9	483639	Longitudinal Flex Tube Galvanized 39" For Piers Up To 24"	D-14
4463Q2031	Lineset-QC R410A 20'-3/8" x 3/4"-3.	E-9	483644	Longitudinal Flex Tube Galvanized 44" For Piers Up To 32"	D-14
4463Q2531	Lineset-QC R410A 25'-3/8" x 3/4"-3.	E-9	48364634M	Painted Twin Disk Anchors 36" x 3/4" W/1-4" & 1-6" Helix	D-1
4463Q3031	Lineset-QC R410A 30'-3/8" x 3/4"-3.	E-9	483653	Longitudinal Flex Tube Galvanized 53" For Piers Up To 40"	D-14
4463Q4031	Lineset-QC R410A 40'-3/8" x 3/4"-3.	E-9	483665	Longitudinal Flex Tube Galvanized 65" For Piers Up To 48"	D-14
4463Q5031	Lineset-QC R410A 50'-3/8" x 3/4"-3.	E-9	483739	Longitudinal Brace Tube W/Beam Clip Galvanized 39"	
4473Q1531	Lineset-QC R410A 15'-3/8" x 7/8"-3.	E-9		For Piers Up To 24"	D-13
4473Q2031	Lineset-QC R410A 20'-3/8" x 7/8"-3.	E-9	483744	Longitudinal Brace Tube W/Beam Clip Galvanized 44"	
4473Q2531	Lineset-QC R410A 25'-3/8" x 7/8"-3.	E-9		For Piers Up To 32"	D-13
4473Q3031	Lineset-QC R410A 30'-3/8" x 7/8"-3.	E-9	483753	Longitudinal Brace Tube W/Beam Clip Galvanized 53"	
4473Q4031	Lineset-QC R410A 40'-3/8" x 7/8"-3.	E-9		For Piers Up To 40"	D-13
4473Q5031	Lineset-QC R410A 50'-3/8" x 7/8"-3.	E-9	483765	Longitudinal Brace Tube W/Beam Clip Galvanized 65"	
4563Q1101	Stub Kit-Indoor 3/8" x 3/4"	E-10		For Piers Up To 48"	D-13
4563Q1201	Stub Kit-Combo 3/8" x 3/4"	E-10	485056G	Eye Anchors 30" x 1/2" Rod, 4" Helix	D-10
4563Q2201	Stub Kit Outdoor 3/8" x 3/4"	E-10	4859003	Beam Clamp W/ Bolt And Nut 3"	D-5
4573Q1101	Stub Kit-Indoor 3/8" x 7/8"	E-10	4859004	Beam Clamp w/ Bolt And Nut 4"	D-5
4573Q1201	Stub Kit-Combo 3/8" x 7/8"	E-10	4859005	Double Beam Clamp W/ Bolt And Nut	D-5
4573Q2201	Stub Kit-Outdoor 3/8" x 7/8"	E-10	4859009	Frame Bracket Angled W/Bolts And Nuts - 24 Per Box	D-5
48101014	Strap Seal For 1 1/4" Strap	D-4	4859011	Clamp Gator Beam 8 Bolt	D-5
48101100	Frame Hook Only-50/ Carton	D-4	4859012	Strut For Longitudinal Systems 30" L Pier Height	
48101200	Double Slot Strap Buckle Only	D-4		Up To 2 Blocks	D-16, D-18
48102100	Straps 1 1/4" x 600' G60 - Galvanized	D-3	4859013	Strut For Longitudinal Systems 39" L Pier Height	
48102106	Frame Hook W/ 6' Strap	D-3		Up To 3 Blocks	D-16, D-18
48102107	Frame Hook W/ 7' Strap	D-3	4859014	Strut For Longitudinal Systems 44" L Pier Height	
48102108	Frame Hook W/ 8' Strap	D-3		Up To 4 Blocks	D-16, D-18
48102110	Frame Hook W/ 10' Strap	D-3	4859015	Strut For Longitudinal Systems 53" L Pier Height	
48102112	Frame Hook W/ 12' Strap	D-3		Up To 5 Blocks	D-16, D-18
48102114	Frame Hook W/ 14' Strap	D-3	4859016	Vector System 3 Sq. Ft. Pad Longitudinal	D-16, D-18
48102116	Frame Hook W/ 16' Strap	D-3	4859018	Vector System For Lateral Stabilization Block Pads	D-15
48102118	Frame Hook W/ 8' Strap	D-3	4859023	Vector System Longitudinal Stabilization Hardware Kit	D-16
48102206	Double Slot Buckle W/ 6' Strap	D-3	4859024	Vector Lateral Hardware Kit (Florida)	D-15
48102207	Double Slot Buckle W/ 7' Strap	D-3	4859026	Vector System 3 Sq. Ft. Pad	D-16
48102208	Double Slot Buckle W/ 8' Strap	D-3	4859036	Vector System For Lateral Stabilization	
48102210	Double Slot Buckle W/ 10' Strap	D-3		For Concrete (Single Block)	D-15
48102214	Double Slot Buckle W/ 14' Strap	D-3	4859049	Vector System For Lateral Stabilization	
48102370	Straps 1 1/4" x 37' G60 - Galvanized	D-3		For Concrete (Double Block)	D-15
48102375	Straps 1 1/4" x 37' G120 - Galvanized	D-3	4859092	Deep-Set Tie Down Anchors Anchor Deep Set 36" x 3/4"	D-2
48102505	Swivel Strap Con. W/5' Strap	D-3	4859145	Roof Bracket Heavy Duty - Galvanized	D-4
48102506	Swivel Strap Con. W/6' Strap	D-3	4859200	Soil Test Probe W/ Carrying Case & Torque Wrench	
48102507	Swivel Strap Con. W/7' Strap	D-3		Instruction	D-7, K-3
48102508	Swivel Strap Con. W/8' Strap	D-3	4859206	Universal Quick Assembly With 6' Strap	D-3
48102512	Swivel Strap Con. W/12' Strap	D-3	4859208	Universal Quick Assembly With 8' Strap	D-3
48102600	Straps 1 1/4" x 600' G120 - Galvanized	D-3	4859226	Anchor Drive Machine 1/2 HP Drive Machine	D-7, K-3
481061	Concrete Anchors Bolt Anchor Concrete 3/8" x 3"	D-2	4859263	XI2 Concrete Foundation System Hardware Kit Concrete System	D-18
481271G	Twin Disk Anchors 30" x 3/4" Shaft W/Twin 4" Helix - Galvanized	D-1	4859271	Vector System 3 Sq. Ft. Pad	D-15
481278	Coral Mobile Home Specialty Anchor 36" x 5/8" W/3	D-2	4859291	Stabilizer Plate 4	D-5
481346G	Twin Disk Anchors 36" x 3/4" Shaft		4859293	Stabilizer Plate Plastic	D-6
	W/1-4", 1-6" Helix - Galvanized	D-1	4859306	Strut For Longitudinal Systems 65" L Pier Height Up To 6 Blocks	D-17
481360	Cross "x" Drive Head Only	D-2	4859307	Longitudinal Hardware Kit	D-18
481380	Cross "x" Drive Rods Only 30" x 3/4" 8/Bundle	D-2	4859314	XI Steel Pier With Longitudinal System For 12" Height	D-18
481445	Concrete Anchors "J" Hook Swivel Head Painted	D-2	4859317	XI Steel Pier With Longitudinal System For 25.5" Height	D-18

## INDEX BY PART NUMBER

4859321	Longitudinal Struts For "Concrete Systems" 65" L Pier Height Up To 6 Blocks . . . . .	D-18	5006880	Straight Valve ½" Straight Valve Poly / Pex . . . . .	J-35
4859328	xi2 Concrete Foundation System "Dry Set" Concrete System . . . . .	D-18	50080	Strainer Adapter 1 ½" x 1" SWVL . . . . .	J-20
4859330-10	xi2 Ground Foundation System . . . . .	D-17	50100001	Tuff-Pex Tubing ½" x 100' Blue . . . . .	J-37
4859330-39	Longitudinal Struts For "Ground Systems" 30" L Pier Height Up To 2 Blocks . . . . .	D-17	50100002	Tuff-Pex Tubing ½" x 100' Red . . . . .	J-37
4859330-44	Longitudinal Struts For "Ground Systems" 39" L Pier Height Up To 3 Blocks . . . . .	D-17	50100003	Tuff-Pex Tubing ¾" x 100' Blue . . . . .	J-37
4859330-53	Longitudinal Struts For "Ground Systems" 44" L Pier Height Up To 4 Blocks . . . . .	D-17	50100004	Tuff-Pex Tubing ¾" x 100' Red . . . . .	J-37
4859330-65	Longitudinal Struts For "Ground Systems" 53" L Pier Height Up To 5 Blocks . . . . .	D-17	501001	Nut/Ring/Cone Set For ¼" Nominal Tube . . . . .	J-39
4859331	Longitudinal Struts For "Ground Systems" 65" L Pier Height Up To 6 Blocks . . . . .	D-18	501002	Nut/Ring/Cone Set ½" Thread For ¾" Nominal Tube Size . . . . .	J-39
4859345	xi Steel Pier With Longitudinal System For 36" Height . . . . .	D-18	501003	Nut/Ring/Cone Set ¾" Thread For ½" Nominal . . . . .	J-39
4859348	xi Lateral Stabilization Struts Lateral Strut, 5' W/Hardware . . . . .	D-18	501004	Nut/Ring/Cone Set 1" Thread For ¾" . . . . .	J-39
485963	xi2 Concrete Foundation System "Wet Set" Concrete System . . . . .	D-18	501010	Couplings/Nipples ½" MPT . . . . .	J-40
486001	Concrete Anchors Double Tension Head painted . . . . .	D-2	501011	Couplings/Nipples ¾" MPT x ½" MPT . . . . .	J-40
486012M	Painted Twin Disk Anchors 30" x ¾" W/Twin 4 Helix . . . . .	D-1	501012	Adapter ¾" MPT x ½" FPT . . . . .	J-40
486013G	Anchors Single Disk 48" Long x ⅝" Rod W/6" Helix - Galvanized . . . . .	D-1	501013	Couplings/Nipples ¾" MPT . . . . .	J-40
486030G	Anchors Single Disk 48" Long x ¾" Rod W/6" Helix - Galvanized . . . . .	D-1	501014	Couplings/Nipples 1" MPT x ¾" MPT . . . . .	J-40
486050G	Anchors Single Disk 24" Long x ⅝" Rod W/6" - Galvanized . . . . .	D-1	501015	Adapter 1" MPT x ¾" FPT . . . . .	J-40
487415	Eye Anchors 15" x ½" Rod, 4" Helix . . . . .	D-10	501016	Couplings/Nipples 1" MPT . . . . .	J-40
487430	Eye Anchors 30" x ½" Rod, 4" Helix . . . . .	D-10	501018	Female Elbow ¾" MPT x ½" FPT . . . . .	J-40
487648C	Eye Anchors 48" x ¾" Rod, 6" Helix . . . . .	D-10	501019	Elbow ½" MPT . . . . .	J-39
49315104	ABS Foamcore Pipe 1 ½" x 10' . . . . .	I-3	501020	Elbow ¾" MPT . . . . .	J-39
4932104	ABS Foamcore Pipe 2" x 10' . . . . .	I-3	501021	Elbow 1" x ¾" MPT . . . . .	J-39
4933104	ABS Foamcore Pipe 3" x 10' . . . . .	I-3	501022	Elbow 1" MPT . . . . .	J-39
4933204	ABS Foamcore Pipe 3" x 20' . . . . .	I-3	501023	Street Elbow ½" MPT x ½" FPT . . . . .	J-40
4963104	Schedule 40 PVC Pipe 3" x 10', 260 Psi, Belled End . . . . .	I-3	501024	Tee ½" MPT . . . . .	J-39
4963420	Schedule 40 PVC Rigid Pipe ¾" x 20', Belled End . . . . .	I-3	501025	Tee ¾" x ½" x ¾" MPT . . . . .	J-39
500007	PVC ¾" Ball Valve . . . . .	I-2	501026	Tee ¾" MPT . . . . .	J-39
500540	Flexible Transition Couplings . . . . .	I-6	501027	Tee 1" x ¾" x ¾" MPT . . . . .	J-39
5005834	Ice Maker Tee W/Valve . . . . .	J-34	501028	Tee 1" x 1" x ¾" MPT . . . . .	J-39
5006792	Adapter Pex Fitting ¾" x ¾" . . . . .	J-33	501029	Tee 1" MPT . . . . .	J-39
5006800	Elbows ½" P x ½" P Poly / Pex . . . . .	J-34	501044	Rain-R-Shine PVC Cement Rain-R-Shine ¼ Pint . . . . .	I-9
5006801	Drop Ear Elbow ½" x ½" Poly / Pex . . . . .	J-33	50104425	Male Pipe Adapters Brass ½" Pex x ½" MP . . . . .	J-37
5006803	Male Elbows ½" x ½" Poly / Pex . . . . .	J-34	501045	Rain-R-Shine PVC Cement Rain-R-Shine ½ Pint . . . . .	I-9
5006806	Elbows ¾" P x ¾" P Pex Only . . . . .	J-34	50104625	Male Pipe Adapters Brass ½" Pex x ¾" MP . . . . .	J-37
5006807	Swivel Elbows ¾" x ¾" F Swivel Pex . . . . .	J-33	50106425	Male Pipe Adapters Brass ¾" Pex x ½" MP . . . . .	J-37
5006810	Male Elbows ½" x ⅝" Poly / Pex . . . . .	J-34	50106625	Male Pipe Adapters Brass ¾" Pex x ¾" MP . . . . .	J-37
5006815	Elbows ⅝" P x ⅝" P Poly / Pex . . . . .	J-34	501122	Strainer Adapter 1 ½" x 2" SWVL . . . . .	J-20
5006816	Swivel Elbows ½" x ½" F Swivel Poly Pex . . . . .	J-33	5012020	Tuff-Pex Tubing ½" x 20' (½" Id ⅝" Od) . . . . .	J-37
5006817	Swivel Elbows ⅝" x ½" F Swivel Poly / Pex . . . . .	J-33	5012100	Tuff-Pex Tubing ½" x 100' (½" Id ⅝" Od) . . . . .	J-37
5006840	Coupling ½" P x ½" P Poly / Pex . . . . .	J-35	5014425	Coupler ½" x ½" 25 Bag . . . . .	J-38
5006841	Adapters - Female ½" x ½" F Poly / Pex . . . . .	J-34	5015411	Condensation Drain Trap ¾" . . . . .	E-55
5006842	Adapters - Male ½" x ½" M Poly / Pex . . . . .	J-34	5016625	Coupler ¾" x ¾" 25 Bag . . . . .	J-38
5006845	Coupling ½" x ¾" P Pex Only . . . . .	J-35	50184425	Adapter Coupling ½" x ½" . . . . .	J-38
5006846	Coupling ¾" P x ¾" Pex Only . . . . .	J-35	50186625	Adapter Coupling ¾" x ¾" . . . . .	J-38
5006847	Adapters - Female ¾" x ¾" F Pex Only . . . . .	J-34	50191093	Mansfield Tank Lever . . . . .	J-21
5006848	Adapters - Male ¾" x ¾" M Pex Only . . . . .	J-34	502000	Pipe Joint Compound 2 Oz Tube . . . . .	I-9
5006849	Swivel Straight Couplings ¾" P x ¾" FPT Pex Only . . . . .	J-35	502215	ABS P-Trap 1 ½" x 1 ½" . . . . .	I-5
5006853	Coupling ½" P x ⅝" Poly / Pex . . . . .	J-35	502220	ABS P-Trap 1 ½" x 1 ½" x ¼" . . . . .	I-5
5006855	Coupling ⅝" P x ⅝" Poly / Pex . . . . .	J-35	502260	Waste Outlet, Universal . . . . .	J-20
5006856	Swivel Straight Couplings ½" P x ¾" FPT Pex Only . . . . .	J-35	502267	Waste Outlet Universal, 16"-21" Telescopic . . . . .	J-19
5006858	Adapters - Female ½" x ¾" F Pex Only . . . . .	J-34	50246625	Female Pipe Adapter Brass ¾" Pex x ¾" SFP . . . . .	J-37
5006860	Cap ½" Pipe Cap Poly / Pex . . . . .	J-35	50254100	Copper Crimp Ring ½" Tubing Ring . . . . .	J-38
5006861	Cap ¾" Pipe Cap Poly / Pex . . . . .	J-35	50256100	Copper Crimp Rings ¾" Tubing Ring . . . . .	J-38
5006863	Plug ½" Pex Only . . . . .	J-35	5026206	Check Valve ¾" . . . . .	I-2
5006864	Plug ¾" Pex / Flair . . . . .	J-35	502634	Flush Valve 10 ¾" H With Ball & Chain . . . . .	J-21
5006865	Ballcock Adapters ½" x ¾" F Pex Only . . . . .	J-35	502740	Toilet Hold Down Fasteners W/Nuts ¼" x 2 ¼" . . . . .	J-21, K-4
5006869	Ballcock Adapters ⅝" x ¾" F Pex Only . . . . .	J-35	50275	Bowl Gasket Kit . . . . .	J-21
5006873	Swivel Straight Couplings ½" P x ½" FPT Poly / Pex . . . . .	J-35	502752	ABS Tees 1 ½" x 1 ½" x 1 ½" . . . . .	I-5
5006874	Swivel Straight Couplings ⅝" P x ½" FPT Poly / Pex . . . . .	J-35	502754	ABS Tees 3" x 3" x 3" . . . . .	I-5
5006879	Straight Valve ¾" Poly / Pex . . . . .	J-35	502824	ABS 45° Wye 3" x 3" x 3" . . . . .	I-5
			502837	ABS Long-Turn Tee Wyes 3" x 3" x 1 ½" . . . . .	I-5
			502852	ABS Long-Turn Tee Wyes 3" x 3" x 3" . . . . .	I-5
			502853	ABS Long-Turn Tee Wyes 1 ½" x 1 ½" x 1 ½" . . . . .	I-5
			502857	ABS Long-Turn Tee Wyes 3" x 3" x 2" . . . . .	I-5
			502858	ABS Long-Turn Tee Wyes 2" x 2" x 2" . . . . .	I-5
			502871	ABS 90° Elbows 1 ½" x 1 ½" . . . . .	I-5

# INDEX BY PART NUMBER

502873	ABS 90° Elbows 3" x 3"	I-5	50405	Ballcock Float Rod Brass 8"	J-21
502876	ABS 90° Elbows 1 1/2" x 1 1/2"	I-5	50406	Tank Lever - Standard Lever 8" Metal Arm, Plastic Spud	J-21
502878	ABS 90° Elbows 3" x 3"	I-5	50407	Mansfield Water Saver Flush Valve 10 3/4" H For	J-21
502882	ABS Elbows 3" x 3" 90°	I-5	50413	Kitchen Sink Tubular Tailpiece, 1 1/2" x 6" Brass Flanged, 22 Ga.	J-19
502885	ABS 45° Elbows 1 1/2" x 1 1/2"	I-5	50414	Bathroom Sink Tubular Tailpiece, 1 1/4" x 6"	J-19
502887	ABS 45° Elbows 3" x 3"	I-5	504408	PVC Coupling 3/4"	I-2
502892	ABS Elbows 3" x 3" 45°	I-5	504433	Swivel Elbow 1/2" Pex	J-37
502901	ABS 22-1/2° Elbow 3" x 3"	I-5	504449	Swivel Elbow 3/4" Pex	J-37
502903	ABS Closet Flange 4" x 3" - Hub	I-6	504505	PVC Elbow 90° 3/4"	I-2
502906	ABS Flush Bushing 2" x 1 1/2"	I-6	504933	Faucet Connection 1/2" x 1/2"	J-37
502922	ABS Fitting Clean Out Adapters 1 1/2" x 1 1/2"	I-5	504947	Pex Stop Valve 1/2"	J-37
502923	ABS Fitting Clean Out Adapters 2" x 2"	I-5	505212	Pipe Clamp Fits 1/2" - 1 1/4" Water Line	I-2, J-22
502924	ABS Fitting Clean Out Adapters 3" x 3"	I-5	50542	Flexible Transition Couplings	I-6
502933	ABS Couplings 1 1/2" x 1 1/2"	I-6	50543	Flexible Transition Couplings	I-6
502934	ABS Couplings 2" x 2"	I-6	50544	Flexible Transition Couplings	I-6
502935	ABS Couplings 3" x 3"	I-6	50545	Flexible Transition Couplings	I-6
502938	ABS Threaded Plugs 1 1/2"	I-6	505754	PVC Sanitary Tee 3"	I-7
502941	ABS Threaded Plugs 3"	I-6	505852	PVC Long Turn Tee Wye 3"	I-7
502975	ABS P-Trap Adapters 1 1/2" x 1 1/2"	I-6	505873	PVC 90° Long Turn Elbow 3" x 3"	I-7
50300001	Gasket For 501122	J-20	505878	PVC 90° Vent Elbow 3" x 3"	I-7
5030002	Pipe Swivels & Adapters 3/4" Hose x 3/4" Pipe Swivel	I-3	505882	PVC Elbows - Street 3" x 3", 90°	I-7
5034020	Tuff-Pex Tubing 3/4" x 20' (3/4" Id 7/8" od)	J-37	505887	PVC 45° Elbow 3"	I-7
503409	ABS P-Trap Adapters 1 1/2" x 1 1/4" W/Tube Stop & S/Washers	I-6	505901	PVC 22-1/2° Elbow 3"	I-7
5034100	Tuff-Pex Tubing 3/4" x 100' (3/4" Id 7/8" od)	J-37	505924	PVC Clean Out Adapter 3"	I-7
5034112	Pipe Clamp fits 3/4" - 1 1/2" Water Line	I-2, J-22	505935	PVC Coupling 3" x 3"	I-7
503419	ABS Tray Plug 1 1/2" SP x SPSM	I-5	505941	PVC Threaded Plug 3"	I-7
503492	Slip Joint Nut/Washer	J-20	506336343	ABS Closet Flange 4" x 3" - MPT	I-6
5035013516	Reducing Unions 1/2" x 3/8"	J-32	506336345	ABS Closet Flange 4" x 3" - FPT	I-6
5035100808	Female Connectors 3/8"	J-32	506432	Elbow 1/2" x 3/8" MPT - Dishwasher	J-39
5035101008	Female Connectors 1/2"	J-32	506441	Stop Valve 1/2" MPT x 1/2" MPT	J-40
5035101013	Female Connectors Closet 1/2"	J-32	506442	Stop Valve 3/4" MPT x 1/2" MPT	J-40
5035101412	Female Connectors 3/4"	J-32	506443	Elbow 1/2" x 3/4" MPT	J-39
5035141410	Reducing Stem 3/4" x 1/2"	J-32	50644425	Tee 1/2" x 1/2" x 1/2"	J-38
50351508	Union Connector 3/8"	J-31	506475	Ballcock Swivel 1/2" 3 Piece	J-38
50351510	Union Connector 1/2"	J-31	50664612	Tee 3/4" x 1/2" x 3/4"	J-38
50351514	Union Connector 3/4"	J-31	50666425	Tee 3/4" x 3/4" x 1/2"	J-38
5035151410	Reducing Unions 1/2" x 3/4"	J-32	50666625	Tee 3/4" x 3/4" x 3/4"	J-38
5035161004	Reducing Unions 1/2" x 1/4"	J-32	507051	PVC All Purpose Cement 1 Pint	I-9
50351710	Elbow 90° 1/2"	J-31	5070614	Cement 3-Way 1/4 Pint	I-9
50351714	Elbow 90° 3/4"	J-31	507070	Plastic Pipe PVC Cement Pint	I-9
50351810	Stackable Elbow 1/2"	J-31	507115	Cement 3-Way 1 Pint	I-9
5035191008	Male Elbow 1/2"	J-32	507120	Cement 3-Way 1 Quart	I-9
5035200808	Female Swivel Elbow 3/8"	J-31	507260	ABS Pipe Cement ABS Black 1/4 Pint	I-9
5035201008	Female Swivel Elbow 1/2"	J-31	507265	ABS Pipe Cement ABS Black 1/2 Pint	I-9
5035211008	Drop Ear Elbow 1/2"	J-31	507270	ABS Pipe Cement ABS Black 1 Pint	I-9
50352308	Union Tee 3/8"	J-31	507275	ABS Pipe Cement ABS Black 1 Quart	I-9
50352310	Union Tee 1/2"	J-31	5074425	Elbow 1/2" x 1/2"	J-37
50352314	Union Tee 3/4"	J-31	5076425	Elbow 3/4" x 1/2"	J-37
5035241004	Reducing Tee 1/2" x 1/4"	J-32	5076625	Elbow 3/4" x 3/4"	J-37
5035241410	Reducing Tee	J-32	508005	Plastic Pipe Primer - Cleaner	I-9
50353310	Stackable Tee 1/2"	J-32	508030	Cleaner All Purpose 1/4 PT.	I-9
50353314	Stackable Tee 3/4"	J-32	5081254	Ballcock Fluidmaster	J-20
50353908	Stop Valve 3/8"	J-31	508667	Lever, Fluidmaster	J-21
50353910	Stop Valve 1/2"	J-31	5094425	Female Pipe Adapters Brass 1/2" Pex x 1/2" FP	J-37
50353914	Stop Valve 3/4"	J-31	5096625	Female Pipe Adapters Brass 3/4" Pex x 3/4" FP	J-37
50354010	Union Check Valve 1/2"	J-31	5110133	Gate Valves 3/4" Regular Valve	I-4
50354510	End Stop 1/2"	J-32	5110153	Gate Valves Ips Nominal; Heavy Duty Size 3/4"	I-4
50354708	Collet Clip 3/8"	J-31	5110543	Swing Check Valve	I-3
50354710	Collet Clip 1/2"	J-31	5111702	Boiler Drain Valve 1/2" MIP x Hose	I-4
50354714	Collet Clip 3/4"	J-31	5111816	Frost-Free Silcock Valve 1/2" x 10"	I-4
5038100	Tuff-Pex Tubing 3/8" x 100' (3/8" Id 1/2" od)	J-37	5111850	Anti-Siphon Valve Connects To Any Hose Thread Break Off Bolt	I-3
50401	Ballcock W/ Water Level	J-20	51252074	Ball Valve 3/4" Ftp Brass	I-4
50402	Toilet Bolt Set 5/16" x 3"	J-21, K-4	5130217	Hose Bibb Valve Rough Brass	I-4
50403	Rubber Flapper Tank Ball W/Chain & Hook	J-21	518971	Boiler Drain Valve 3/4" MIP x Hose	I-4
50404	Toilet Tank Float Ball Black Plastic 4" x 5"	J-22	519444	In-Line Check Valve Brass, 3/4" Pipe	I-3

## INDEX BY PART NUMBER

5211959	Sewer Ring	I-6	53190009	Faucet Kitchen 8" Single Lever W/O Spray	J-25
5220002	Strainer Kitchen Sink 3 1/2" Twist Top Basket	J-19	53190010	Faucet Lavatory 4" Single Lever W/O Pop Up	J-27
5220003	Strainer Kitchen Sink Basket Only For 5220002	J-19	532010	Faucet Clear Handles 8" Goose Neck Spout	J-25
52200112	Gasket Needed For Bathtub Drain 52227	J-18	53201021	Toilet Seat Bone - Plastic	J-18
522005	Roof Cap 5" - 4 3/4" Above Roof Line	F-10	532011	Faucet Clear Handles, Drilled Less Pop-Up Assembly	J-27
522012	Shower Curtain Rod Aluminum, 60" W/Flange	J-17	532012	Faucet 8" D-Spout, Clear Handles And Aerator	J-25
522020	Pro-Vent With 1 1/2" MPT	J-18	532013	Faucet Clear Handles, Shower Head, Arm & Flange	J-26
522049	Vent Cap 1 1/2" Diameter	I-4	53202030	Toilet Seat White - Plastic	J-18
522084	Vent Caps 2 3/8" Diameter, Removable Cap	I-4	532038	Faucet High Rise Kitchen 8"	J-25
522086	Draft Cap 4" Flue Size	E-57	53204	Faucet Smoke Colored Handles, Shower Head, Arm & Flange	J-27
522095	Draft Cap 5" Flue Size	E-57	532077	Faucet Lavatory 4"	J-27
522109	Drain & Plug	J-18	532105	Plug PO Chrome 5"	J-19
522115	Sink Strainer Stainless Steel 4"	J-19	532112	Chrome C.O. Plug W/	J-18
52227	Bathtub Drain 1-1/2"	J-18	53271621	Toilet Complete White 1.28 GPF	J-20
5233R45	Shower Strainer 3 1/2"	J-18	5327501	Shower Door 28" x 65" Hinge	J-16
52381	Pipe Insulation 6' Id Size 1 1/8"	I-1	5327541L	Tub Standard White 27" x 54" LH	J-12
5238118	Pipe Insulation 6' Id Size 1 1/8"	I-1	5327541R	Tub Standard White 27" x 54" RH	J-12
523878	Pipe Insulation 6' Id Size 7/8"	I-1	5327542L	Tub Standard Almond 27" x 54" LH	J-12
524000	Wax Gasket	J-20	5327542R	Tub Standard Almond 27" x 54" RH	J-12
524005	Wax Gasket W/Flange	J-20	5327543C	Tub Heavy Duty White 27" x 54" Center Drain	J-12
53010001	Lavatory Sink 17" x 20"	J-18	5327544C	Tub Heavy Duty Almond 27" x 54" Center Drain	J-12
5302321	Shower Surround White 68"H x 32"W x 32"D	J-13	532754LHB	Permalux Standard Tubs Almond 27" x 54" / LH Drain	J-14
5302322	Shower Surround Almond 68"H x 32"W x 32"D	J-13	532754LHW	Permalux Standard Tubs White 27" x 54" / LH Drain	J-14
530258	Shower Arm 1/2" Short Arm	J-29	532754RHB	Permalux Standard Tubs Almond 27" x 54" / RH Drain	J-14
53111101-1	Tub 27" x 54" LH Drain Boxed-White - Aquatic	J-9	532754RHW	Permalux Standard Tubs White 27" x 54" / RH Drain	J-14
53111101-2	Tub 27" x 54" LH Drain Boxed-Almond - Aquatic	J-9	5330001L	Tub Heavy Duty White 27" x 54" LH	J-12
53111102-1	Tub 27" x 54" RH Drain Boxed-White - Aquatic	J-9	5330001R	Tub Heavy Duty White 27" x 54" RH	J-12
53111102-2	Tub 27" x 54" RH Drain Boxed-Almond - Aquatic	J-9	5330012L	Tub Heavy Duty Almond 27" x 54" LH	J-12
53111103-1	Tub 27" x 54" Center Drain Boxed-White - Aquatic	J-9	5330012R	Tub Heavy Duty Almond 27" x 54" RH	J-12
53111103-2	Tub 27" x 54" Center Drain Boxed-Almond - Aquatic	J-9	5330041	Tub Heavy Duty Garden White 40" x 54" W/Outside Step	J-12
53111104-1	Wall Kit 27" x 54" Boxed-White - Aquatic	J-9	5330042	Tub Heavy Duty Garden Almond 40" x 54" W/Outside Step	J-12
53111104-2	Wall Kit 27" x 54" Boxed-Almond - Aquatic	J-9	5330061	One Piece Surround White For 27" x 54" Tub	J-13
53111105-1	Shower Base 27" x 54" Boxed-White - Aquatic	J-9	5330062	One Piece Surround Almond For 27" x 54" Tub	J-13
53111105-2	Shower Base 27" x 54" Boxed-Almond - Aquatic	J-9	5330071	One Piece Surround White For 40" x 54" Garden Tub	J-13
53111107-1	Tub - Garden Tub 41" x 60" Center Drain Boxed-White - Aquatic	J-10	5330072	One Piece Surround Almond For 40" x 54" Garden Tub	J-13
53111107-2	Tub - Garden Tub 41" x 60" Center Drain Boxed -Almond - Aquatic	J-10	5330091	Shower Surround Three Piece White Panels For 40" x 54" Tub	J-13
53111108-1	Tub - Garden Tub 48" x 60" Center Drain Boxed-White - Aquatic	J-10	5330092	Shower Surround Three Piece Almond Panels For 40" x 54" Tub	J-13
53111108-2	Tub - Garden Tub 48" x 60" Center Drain Boxed -Almond - Aquatic	J-10	53301	Tub Trim Kit End Cap Left	J-17
53111109-3A	Shower Base Composite 32" x 32" A2 - White - Aquatic	J-11	5330101	Shower Surround Three Piece White Corner Caddy For 3 Piece Surround	J-13
53111109-3B	Shower Wall Back Composite 32" x 74" A2 - White - Aquatic	J-11	5330102	Shower Surround Three Piece Almond Corner Caddy For 3 Piece Surround	J-13
53111109-3C	Shower Wall Side Composite 32" x 74" A2 - White - Aquatic	J-11	53305	Tub Trim Kit End Cap Right	J-17
53111110-1	Tub - Garden Tub 41" x 54" Center Drain Boxed-White - Aquatic	J-10	53309	Inside Corner	J-17
53111110-2	Tub - Garden Tub 41" x 54" Center Drain Boxed -Almond - Aquatic	J-10	5331501	Shower Door 32" x 65" Hinge	J-16
53120	Tub Trim Kit Tub Molding Bar 120"	J-17	533161	Toilet Bowl White	J-20
53139	Rivets Almond	J-17	5332321	Shower Pan One Piece White 32" x 32"	J-13
53140	White Rivets	J-17	5332322	Shower Pan One Piece Almond 32" x 32"	J-13
531402	Faucet 4" Shower Only Concealed Riser	J-26	5332754A	Shower Surround Three Piece Almond Panels For 27" x 54" Tub	J-13
53162701	Lavatory Sinks Ivory, 16" x 20"	J-18	5332754W	Shower Surround White Panels For 27" x 54" Tub	J-13
5316270W	Lavatory Sinks White, 16" x 20"	J-18	533319	Kitchen Sink Double Stainless Steel 33" x 19" x 6" Depth	J-19
53163701	Lavatory Sink White W/Overflow	J-18	533320	Kitchen Sink Double Stainless Steel 33" x 19" x 7" Depth	J-19
53163702	Lavatory Sink Ivory W/Overflow	J-18	533321	Kitchen Sink Double Stainless Steel 33" x 19" x 8" Depth	J-19
5316370V	Lavatory Sink Ivory W/O-Overflow	J-18	5333970	Spout Garden Tub 1/2" Inlet	J-29
5316370W	Lavatory Sink White W/O-Overflow	J-18	5335428ALM	Shower Surround Almond 68"H x 54"W x 28"D	J-13
53172001	Lavatory Sink 17" x 20"	J-18	5335428W	Shower Surround White 68"H x 54"W x 28"D	J-13
53185	Tub Spout	J-28	53359C	Faucet Handle Cold - Metal Lever	J-29
53190001	Faucet Lavatory 4" W/O Pop Up	J-27	53359H	Faucet Handle Hot - Metal Lever	J-29
53190003	Faucet Lavatory SL With Pop Up	J-27	5339004	Plumbing Stem and Bonnet - Utopia Replacement	J-27
53190004	Faucet Lavatory 4" Nm Stem	J-27	534054B	Permalux Garden Tubs Almond 40" x 54" W/ Step	J-15
53190005	Faucet Kitchen 8" W/O Spray	J-25	534054W	Permalux Garden Tubs White 40" x 54" W/Step	J-15
53190006	Faucet Kitchen 8" With Spray	J-25	5340916C	Faucet Handle Cold Clear Acrylic	J-28
53190007	Faucet Kitchen 8" W/O Spray	J-25	5340916H	Faucet Handle Hot Clear Acrylic	J-28
53190008	Faucet Kitchen 8" Single Lever With Spray	J-25	534161	Toilet Tank White W/Acc.	J-20
			534260B	Permalux Garden Tubs Almond 42" x 60" W/O Step	J-15



## INDEX BY PART NUMBER

534260W	Permalux Garden Tubs White 42" x 60" W/O Step	J-15	55060012	Rapid Wall 12' Trim Back Rail Almond	B-24
534860	Tub Trim Kit Garden Tub Trim Kit	J-17	55060013	Rapid Wall 12' Trim Ground Rail-white	B-25
53493	Hose Washer ¾", Vinyl	J-19	55060014	Rapid Wall 12' Trim Ground Rail-grey	B-25
534964	Tub Trim Kit Reg. 54" Tub Trim Kit	J-17	55060015	Rapid Wall 12' Trim Ground Rail-almond	B-25
535232	Toilet Seat White - Wooden	J-18	55060019	Rapid Wall Undermount Trim Kit-Almond	B-25
5354010	Shower Door 54" x 57" Bypass	J-16	55060020	Rapid Wall Undermount Trim Kit-Grey	B-25
5354011	Shower Door 54" x 65" Bypass	J-16	55060021	Rapid Wall Undermount Trim Kit-White	B-25
535428ALH	Shower Pan One Piece Almond LH 54" x 28"	J-13	56010006	Water Heater Electric 30 Gallon	J-2
535428ARH	Shower Pan One Piece Almond RH 54" x 28"	J-13	56010007	Water Heater Electric 40 Gallon	J-4
535428WLH	Shower Pan One Piece White LH 54" x 28"	J-13	56010008++	Water Heater Electric 19 Gallon	J-2
535428WRH	Shower Pan One Piece White RH 54" x 28"	J-13	56010009	Water Heater Electric 28 Gallon	J-2
53582529	Toilet Complete White 1.6 GPF	J-20	56020006	Water Heater Gas 30 Gallon	J-4
5360013	Sink Rim Clamp	J-19	56020007	Water Heater Gas 40 Gallon	J-4
536010	Sprayer And Hose Metal	J-27	56020008	Water Heater Gas 30 Gallon	J-4
536012	Faucet 8" Plastic, Chrome Finish	J-27	56020009	Water Heater Gas 40 Gallon	J-4
536014	Flange	J-29	56030003	Outdoor Vent Extension 18"	J-4
536015	Tub Spout For 3 Valve; Diverter 8" Center	J-28	56030005	Roof Stack - WH Gas 12"	J-4
536016	Flange, 8" Center	J-28	56030006	Roof Stack - WH Gas 12"-32"	J-4
536029	Pop Up W/O Overflow	J-29	56030007	Roof Stack - WH Gas 32"-60"	J-4
5360299	Faucet Repair Kit 162 Piece	J-29	56030008	Roof Stack - WH Gas 60"-95"	J-4
536040	Center Diverter Stem	J-28	56030009	Air Inlet Kit - Direct Vent - Basement/Crawl	J-6
536049	Faucet Handle Clear, Arrow	J-28	570325	Dielectric Nipple ¾" MPT x ¾" MPT	J-8
5363712	Faucet Long Spout-Riser Outlet For Exposed Shower	J-25	5710471	Temperature Relief Valve Long Body	J-8
53638	Faucet Adjustable To 24" Centers, Acrylic Handles	J-26	572143	Immersion Element 120 volt 1500 watt Screw-In	J-8
536381	Renu Seat-Garden Tub #53638	J-28	572183	Element 120 volt 1750 watt	J-8
5363812	Faucet Long Spout For Concealed Shower	J-26	572283	Immersion Element 240 volt 3500 watt Screw-In	J-8
53638916HC	Handle Hot & Cold	J-29	57234	Backflow Preventer Stainless Steel Springs	I-3
536401	Renu Seat-Garden For All Exposed Fittings	J-28	572343	Immersion Element 240 volt 4500 watt Screw-In	J-8
5364050	Stem & Bonnet Assembly Exposed Fitting With Acrylic Handles (A)	J-28	577723	Thermostats Single Pole, Lower Element	J-8
			577843	Thermostats Single Pole Element W/HLC	J-8
5364712	Faucet Long Spout-Riser Outlet For Exposed Shower	J-26	577863	Thermostats Upper W/High Limit	J-8
5364812	Faucet Long Spout For Concealed Shower	J-26	579932	Socket Wrench Screw-In Element	J-8
536601	Renu Seat-Garden For All Concealed Fittings	J-28	5900873	Universal Receptacle	G-9
536603	Faucet For ⅞" Max. Wall Thickness, Abs Shower Head, Metal Arm Flange	J-26	59010001	Plastic Finial	F-5
			59010002	Globe Square Glass 12"	F-5
5366050	Stem & Bonnet Assembly Concealed Fittings (B)	J-28	59012301	Range Hood, Vented, White, 12" x 30"	G-6
536703	Faucet For ⅞" Max. Wall Thickness, Abs Shower Head, Metal Arm Flange	J-26	59023401	Ceiling Fixture Brushed Nickel 11" 2 light	F-4
			59024401	Ceiling Fixture Brushed Nickel 13" 2 Light	F-4
536801	Faucet Tub & Shower Head Arm & Flange 2" Shanks	J-26	590311	Fan Blade - Range Hood	G-7
536881	Faucet Shower Only W/ Arm & Flange 2" Shanks	J-26	590388	Bathroom Ceiling Fan Replacement Motor	F-9
53878	Drain Tip Toe W/Locknut	J-20	590409	Fan Blade - Range Hood Square Outlet	G-7
5392438	Shower Head ¾" Abs With C.P. Ring	J-28	590574	Bathroom Ceiling Fan Replacement Cover	F-9
5393412	Shower Head ½" Head With C.P. Ring	J-28	591013	Globe White 6"	F-1
53960108	Shower Arm ½" W/ Threaded Flange Kit	J-29	591052	Trim Ring 6"	G-8
53EB87	Regulating Valve	I-3	591054	Trim Ring Only 8"	G-8
53R15003	Faucet Kitchen With Spray 8" Center, Chrome	J-24	591056	Drip Pan Only 6"	G-8
53R38	Faucet Garden Tub Adjustable Centers, Chrome	J-24	591058	Drip Pan Only 8"	G-8
53R4003	Faucet Lavatory Less Pop-Up 4" Center, Chrome	J-24	591070	Range Hood Filter Grease 8" x 8"	G-6
53R5003	Faucet Kitchen W/O Spray 8" Center, Chrome	J-24	591111	Outside Vent Cover	G-7
53R801	Faucet Tub/Shower, Diverter 8" Center	J-24	59112301	Power Range Hood White, 115 volt, 12" x 30"	G-5
5416525	Fiberglass Pipe Insulation	I-1	5911501	Globe Plastic Diffuser 14"	F-5
542102	Heat Cable 100' Reel	I-1	591190	Exterior Fixture Plastic Black	F-7
544250	Heat Cable 250' Reel	I-1	591193	Switch - Fan, Rocker Black 1 Speed	G-6
549800	Plug Kit	I-1	591194	Globe Clear Barrel 6"	F-1, F-7
55060001	Rapid Wall 4' x 12' Panel White	B-24	591198	Switch - Fan, Rocker Black 2 Speed	G-7
55060002	Rapid Wall 4' x 12' Panel Grey	B-24	591203	Ceiling Fixture Gloss White 2 Lt	F-5
55060003	Rapid Wall 4' x 12' Panel Almond	B-24	591225	Dryer Receptacle 125 / 250 volt	F-10
55060004	Rapid Wall 12' Trim Kits With Hardware-white	B-24	591234	Globe Alabaster Bell	F-5
55060005	Rapid Wall 12' Trim Kits With Hardware-grey	B-24	5912421	Power Range Hood White, 12" x 42", Power	G-6
55060006	Rapid Wall 12' Trim Kits With Hardware-almond	B-24	591302	Globe Alabaster 6"	F-1
55060007	Rapid Wall 12' Trim Front Rail White	B-24	59131842	Ground Fault Circuit Interrupter Ivory, 15 Amp / 125 volt	F-10
55060008	Rapid Wall 12' Trim Front Rail Grey	B-24	59131851	Ground Fault Circuit Interrupter White, 15 Amp / 125 volt	F-10
55060009	Rapid Wall 12' Trim Front Rail Almond	B-24	59142	Electric Range Burner Plug-In 6"	G-7
55060010	Rapid Wall 12' Trim Back Rail White	B-24	5914511	Toggle Switch Single Pole White - 15amp; ½hp 120 volt	F-12
55060011	Rapid Wall 12' Trim Back Rail Grey	B-24	5914512	Toggle Switch Single Pole Ivory - 15amp; ½hp 120 volt	F-12

## INDEX BY PART NUMBER

591505	Roof Cap For Flat Roof Only . . . . .	F-10	60100003	Poly Film Sheeting 16' x 100' Black . . . . .	C-5, D-8
59152	Electric Range Burner 8" Plug-In . . . . .	G-7	60100004	Poly Film Sheeting 20' x 100' Black . . . . .	C-5, D-8
59153101	Rocker Switch-Sc Deco W/O Cover Plate . . . . .	F-11	60100DK	Batten ¾" x 8' Dark. . . . .	H-71
59153201	Duplex Receptacle-Duplex SC W/O Cover Plate . . . . .	F-11	60100LT	Batten ¾" x 8' Light . . . . .	H-71
59153211	Duplex Cover Plate-Double Deco-Snap On White . . . . .	F-11	60100WH	Batten ¾" x 8' White . . . . .	H-71
59153311	Rocker Switch Cover Plate - Receptacle-Snap On White . . . . .	F-11	60101	Bottomboard 30" x 100' Roll. . . . .	L-6
59153321	Rocker Switch Cover Plate-Double Deco-Snap On White . . . . .	F-11	601041	Grease Seal . . . . .	C-4
591567	Globe Alabaster 7" . . . . .	F-2	601050	Metal Flashing Aluminum 10" x 50' . . . . .	D-9, E-58
591575	Globe Etched Diamond Glass 9" . . . . .	F-3	6010501	Metal Flashing Galvanized 10" x 50' . . . . .	D-9, E-58
591579	Range Hood Outlet Adapter . . . . .	G-6	601100DK	Outside Corner 1" x 1" x 8' 8 Ft. Dark . . . . .	H-71
591671194	Porch Light W/Globe Black . . . . .	F-8	601100LT	Outside Corner 1" x 1" x 8' 8 Ft. Light. . . . .	H-71
59200	Bathroom Ceiling Fan Vertical Outlet, 10 ¾" R.O. Uses 7 ½" Diameter Duct . . . . .	F-9	601100WH	Outside Corner 8 Ft. 1" x 1" x 8' White . . . . .	H-71
59201	Roof Cap 7" . . . . .	F-10	601116	U-Bolt ½" - 20 Thread, 6 ½" Long . . . . .	C-4
5920154	Exhaust Fan . . . . .	G-5	6011218	Butyl Tape ½" x 1 ½" x 30' Black. . . . .	L-4
59202008	Ceiling Fixture Gloss White 6" 1 light . . . . .	F-1	601149	U-Bolt ½" - 20 Thread, 7" Long. . . . .	C-4
59202401	Ceiling Fixture Brushed Nickel 6" 1 light . . . . .	F-1	60121	Spring Tie Plate . . . . .	C-3
59215008	Ceiling Fixture Gloss White 9" 2 light . . . . .	F-3	601226	Teflon Thread Seal Tape ½" x 260" . . . . .	L-4
59215401	Ceiling Fixture Brushed Nickel 9" 2 light . . . . .	F-3	601310	Double Eye Cast Equalizer . . . . .	C-3
59220008	Ceiling Fixture Gloss White 7" 1 light . . . . .	F-2	601329	Steel Equalizer Cast. . . . .	C-3
59220401	Ceiling Fixture Brushed Nickel 7" 1 light . . . . .	F-2	601470	Bottom-board 172" x 70'. . . . .	L-6
59225040	Globe Alabaster 11" . . . . .	F-4	6014932	Fabric Flex Duct Strap 1 ¾" x 300' . . . . .	E-34
592262	Bathroom Ceiling Fan Assembly . . . . .	F-9	60152	Rim Clamp Plated . . . . .	C-4
59312	Bathroom Ceiling Fan Blade For 59200 . . . . .	F-9	60155550	Foam Sealer, 5 ½" x 50' . . . . .	D-9, L-6
59323401	Vanity Bar 18" Brushed Nickel . . . . .	F-6	601811	Shackle Link. . . . .	C-3
59361	Range Hood Fan Motor 115 volt . . . . .	G-6	60183430	Butyl Tape ¾" x ¾" x 30' Gray . . . . .	L-4
59382	Drip Pan & Ring Combination 6" . . . . .	G-8	602000	Foil Tape UL 181 2" x 60 Yards. . . . .	L-4
5939011	Toggle Switch Single Pole Cover Plate White - Smooth Surface . . . . .	F-12	60200DK	Batten 7/8" x 8' Dark. . . . .	H-71
5939012	Toggle Switch Single Pole Cover Plate Ivory - Smooth Surface . . . . .	F-12	60200LT	Batten 7/8" x 8' Light . . . . .	H-71
5939031	Duplex Receptacle . . . . .	F-12	60200WH	Batten 7/8" x 8' White . . . . .	H-71
5939032	Duplex Receptacle . . . . .	F-12	602084	Squeak - Ender . . . . .	L-5
59392	Combination Drip Pan & Ring 8" . . . . .	G-8	60211	Grease Cap . . . . .	C-5
59406502	Coach Porch Fixture Brushed Nickel . . . . .	F-7	602509	Aluminum Foil Tape 2" x 50 Yards. . . . .	L-4
5941046	Dishwasher Water Line Hook Up Kit . . . . .	G-3, G-9	60253235	Sign-Oversize Load-Mesh 20" x 7'. . . . .	C-5
594112	Smoke Alarm Off White, 5 ¼" Diameter . . . . .	F-9	6025580	Bearing Cone Inner 2 7/8" . . . . .	C-4
59523502	Porch Lantern Brushed Nickel . . . . .	F-7	602603	Cloth Duct Tape Silver 2" x 60 Yards. . . . .	L-5
5953201	Duplex Receptacle White, 15 amp / 125 volt . . . . .	F-12	602609	Cloth Duct Tape Black 2" x 60 Yards. . . . .	L-5
5953202	Duplex Receptacle Ivory, 15 amp / 125 volt . . . . .	F-12	602825	Bottom Closure Tape Roll 28" x 25' For Any Size Patch. . . . .	L-4
5955050	Range Receptacle U.L. Listed, 125 / 250 volt. . . . .	F-10	60285	Spring Hanger 3 ¼" High - 1 ¾" Wide . . . . .	C-3
59564	Exhaust Fan Replacement Grill . . . . .	G-5	602857B	Black Cloth Duct Tape UI 181 2" x 60 Yards. . . . .	L-4
59604016	Smoke Alarm Off White, 5 ¼" Diameter . . . . .	F-9	602857S	Silver Cloth Duct Tape UI 181 2" x 60 Yards. . . . .	L-4
596043	Rocker Switch White, 15 amp / 125 volt . . . . .	F-12	60286	Spring Hanger 1 ½" High - 1 ¾" Wide . . . . .	C-3
596044	Rocker Switch Ivory, 15 amp / 125 volt . . . . .	F-12	602881	Bottom-board Repair Kit . . . . .	L-6
59611500	Rocker Switch Cover Plate, Ivory. . . . .	F-12	60300DK	Shoe/Stop ¾" x 1 ¾" x 7' Dark . . . . .	H-71
59611507	Rocker Switch Cover Plate, White . . . . .	F-12	60300LT	Shoe/Stop ¾" x 1 ¾" x 7' Light . . . . .	H-71
596788	Porch Light W/Globe White . . . . .	F-8	60300WH	Shoe/Stop ¾" x 1 ¾" x 7' White . . . . .	H-71
598040	Liquid-Tight Conduit ½" Conduit 100'. . . . .	E-55	603028	Knob/Wall Guard 3 ¾" White. . . . .	H-61, H-72
598041	Liquid-Tight Conduit ¾" Conduit 100'. . . . .	E-55	603029	Knob/Wall Guard 5" White . . . . .	H-61, H-72
598042	Connector ½" Straight . . . . .	E-55	603150	Brace EZ Joist . . . . .	D-9
598043	Connector ¾" Straight . . . . .	E-55	603418	Butyl Tape ½" x ¾" x 30' Black . . . . .	L-4
598045	Connector ½" 90° Elbow . . . . .	E-55	60342	Spring Seat . . . . .	C-3
598046	Connector ¾" 90° Elbow . . . . .	E-55	603420	Electrical Tape Black ¾" x 20 Yards. . . . .	L-4
598064	A.C. Disconnect Switch Non-fusible 60 Amp. . . . .	E-55	603426	Teflon Thread Seal Tape ¾" x 260" . . . . .	L-4
598071	Liquid-Tight Conduit ½" x 4', #10 Wire . . . . .	E-55	603634	Exterior Gas Connector. . . . .	J-8
598073	Liquid-Tight Conduit ½" x 6', #10 Wire . . . . .	E-55	603827	Sag-Ender . . . . .	L-5
598077	Liquid-Tight Conduit ¾" x 6', #8 Wire . . . . .	E-55	60400	Flex-Mend 4" x 180' Roll . . . . .	L-4
598079	Liquid-Tight Conduit ¾" x 6', #6 Wire . . . . .	E-55	60400WH	Ceiling Beam 10 Ft. White . . . . .	H-72
59832401	Vanity Pendant Brushed Nickel 18" 2 light . . . . .	F-6	604011	WD-40 Lubricant 8 Ounce Spray Can . . . . .	L-5
59ER2050	Range Cord 50 Amp 4', 4 Wire . . . . .	F-9, G-9	60500DK	Shoe/Stop Dark ¾" x ¾" x 8' . . . . .	H-71
59VC0133-00	Bathroom Ceiling Fan Cover Lens For 59200 . . . . .	F-9	60500LT	Shoe/Stop light ¾" x ¾" x 8' . . . . .	H-71
60010002	Tub Molding . . . . .	J-17	60500WH	Shoe/Stop white ¾" x ¾" x 8' . . . . .	H-71
6001001	Rumble Button . . . . .	D-9	6050421	Sign-Metal 2 Side-Oversize . . . . .	C-5
600540	Light Bulb For Appliance 40 watt . . . . .	G-10	6051320	Plastic Flag Clips . . . . .	C-5
60100001	Poly Film White 14' x 300' Close Up Film U.V. . . . . .	C-5, D-8	6051622	Shock Cords 18" Length . . . . .	C-5, K-3
60100002	Poly Film Black 14' x 100'. . . . .	C-5, D-8	6052282	Nylon Tricot Flag 18" x 18", Red. . . . .	C-5
			6052602	Nylon Tricot Flag 18" Flag On ½" Staff. . . . .	C-5

## INDEX BY PART NUMBER

6052612	Flag On Staff	C-5	6419678	Storm Door Closer Black	H-61
6053244	Sign-Nylon-Multi Size	C-5	6419908	Push Button Latch 1 3/4" Black	H-61
6059363	Adjustable Outrigger Kit For 12' To 14' Wide (2 Pack)	D-9	641996	Chain Stop-Anodized	H-61
6059365	Adjustable Outrigger Kit For 16' Wide (2 Pack)	D-9	642478DK	Jeld-Wen Interior Door	H-70
60600	Bottom Closure Tape 6" x 180'	L-4	642478FEMBWH	Jeld-Wen Interior Door	H-70
60600DK	Shoe/Stop 7/16" x 1 1/16" x 7' Dark	H-71	642478LT	Jeld-Wen Interior Door	H-70
60600LT	Shoe/Stop 7/16" x 1 1/16" x 7' Light	H-71	642480DK	Jeld-Wen Interior Door	H-70
60600WH	Shoe/Stop 7/16" x 1 1/16" x 7' White	H-71	642480FEMBWH	Jeld-Wen Interior Door	H-70
60615DK	Batten 1 1/2" x 8' Dark	H-71	642480LT	Jeld-Wen Interior Door	H-70
60615LT	Batten 1 1/2" x 8' Light	H-71	6424806EWH	Jeld-Wen Interior Door	H-70
60615WH	Batten 1 1/2" x 8' White	H-71	642678DK	Jeld-Wen Interior Door	H-70
60620	Bottom Board Tape Black 2" x 36 Yards	L-5	642678LT	Jeld-Wen Interior Door	H-70
60620DK	Batten 2" x 8' Dark	H-71	6424786EWH	Jeld-Wen Interior Door	H-70
60620LT	Batten 2" x 8' Light	H-71	642680DK	Jeld-Wen Interior Door	H-70
60620wh	Batten 2" x 8' White	H-71	642680LT	Jeld-Wen Interior Door	H-70
60630WT	Crown Molding White 2 1/2" x 10'	H-72	642878DK	Jeld-Wen Interior Door	H-70
6067	Hex Locknut 3/16" x 18 Thread	C-3	642878FEMBWH	Jeld-Wen Interior Door	H-70
606748	Bearing Cone Outer 2"	C-4	642878LT	Jeld-Wen Interior Door	H-70
60700WH	Close-up Beam 12 Ft. White	H-72	6428786EWH	Jeld-Wen Interior Door	H-70
60723	Heavy Hex Lug Bolt Plated	C-4	642880DK	Jeld-Wen Interior Door	H-70
6073	Shackle Bolt Plated	C-3	642880FEMBWH	Jeld-Wen Interior Door	H-70
60736	Heavy Duty Lug Bolt	C-4	642880LT	Jeld-Wen Interior Door	H-70
60800DK	Casing 7 Ft. Dark	H-72	64287806EWH	Jeld-Wen Interior Door	H-70
60800LT	Casing 7 Ft. Light	H-72	643078DK	Jeld-Wen Interior Door	H-70
60800WH	Casing 7 Ft. White	H-72	643078FEMBWH	Jeld-Wen Interior Door	H-70
608120	Poly Film Sheeting Premium White 14' x 300'	C-5, D-8	643078LT	Jeld-Wen Interior Door	H-70
608146	Poly Film Sheeting Black 14' x 100'	C-5, D-8	6428786EWH	Jeld-Wen Interior Door	H-70
608166	Poly Film Sheeting Black 16' x 100'	C-5, D-8	643080DK	Jeld-Wen Interior Door	H-70
608206	Poly Film Sheeting Black 20' x 100'	C-5, D-8	643080FEMBWH	Jeld-Wen Interior Door	H-70
60850	Metal Flashing Aluminum 8" x 50'	D-9, E-58	643080LT	Jeld-Wen Interior Door	H-70
60900DK	Inside Corner 9 Ft. 3/16" x 1" x 8' Dark	H-71	64307806EWH	Jeld-Wen Interior Door	H-70
60900LT	Inside Corner 9 Ft. 3/16" x 1" x 8' Light	H-71	643278DK	Jeld-Wen Interior Door	H-70
60900WH	Inside Corner 9 Ft. 3/16" x 1" x 8' White	H-71	643278FEMBWH	Jeld-Wen Interior Door	H-70
612100	Hydraulic Bottle Jacks Repair Kits For 12 Ton Jack	D-6, K-4	643280DK	Jeld-Wen Interior Door	H-70
621125	Strap Crimp Tool for 1 1/4" Strap	D-7, K-2	643280FEMBWH	Jeld-Wen Interior Door	H-70
6212	Crimp Tool, 1/2" Tubing	J-38, K-2	643680DK	Jeld-Wen Interior Door	H-70
62125	Universal Tubing Cutter For 3/8"-3/4" Tubing	J-38, K-1	643680FEMBWH	Jeld-Wen Interior Door	H-70
621253	Hydraulic Bottle Jacks Repair Kits For 20 Ton Jack	D-6, K-4	648223	Door Knob Passage Lockset Polished Brass	H-62
6215	Tarp Straps 15" Length / Rubber	C-5, K-2	648327	Door Knob Privacy Lockset Polished Brass	H-62
6221	Tarp Straps 20" Length / Rubber	C-5, K-2	65112	White Rosette Screws 1 1/2"	K-1
6231	Tarp Straps 31" Length / Rubber	C-5, K-2	651434	Stove Bolts 1/4" x 3/4" W/Nut	D-9, I-2, K-1
623145	Utility Knife, 3 Position, Double Point Blades	K-2	65251	Rosettes 1" White	K-1
623340	Utility Knife, 3 Position with 3 Blades	K-2	6538450	Lag Screw Zinc 3/8" x 4"	D-8, K-2
6234	Crimp Tool, 3/4" Tubing	J-38, K-2	653850	Flat Washer 3/8" Zinc	D-8, K-2
623764	Snap Lock Punch 1/2" Throat Depth 8 1/2" Long	B-13, K-1	653851	Lag Screw 3/8" x 5" No Zinc	D-8, K-2
6248900	Anchor Speed Wrench	D-7, K-2	653852	Flat Washer 3/8" x 1-1/2" Zinc	D-8, K-2
62700	Pocket Penetrometer W/ Canvas Case	D-7, K-2	6538550	Lag Screw 3/8" x 5" Zinc	D-8, K-2
62701	Adapter Foot	D-7, K-2	6538650	Lag Screw 3/8" x 6" Zinc	D-8, K-2
6276412	Hydraulic Bottle Jacks 12 Ton, Lift: 9 7/16" 15 3/16"	D-6, K-4	655817	Panel Nails 1" Dark Brown	H-62, K-2
6276512	Hydraulic Bottle Jacks 12 Ton, Lift: 6 1 1/16" 10 7/16"	D-6, K-4	655861	Panel Nails 1" White	H-62, K-2
6276520	Hydraulic Bottle Jacks 20 Ton, Lift: 10 13/16" - 7 7/16"	D-6, K-4	655897	Panel Nails 1" Medium Brown	H-62, K-2
6277	Caulking Gun For All Standard Size Caulk	K-4, L-5	656217	Panel Nails 1 5/8" Dark Brown	H-62, K-2
62802	Magnetic Bit Holder, 1/4", Body Diameter 7/16", Stainless Steel	K-1	656261	Panel Nails 1 5/8" White	H-62, K-2
62807	Power Bits 5/32" Clutch	K-1	656297	Panel Nails 1 5/8" Medium Brown	H-62, K-2
62810	Power Bits #2 Phillips	K-1	6581100	Hex Head Screws 1/4", Zinc Plated & White Painted #8 x 1"	H-61, K-3
62814	Power Bits #2 Square Recess	K-1	6581101	Hex Head Screws 1/4", Zinc Plated & White Painted #8 x 1"	H-61, K-3
62816	Screw/Nut Driver, 6 In 1	K-1	658120	Hex Head Screws 1/4", Zinc Plated #8 x 1"	H-61, K-3
62823	Nut Setter 3/16" Long	K-1	6581201	Hex Head Screws 1/4", Painted #8 x 1" White	H-61, K-3
62824	Nut Setter 1/4" Long	K-1	65812591	Hex Head Screws 1/4", Painted #8 x 1 1/4" White	H-61, K-3
641101	Door Knob Stainless Steel Entry	H-62	6581501	Hex Head Screws 1/4", Painted #8 x 1 1/2" White	H-61, K-3
641102	Deadbolt Stainless Steel Single Cylinder	H-62	65815100	Hex Head Screws 1/4", Zinc Plated & White Painted #8 x 1-1/2"	H-61, K-3
641103	Door Knob Steel, Drive-In Set	H-62	65815101	Hex Head Screws 1/4", Zinc Plated & White Painted #8 x 1 1/2"	H-61, K-3
641104	Door Knob Brass Entry	H-62	6581520	Hex Head Screws 1/4", Zinc Plated #8 x 1 1/2"	H-61, K-2
641105	Deadbolt Polished Brass Single Cylinder	H-62			
641106	Door Knob Brass, Drive-In Set	H-62			

## INDEX BY PART NUMBER

6581750	Hex Head Screws ¼", Painted #8 x ¾" White	H-61, K-3	68K53254	Kinro Series 5700 Self Storing Storm Window	H-36
6582001	Hex Head Screws ¼", Zinc Plated #8 x 2"	H-61, K-2	68K53636	Kinro Series 5700 Self Storing Storm Window	H-36
6587510	Hex head Screws ¼", Zinc plated #8 x ¾"	H-61	68K53640	Kinro Series 5700 Self Storing Storm Window	H-36
65875100	Hex Head Screws ¼", Zinc Plated & White Painted #8 x ¾"	K-3	68K53654	Kinro Series 5700 Self Storing Storm Window	H-36
6587520	Hex Head Screws ¼", Zinc Plated #8 x ¾"	H-61, K-2	68K54027	Kinro Series 5700 Self Storing Storm Window	H-36
670118000	Window Latch Repair Kit For 18000 Series Windows	H-44	68K54036	Kinro Series 5700 Self Storing Storm Window	H-36
67019750	Window Latch Repair Kit For 9750 Series Windows	H-44	68K54054	Kinro Series 5700 Self Storing Storm Window	H-36
673711	Phillips Recess Screws 1" Silver	H-62	68K54627	Kinro Series 5700 Self Storing Storm Window	H-36
673712	Phillips Recess Screws 1" Brass	H-62	68K54640	Kinro Series 5700 Self Storing Storm Window	H-36
674218	Spring Door Stop/Brass 3"	H-61	68K54653	Kinro Series 5700 Self Storing Storm Window	H-36
678920	Drawer Single Track Set	H-72	68K54654	Kinro Series 5700 Self Storing Storm Window	H-36
68K21427	Kinro Series 9750 Vinyl Double Pane Single Hung Window	H-38	68K61421	Kinro Series 18000 Window Aluminum Vertical Slider Main Window	H-34
68K21427G	Kinro Series 9750 Vinyl Double Pane Single Hung Window	H-38	68k614210BS	Kinro Series 18000 Window Aluminum Vertical Slider Main Window	H-34
68K21427OBS	Kinro Series 9750 Vinyl Double Pane Single Hung Window	H-38	68K61427	Kinro Series 18000 Window Aluminum Vertical Slider Main Window	H-34
68K21439	Kinro Series 9750 Vinyl Double Pane Single Hung Window	H-38	68K61427OBS	Kinro Series 18000 Window Aluminum Vertical Slider Main Window	H-34
68K21440	Kinro Series 9750 Vinyl Double Pane Single Hung Window	H-38	68K61440	Kinro Series 18000 Window Aluminum Vertical Slider Main Window	H-34
68K21440G	Kinro Series 9750 Vinyl Double Pane Single Hung Window	H-38	68K614400BS	Kinro Series 18000 Window Aluminum Vertical Slider Main Window	H-34
68K21453	Kinro Series 9750 Vinyl Double Pane Single Hung Window	H-38	68K61454	Kinro Series 18000 Window Aluminum Vertical Slider Main Window	H-34
68K22440	Kinro Series 9750 Vinyl Double Pane Single Hung Window	H-38	68K61827	Kinro Series 18000 Window Aluminum Vertical Slider Main Window	H-34
68K23027	Kinro Series 9750 Vinyl Double Pane Single Hung Window	H-38	68K62227	Kinro Series 18000 Window Aluminum Vertical Slider Main Window	H-34
68K23027G	Kinro Series 9750 Vinyl Double Pane Single Hung Window	H-38	68K62427	Kinro Series 18000 Window Aluminum Vertical Slider Main Window	H-34
68K23039	Kinro Series 9750 Vinyl Double Pane Single Hung Window	H-38	68K62427WL	Kinro Series 18000 Window Aluminum Vertical Slider Main Window	H-34
68K23040	Kinro Series 9750 Vinyl Double Pane Single Hung Window	H-38	68K62440	Kinro Series 18000 Window Aluminum Vertical Slider Main Window	H-34
68K23040G	Kinro Series 9750 Vinyl Double Pane Single Hung Window	H-38	68K63021	Kinro Series 18000 Window Aluminum Vertical Slider Main Window	H-34
68K23053	Kinro Series 9750 Vinyl Double Pane Single Hung Window	H-38	68K63027	Kinro Series 18000 Window Aluminum Vertical Slider Main Window	H-34
68K23053G	Kinro Series 9750 Vinyl Double Pane Single Hung Window	H-38	68k63027WI	Kinro Series 18000 Window Aluminum Vertical Slider Main Window	H-34
68K23054	Kinro Series 9750 Vinyl Double Pane Single Hung Window	H-38	68K63030	Kinro Series 18000 Window Aluminum Vertical Slider Main Window	H-34
68K23054G	Kinro Series 9750 Vinyl Double Pane Single Hung Window	H-38	68K63036	Kinro Series 18000 Window Aluminum Vertical Slider Main Window	H-34
68K23058	Kinro Series 9750 Vinyl Double Pane Single Hung Window	H-38	68K63040	Kinro Series 18000 Window Aluminum Vertical Slider Main Window	H-34
68K23060	Kinro Series 9750 Vinyl Double Pane Single Hung Window	H-38	68K63040W	Kinro Series 18000 Window Aluminum Vertical Slider Main Window	H-34
68K23068	Kinro Series 9750 Vinyl Double Pane Single Hung Window	H-38	68k63040WI	Kinro Series 18000 Window Aluminum Vertical Slider Main Window	H-34
68K23627	Kinro Series 9750 Vinyl Double Pane Single Hung Window	H-38	68K63052	Kinro Series 18000 Window Aluminum Vertical Slider Main Window	H-34
68K23640	Kinro Series 9750 Vinyl Double Pane Single Hung Window	H-38	68K63053	Kinro Series 18000 Window Aluminum Vertical Slider Main Window	H-34
68K23653	Kinro Series 9750 Vinyl Double Pane Single Hung Window	H-38	68K63054	Kinro Series 18000 Window Aluminum Vertical Slider Main Window	H-34
68K23654	Kinro Series 9750 Vinyl Double Pane Single Hung Window	H-38	68K63054W	Kinro Series 18000 Window Aluminum Vertical Slider Main Window	H-34
68K23654G	Kinro Series 9750 Vinyl Double Pane Single Hung Window	H-38	68K63054WL	Kinro Series 18000 Window Aluminum Vertical Slider Main Window	H-34
68K24054	Kinro Series 9750 Vinyl Double Pane Single Hung Window	H-38	68K63058	Kinro Series 18000 Window Aluminum Vertical Slider Main Window	H-34
68K24627	Kinro Series 9750 Vinyl Double Pane Single Hung Window	H-38	68K63060	Kinro Series 18000 Window Aluminum Vertical Slider Main Window	H-34
68K24639	Kinro Series 9750 Vinyl Double Pane Single Hung Window	H-38			
68K24640	Kinro Series 9750 Vinyl Double Pane Single Hung Window	H-38			
68K24640G	Kinro Series 9750 Vinyl Double Pane Single Hung Window	H-38			
68K24653	Kinro Series 9750 Vinyl Double Pane Single Hung Window	H-38			
68K24654	Kinro Series 9750 Vinyl Double Pane Single Hung Window	H-38			
68K24654G	Kinro Series 9750 Vinyl Double Pane Single Hung Window	H-38			
68K33014	Kinro Series 18000 Horizontal Slider Aluminum Main Window	H-34			
68K33027	Kinro Series 18000 Horizontal Slider Aluminum Main Window	H-34			
68K33040	Kinro Series 18000 Horizontal Slider Aluminum Main Window	H-34			
68K34627	Kinro Series 18000 Horizontal Slider Aluminum Main Window	H-34			
68K34640	Kinro Series 18000 Horizontal Slider Aluminum Main Window	H-34			
68K51421	Kinro Series 5700 Self Storing Storm Window	H-36			
68K51427	Kinro Series 5700 Self Storing Storm Window	H-36			
68K51440	Kinro Series 5700 Self Storing Storm Window	H-36			
68K51454	Kinro Series 5700 Self Storing Storm Window	H-36			
68K51827	Kinro Series 5700 Self Storing Storm Window	H-36			
68K52427	Kinro Series 5700 Self Storing Storm Window	H-36			
68K52440	Kinro Series 5700 Self Storing Storm Window	H-36			
68K53021	Kinro Series 5700 Self Storing Storm Window	H-36			
68K53027	Kinro Series 5700 Self Storing Storm Window	H-36			
68K53030	Kinro Series 5700 Self Storing Storm Window	H-36			
68K53036	Kinro Series 5700 Self Storing Storm Window	H-36			
68K53040	Kinro Series 5700 Self Storing Storm Window	H-36			
68K53052	Kinro Series 5700 Self Storing Storm Window	H-36			
68K53053	Kinro Series 5700 Self Storing Storm Window	H-36			
68K53054	Kinro Series 5700 Self Storing Storm Window	H-36			
68K53058	Kinro Series 5700 Self Storing Storm Window	H-36			







## INDEX BY PART NUMBER

69K83476ROWAO	Kinro Series 5600 Storm Door . . . . .	H-28	9536.7351	Blower-Nordyne Electric E2eh Only . . . . .	E-27
69K83476ROWCO	Kinro Series 5600 Storm Door . . . . .	H-28	9536.7411	Coil Cabinet W/ Filter . . . . .	E-27
69K83476ROWch	Kinro Series 5900 Heavy Duty Storm Door. . . . .	H-30	C8DAM01830U-B	Micro-Channel Coil . . . . .	E-12
69K83476ROWFO	Kinro Series 5600 Storm Door . . . . .	H-28	C8DAM024U-B	Micro-Channel Coil . . . . .	E-18
69K83478LOWCO	Kinro Series 5600 Storm Door . . . . .	H-28	C8DAM030U-B	Micro-Channel Coil . . . . .	E-18
69K83478ROWCO	Kinro Series 5600 Storm Door . . . . .	H-28	C8DAM036U-B	Micro-Channel Coil . . . . .	E-12, E-18
69K83480LOWCO	Kinro Series 5600 Storm Door . . . . .	H-28	C8DAMx24U-B	Micro-Channel Coil . . . . .	E-14, E-16, E-18
69K83480LOWch	Kinro Series 5900 Heavy Duty Storm Door. . . . .	H-30	C8DAMx30U-B	Micro-Channel Coil . . . . .	E-14, E-16, E-18
69K83480ROWCO	Kinro Series 5600 Storm Door . . . . .	H-28	C8DAMx36U-B	Micro-Channel Coil . . . . .	E-14, E-16, E-18
69K83480ROWch	Kinro Series 5900 Heavy Duty Storm Door. . . . .	H-30	C8DAMx42U-B	Micro-Channel Coil . . . . .	E-14, E-16, E-18
69K83676LOWCO	Kinro Series 5600 Storm Door . . . . .	H-28	C8DAMx48U-B	Micro-Channel Coil . . . . .	E-14, E-18
69K83676ROWCO	Kinro Series 5600 Storm Door . . . . .	H-28	C8DAMx49U-B	Micro-Channel Coil . . . . .	E-16, E-18
69K83680LOWCO	Kinro Series 5600 Storm Door . . . . .	H-28	C8QAM024U-B	Micro Channel Coil . . . . .	E-4, E-18
69K83680ROWCO	Kinro Series 5600 Storm Door . . . . .	H-28	C8QAM030U-B	Micro Channel Coil . . . . .	E-4, E-18
69K83876LOWCO	Kinro Series 5600 Storm Door . . . . .	H-28	C8QAM036U-B	Micro Channel Coil . . . . .	E-4, E-18
69K83876LOWch	Kinro Series 5900 Heavy Duty Storm Door. . . . .	H-30	C8QAMx24U-B	Micro Channel Coil . . . . .	E-6, E-8, E-18
69K83876ROWCO	Kinro Series 5600 Storm Door . . . . .	H-28	C8QAMx30U-B	Micro Channel Coil . . . . .	E-6, E-8, E-18
69K83876ROWch	Kinro Series 5900 Heavy Duty Storm Door. . . . .	H-30	C8QAMx36U-B	Micro Channel Coil . . . . .	E-6, E-8, E-18
69K83880LOWCO	Kinro Series 5600 Storm Door . . . . .	H-28	C8QAMx42U-B	Micro Channel Coil . . . . .	E-6, E-8, E-18
69K83880ROWCO	Kinro Series 5600 Storm Door . . . . .	H-28	C8QAMx48U-B	Micro-Channel Coil . . . . .	E-18
7336.5801	Duct Connector W/ Damper (1 Required For Install) . . . . .	E-33	C8QAMx49U-B	Micro-Channel Coil . . . . .	E-8, E-18
7900.6021	Control Package For Adding AC/HP W/2 Wire (Heat Only) . . . . .	E-28	H3232-4	Pad A/C 32 x 32 x 4"-150mph . . . . .	E-56
7900.6051	Blower-Revolv Gas DGAT, 76-7900 Only 4 Ton AC . . . . .	E-27	H3636-4	Pad A/C 36 x 36 x 4"-150mph . . . . .	E-56
7900.6061	Blower-Revolv Gas DGAT, 76-7900 Only 3.5 Ton AC . . . . .	E-27	H3652-4	Pad A/C 36 x 52 x 4"-150mph . . . . .	E-56
7900.7741	Blower-Revolv Gas DGAA, DGAH-4 Ton . . . . .	E-27	H3865-4	Pad A/C 38 x 65 x 4"-150mph . . . . .	E-56
7900.7751	Blower-Revolv Gas DGAA, DGAH-5 Ton . . . . .	E-27	H3HK005H-01C	Heat Strip Kit 5kw . . . . .	E-32
901083	Backflow Damper Gas/Oil Furnace . . . . .	E-34, E-45, E-56	H3HK010H-01C	Heat Strip Kit 10kw . . . . .	E-30, E-32
901935	Roof Jack Extensions 10" Internal . . . . .	E-45, E-46	H3HK015H-01C	Heat Strip Kit 15kw . . . . .	E-32
901937	Roof Jack Extensions 18" External . . . . .	E-45, E-46	H3HK020H-21C	Heat Strip Kit 20kw . . . . .	E-30, E-32
901987A	Plenum/Duct Connectors 11.25 x 13.50 x 0.88 . . . . .	E-45, E-47	MHSC200T	Revolv Service Coil . . . . .	E-24
901988A	Plenum/Duct Connectors 11.25 x 13.50 x 2.00 . . . . .	E-45, E-47	MHSC300T	Revolv Service Coil . . . . .	E-24
901989A	Plenum/Duct Connectors 11.25 x 13.50 x 4.25 . . . . .	E-45, E-47	MHSC400T	Revolv Service Coil . . . . .	E-24
901990A	Plenum/Duct Connectors 11.25 x 13.50 x 6.25 . . . . .	E-45, E-47	M5SB-066A BW	Oil, downflow, 66KBTU, with cabinet, 3 ton blower. . . . .	E-44
901991A	Plenum/Duct Connectors 11.25 x 13.50 x 8.25 . . . . .	E-45, E-47	M5SB-086A BW	Oil, downflow, 86KBTU, with cabinet, 3 ton blower. . . . .	E-44
901992A	Plenum/Duct Connectors 11.25 x 13.50 x 10.25 . . . . .	E-45, E-47	RE9D10C4	Electric 10kw Downflow W/Cabinet . . . . .	E-36
901993A	Plenum/Duct Connectors 11.25 x 13.50 x 12.25 . . . . .	E-45, E-47	RE9D12C4	Electric 12kw Downflow W/Cabinet . . . . .	E-36
902095	Backflow Damper Automatic Cavity . . . . .	E-45	RE9D15C4	Electric 15kw Downflow W/Cabinet . . . . .	E-36
902521	Ceiling Rings (2 Piece Adjustable). . . . .	E-45	RE9D17C4	Electric 17kw downflow W/Cabinet . . . . .	E-36
902681A	Plenum/Duct Connectors 11.25 x 13.50 x 6.25 . . . . .	E-45, E-47	RE9D20C4	Electric 20kw Downflow W/Cabinet . . . . .	E-36
903107	Roof Jack Extensions 16" Internal . . . . .	E-45, E-46	RE9D23C4	Electric 23kw Downflow W/Cabinet . . . . .	E-36
903656A	Roof Jack Crown Assembly . . . . .	E-46	RE9U10C4	Electric 10kw Upflow W/Cabinet . . . . .	E-36
903658	Roof Jack FAW 1523-0A 15" - 23" . . . . .	E-46	RE9U12C4	Electric 12kw Upflow W/Cabinet . . . . .	E-36
903659	Roof Jack FAW 2135-0A 21" - 35" . . . . .	E-46	RE9U15C4	Electric 15kw Upflow W/Cabinet . . . . .	E-36
903660	Roof Jack FAW 2747-0A 27" - 47" . . . . .	E-46	RE9U17C4	Electric 17kw Upflow W/Cabinet . . . . .	E-36
903662	Roof Jack SAW2135-2A 21" - 35" . . . . .	E-46	RE9U20C4	Electric 20kw Upflow W/Cabinet . . . . .	E-36
903663	Roof Jack SAW2747-2A 27" - 47" . . . . .	E-46	RE9U23C4	Electric 23kw Upflow W/Cabinet . . . . .	E-36
903664	Roof Jack SAW3563-2A 35" - 63" . . . . .	E-46	RE9X10N4	Electric 10kw W/O Cabinet . . . . .	E-38
903665A	Roof Jack SAW3563-4A 35" - 63" . . . . .	E-46	RE9X12N4	Electric 12kw W/O Cabinet . . . . .	E-38
903666	Roof Jack SAW5195-4A 51" - 95" . . . . .	E-46	RE9X15N4	Electric 15kw W/O Cabinet . . . . .	E-38
903678A	Roof Jack SAW2747-4A 27" - 47" . . . . .	E-46	RE9X17N4	Electric 17kw W/O Cabinet . . . . .	E-38
903893	Sloped Roof Flashings 2 1/2" In 12" . . . . .	E-45	RE9X20N4	Electric 20kw W/O Cabinet . . . . .	E-38
903894	Sloped Roof Flashings 3" In 12" . . . . .	E-45	RE9X23N4	Electric 23kw W/O Cabinet . . . . .	E-38
903895	Sloped Roof Flashings 4" In 12" . . . . .	E-45	RG1D56C3	Furnace Gas-80%, Downflow, 56kBTU W/Cabinet, 3 Ton Blower . . . . .	E-40
904106	Vent Transition Rg 7 - 8" . . . . .	E-47	RG1D56C4	Furnace Gas-80%, Downflow, 56kBTU W/Cabinet, 4 Ton Blower . . . . .	E-40
904620A	Upflow Stand . . . . .	E-47	RG1D56N3	Furnace Gas-80%, Downflow, 56kBTU No Cabinet, 3 Ton Blower . . . . .	E-40
911969A	Coil Cabinet (20") . . . . .	E-45, E-47	RG1D56N4	Furnace Gas-80%, Downflow, 56kBTU No Cabinet, 4 Ton Blower . . . . .	E-40
913350	Circuit Adapter 4-Pole Single . . . . .	E-30, E-32	RG1D70C3	Furnace Gas-80%, Downflow, 70kBTU W/Cabinet, 3 Ton Blower . . . . .	E-40
913554	Circuit Breaker Single Phase (2-Pole) . . . . .	E-30, E-32	RG1D70C4	Furnace Gas-80%, Downflow, 70kBTU W/Cabinet, 4 Ton Blower . . . . .	E-40
913556	Circuit Adapter 6-Pole Single . . . . .	E-30, E-32			
920638	Roof Jack SAW5195-2A 51" - 95" . . . . .	E-46			
921784A	Furnace Filter Kit 15" x 17" Mc 18" . . . . .	E-58			
921785A	Furnace Filter Kit 17" x 21" Mc 24" . . . . .	E-58			
922594	Coil Cabinet (26") . . . . .	E-45, E-47			
9336.7901	Blower-Nordyne Gas M1g-M1s Series-2-4.0 Ton . . . . .	E-27			
9536.7301	Blower-Nordyne Electric All FExx Series, E1EH . . . . .	E-27			



## INDEX BY PART NUMBER

RG1D70N3	Furnace Gas-80%, Downflow, 70kBTU No Cabinet, 3 Ton Blower	E-40	RSC1324	Split System AccuCharge® Air Conditioners 13 SEER	E-4
RG1D70N4	Furnace Gas-80%, Downflow, 70kBTU No Cabinet, 4 Ton Blower	E-40	RSC1330	Split System AccuCharge® Air Conditioners 13 SEER	E-4, E-18
RG1D77C3	Furnace Gas-80%, Downflow, 77kBTU W/Cabinet, 3 Ton Blower	E-40	RSC1336	Split System AccuCharge® Air Conditioners 13 SEER	E-4, E-18
RG1D77C4	Furnace Gas-80%, Downflow, 77kBTU W/Cabinet, 4 Ton Blower	E-40	RSC1342	Split System AccuCharge® Air Conditioners 13 SEER	E-4
RG1D77N3	Furnace Gas-80%, Downflow, 77kBTU No Cabinet, 3 Ton Blower	E-40	RSC1348	Split System AccuCharge® Air Conditioners 13 SEER	E-4
RG1D77N4	Furnace Gas-80%, Downflow, 77kBTU No Cabinet, 4 Ton Blower	E-40	RSC1424	Split System AccuCharge® Air Conditioners 13 SEER	E-6, E-18
RG1D90C3	Furnace Gas-80%, Downflow, 90kBTU W/Cabinet, 3 Ton Blower	E-40	RSC1430	Split System AccuCharge® Air Conditioners 13 SEER	E-6, E-18
RG1D90C4	Furnace Gas-80%, Downflow, 90kBTU W/Cabinet, 4 Ton Blower	E-40	RSC1436	Split System AccuCharge® Air Conditioners 13 SEER	E-6, E-18
RG1D90N3	Furnace Gas-80%, Downflow, 90kBTU No Cabinet, 3 Ton Blower	E-40	RSC1442	Split System AccuCharge® Air Conditioners 13 SEER	E-6, E-18
RG1D90N4	Furnace Gas-80%, Downflow, 90kBTU No Cabinet, 4 Ton Blower	E-40	RSC1448	AccuCharge®—A/C 14 SEER (TXV)	E-18
RG7D45C4	Furnace Gas-95%, Downflow, 45kBTU, W/Cabinet, 4 Ton Blower	E-42	RSH1424	Split System QC Heat Pumps 14 SEER	E-8, E-18
RG7D45N4	Furnace Gas-95%, Downflow, 45kBTU, No Cabinet, 4 Ton Blower	E-42	RSH1430	Split System QC Heat Pumps 14 SEER	E-8, E-18
RG7D60C4	Furnace Gas-95%, Downflow, 60kBTU, W/Cabinet, 4 Ton Blower	E-42	RSH1436	Split System QC Heat Pumps 14 SEER	E-8, E-18
RG7D60N4	Furnace Gas-95%, Downflow, 60kBTU, No Cabinet, 4 Ton Blower	E-42	RSH1442	Split System QC Heat Pumps 14 SEER	E-8, E-18
RG7D72C4	Furnace Gas-95%, Downflow, 72kBTU, W/Cabinet, 4 Ton Blower	E-42	RSH1448	Split System QC Heat Pumps 14 SEER	E-8, E-18
RG7D72N4	Furnace Gas-95%, Downflow, 72kBTU, No Cabinet, 4 Ton Blower	E-42	RT4BE-024KA	Split System Sweat Fit Heat Pumps 14 SEER	E-16, E-18
M5D66C3	Furnace Oil, Downflow, 66kBTU, With Cabinet, 3 Ton Blower	E-44	RT4BE-030KA	Split System Sweat Fit Heat Pumps 14 SEER	E-16, E-18
M5D86C3	Furnace Oil, Downflow, 86kBTU, With Cabinet, 3 Ton Blower	E-44	RT4BE-036KA	Split System Sweat Fit Heat Pumps 14 SEER	E-16, E-18
RPC1418	Revolv Packaged Air Conditioners 14 SEER, 35" x 49" x 22.2"	E-30	RT4BE-042K	Split System Sweat Fit Heat Pumps 14 SEER	E-16
RPC1424	Revolv Packaged Air Conditioners 14 SEER, 35" x 49" x 22.2"	E-30	RT4BE-042KA	Sweat Fit-H/P 14 SEER (TXV)	E-18
RPC1430	Revolv Packaged Air Conditioners 14 SEER, 35" x 49" x 22.2"	E-30	RT4BE-048K	Split System Sweat Fit Heat Pumps 14 SEER	E-16
RPC1436	Revolv Packaged Air Conditioners 14 SEER, 35" x 49" x 22.2"	E-30	RT4BE-048KA	Sweat Fit-H/P 14 SEER (TXV)	E-18
RPC1442	Revolv Packaged Air Conditioners 14 SEER, 35" x 49" x 30.2"	E-30			
RPC1448	Revolv Packaged Air Conditioners 14 SEER, 35" x 49" x 30.2"	E-30			
RPC1460	Revolv Packaged Air Conditioners 14 SEER, 35" x 49" x 34.2"	E-30			
RPH1424	Packaged Heat Pump 14 SEER, 35" x 49" x 30.2"	E-32			
RPH1430	Packaged Heat Pump 14 SEER, 35" x 49" x 30.2"	E-32			
RPH1436	Packaged Heat Pump 14 SEER, 35" x 49" x 30.2"	E-32			
RPH1442	Packaged Heat Pump 14 SEER, 35" x 49" x 30.2"	E-32			
RPH1448	Packaged Heat Pump 14 SEER, 35" x 63" x 38.2"	E-32			
RPH1460	Packaged Heat Pump 14 SEER, 35" x 63" x 38.2"	E-32			
RS4BD-024K	Sweat Fit-A/C 13 SEER (Piston)	E-18			
RS4BD-024KB	Split System Sweat Fit Air Conditioners 13 SEER	E-12			
RS4BD-030KB	Sweat Fit-A/C 13 SEER (Piston)	E-18			
RS4BD-030KB	Split System Sweat Fit Air Conditioners 13 SEER	E-12			
RS4BD-036K	Sweat Fit-A/C 13 SEER (Piston)	E-18			
RS4BD-036KB	Split System Sweat Fit Air Conditioners 13 SEER	E-12			
RS4BD-042KB	Split System Sweat Fit Air Conditioners 13 SEER	E-12			
RS4BD-048KB	Micro-Channel Coil	E-12			
RS4BE-024K	Sweat Fit-A/C 14 SEER (TXV)	E-18			
RS4BE-024KA	Split System Sweat Fit Air Conditioners 14 SEER	E-14			
RS4BE-030K	Sweat Fit-A/C 14 SEER (TXV)	E-18			
RS4BE-030KA	Split System Sweat Fit Air Conditioners 14 SEER	E-14			
RS4BE-036K	Sweat Fit-A/C 14 SEER (TXV)	E-18			
RS4BE-036KA	Split System Sweat Fit Air Conditioners 14 SEER	E-14			
RS4BE-042K	Sweat Fit-A/C 14 SEER (TXV)	E-18			
RS4BE-048K	Sweat Fit-A/C 14 SEER (TXV)	E-18			
RS6BF-042K	Split System Sweat Fit Air Conditioners 14 SEER	E-14			
RS6BF-048K	Split System Sweat Fit Air Conditioners 14 SEER	E-14			





Engineered specifically for mobile home installation and optimum performance.

*RG1 Series  
Gas-Oil  
Downflow  
Furnace*

*RE Series  
Electric  
Downflow  
Furnace*

*14 S.E.E.R.  
Condenser*

*RG7 Series  
Gas  
Downflow  
Furnace*



The Mobile Home Expert!

800.945.4440  
www.stylecrestinc.com